

ACCESSORIES FOR INDUSTRY



- 01 OCCHIELLI / RANELLE
- 03 CAVALLOTTI / CONTROPIASTRE
- 05 CHIUSURE
- 07 GANCI / CONTROPIASTRE
- 09 RIVETTI
- 11 CAVO TIR / CORDA ELASTICA / TRECCIA
- 13 CINGHIE / CINTURINI / NASTRI
- 15 TENDITELO ELASTICI
- 18 ANELLI / MEZZANELLI
- 25 CARRUCOLE / GUIDE / ACCESSORI
- 30 NASTRINO / TUBETTO / PROFILI IN PVC
- 32 PROFILI PVC - ALLUMINIO / GUAINE / PORTONI INDUSTRIALI
- 40 SISTEMI DI ANCORAGGIO E SOLLEVAMENTO
- 45 SISTEMI DI TENSIONAMENTO
- 50 PRONTOCAR
- 70 CRISTAL
- 75 RETI
- 78 CERNIERE / CHIUSURA A STRAPPO / FILO PER CUCIRE
- 80 PUNZONI / FUSTELLE
- 85 ACCESSORI VARI / TORCHI / SALDATORI
- 90 OCCHIELLATRICI



Indice dei prodotti

01 OCCHIELLI / RANELLE

cod	pag	
0101	10	Rotondi alluminio serie VL
0102	10	Rotondi ferro nichel serie VL
0104	10	Rotondi zinco nichel serie VL ranella per macchina
0105	11	Rotondi ottone serie VL
0106	11	Rotondi ottone nichel serie VL
0108	12	Rotondi acciaio inox serie VL
0110	12	Rotondi aluzinco serie VL
0110	12	Rotondi aluzinco ranella per macchina serie VL
0111	13	Rotondi alluminio ranella per macchina serie VL
0116	13	Rotondi ottone nichel ranella per macchina serie VL
0110	13	Rotondi aluzinco serie E (DIN)
0110	14	Rotondi aluzinco serie E (DIN)
0105	14	Rotondi ottone serie E (DIN)
0106	15	Rotondi ottone nichel serie E (DIN)
0108	15	Rotondi acciaio inox serie E (DIN)
016	16	Rotondi serie BA e OB
0120	17	Ovali
0120	18	Ovali serie E (DIN)
0150	18	Rettangolari
0170	19	Occhielli per stampa digitale
0180	19	Ranella concava
B22	19	Occhielli PVC montaggio rapido

03 CAVALLOTTI / CONTROPIASTRE

cod	pag	
0301	21	Cavallotti export 2 fori
0301	21	Cavallotti export 2 fori tondo
0301	21	Cavallotti export 2 fori pipa
0302	21	Cavallotti standard
0302	22	Contropiastre
0303	23	Cavallotti 2 fori
0303	23	Cavallotti 2 fori tondo
0304	23	Cavallotti 4 fori
0304	24	Cavallotti e contropiastre
0304	24	Cavallotti 4 fori
0305	25	Cavallotti a molla con boccola sicurezza
0305	25	Cavallotti a molla
0305	25	Cavallotti a molla snodati
0305	26	Cavallotti a molla in nylon

0305	26	Cavallotti a molla in nylon doppia altezza
0306	27	Cavallotti snodati saldati
0307	27	Anelli a pera
0307	27	Anelli a pera sagomati
0307	28	Piastre per anelli a pera
0310	28	Bandelle TIR f.z.
0315	29	Cavallotti jeep campagnola
0315	29	Cavallotti jeep

05 CHIUSURE

cod	pag	
0501	31	Loxx
0502	34	Capicorda
8007	34	Punzoni a martello capicorda
0503	35	Chiusure jeep
0504	36	Clipmax
0505	38	Bottoni
8505	38	Pinze
0506	39	Turniquet Europeo
0506	41	Turniquet
0506	43	DOT
0507	47	Punti P7
0508	47	Fascette per corda elastica
0508	48	Fascette ovali per corda elastica
0508	48	Capocorda con molla simplex
0508	48	Capocorda senza molla simplex
0515	49	Molle simplex
0511	49	Moschettoni
0513	50	Moschettoni nylon
0514	50	Moschettone rotante
0512	51	Moschettoni acciaio Inox
0703	51	Moschettoni nylon
0520	52	Chiusure speciali
0520	52	Chiusure speciali piastre ST C/AN
0520	53	Chiusure speciali ranelle bombate
016	53	Calamite
0525	54	Maniglie f.z.
0525	55	Maniglie acciaio inox 304
0525	56	Maniglie lamiera elettrozincata + mat. plastico
0525	57	Maniglie plastica
0525	58	Chiavistelli
60	60	Chiusure complete - Esempio

07 GANCI / CONTROPIASTRE

cod	pag	
0701	63	Ganci S
0703	65	Ganci sponda
0703	54	Ganci S chiusi per gommoni
0703	66	Ganci S stretti
0703	66	Ganci sponda S larghi
0703	66	Ganci per copricanotti
0703	66	Ganci sponda doppi per corda elastica Ø 8mm
0703	67	Ganci tondi per corda elastica
0703	67	Bottone
0703	67	Moschettoni
0703	68	Ganci sponda
0705	68	Ganci Zig Zag
0705	70	Piastrine
0706	71	Piastrine triangolari
0707	72	Ganci cobra
0709	73	Ganci cestello
0709	74	Clip Serravela
0709	74	Ganci tenditelo con sicura polipropilene
0720	74	Ganci per striscioni
0725	75	Ruck Zuck
0730	75	Ganci zaino
0732	76	Ganci per guaina
0735	77	Ganci a sfera
0735	77	Ganci a T
0735	78	Ganci laterali
0735	78	Ganci a T
2550	78	Carrelli nylon

09 RIVETTI

cod	pag	
0901	80	Rivetti testa e gambo
0902	80	Rivetti doppia calotta
0905	81	Rivetti autoperforanti
0940	81	Rivetti calottati autoperforanti
0960	81	Collare e bulloni a strappo
0950	82	Rivetti a strappo alluminio/acciaio
8590	83	Rivettatrici

11 CAVO TIR / CORDA ELASTICA TRECCIA

cod	pag	
1101	86	Cavo TIR acciaio su rotolo
1101	86	Cavo TIR pesante su rotolo
1105	87	Cavo TIR acciaio con capoporda
1110	87	Cavo TIR nylon su rotolo
1115	88	Cavo TIR nylon con capocorda
1118	88	Tondini
1120	88	Corda elastica su rotolo
1120	92	Corda elastica multibava su rotolo
1120	92	Corda elastica nautica su rotolo
1130	93	Cinghia elastica per tappezzeria
1140	93	Treccia vela poliesteri
1142	94	Treccia vela piatta poliesteri alta tenacità
1144	95	Corda liscia ritorta poliesteri

1145	95	Trecce speciali
1158	95	Treccia Riloga polipropilene
1158	96	Treccia Veneziana polipropilene
1159	96	Desmoplan PVC elasticizzato

13 CINGHIE / CINTURINI / NASTRI

cod	pag	
0503	98	Cinturini PVC
1345	98	Cinghia TIR PVC
1345	98	Cinghia PVC
1301	99	Cappette PVC
1301	99	Punte PVC
1303	100	Cinturini PVC
1304	100	Asole corda piatta poliesteri
1305	101	Cappette PVC
1335	101	Fibbie cinturini
1326	102	Cinturini poliesteri con fibbia zama
1335	102	Fibbie zama
1335	102	Pinzetta zama
1335	103	Fibbie a scatto nylon
1335	103	Fibbie AISI 316
1338	103	Fibbie AISI 316
1335	104	Fibbie dentate nylon
1336	104	Passanti doppi nylon
1336	104	Passanti singoli nylon
1340	105	Rinforzi tenditelo con anello f.z.
5010	105	Cinghie saldabili PVC con asole
1340	105	Rinforzo quadrato
1340	106	Rinforzo rotondo
1340	106	Rinforzi su rotolo
1342	106	Cinghia saldabile asolata
1345	106	Cinghie in PVC
1350	107	Nastri polipropilene
1351	107	Nastri spigatela
1355	108	Nastri poliesteri canatè
1302	108	Ganci bandiere
1365	108	Nastri poliesteri a bande
1365	109	Nastri cintura di sicurezza
1366	109	Nastri poliesteri HT
1367	109	Nastri spigati tubolari multifibra di poliesteri HT
1370	110	Nastri poliesteri per ancoraggio
1370	112	Nastri poliesteri fluorescenti per ancoraggio
1375	112	Nastri poliesteri per sollevamento
4570	112	Nastri poliesteri per sollevamento (tipo brache)
1346	113	Stamoid Edge Ferrari

15 TENDITELO ELASTICI

cod	pag	
1501	116	Tenditelo gancio cestello
1501	117	Tenditelo gancio cestello GC f.z.
1503	118	Tenditelo gancio sfera
1504	119	Tenditelo gancio con sicura
1504	119	Tenditelo serravele
1508	119	Tiranti
1505	120	Tenditelo gancio nero
1506	120	Tenditelo gancio nero
1507	120	Tenditelo gancio nylon
1510	121	Tenditelo pura gomma

18 ANELLI / MEZZANELLI

cod pag

1801	124	Anelli tondi saldati f.z.
1801	124	Anelli tondi saldati acciaio inox
1805	125	Anelli a pera f.z.
1810	125	Mezzanelli saldati f.z.
1810	125	Mezzanelli non saldati f.z.
1810	125	Mezzanelli acciaio inox
1812	125	Mezzanelli nylon
1813	125	Mezzanelli saldati f.z.
1813	126	Triangolo saldato f.z.
1815	126	Anelli ovali f.z.

25 CARRUCOLE GUIDE / ACCESSORI

cod pag

	130	Binari, carrelli, ruote Ø 15
2519	131	Binari
2521	131	Paracolpi
2521	131	Staffe
2501	132	Carrucole 1 cuscinetto
2502	132	Carrucole 2 cuscinetti
	134	Binari, carrelli, ruote Ø 24
2519	135	Binari
2520	135	Curve per binari
2521	135	Paracolpi
2521	135	Staffe
2521	136	Giunzioni per binari
2501	136	Carrucole 1 cuscinetto
2502	137	Carrucole 2 cuscinetti
2504	139	Carrucole 4 cuscinetti
2510	140	Contropiastre f.z. per carrucole
2510	140	Contropiastre nylon per carrucole
	142	Binari, carrelli, ruote Ø 38
2519	143	Binari
2521	143	Staffe
2502	144	Carrucole 2 cuscinetti
2504	145	Carrucole 4 cuscinetti
	146	Binari, carrelli, ruote Ø 38
2519	147	Binari
2502	148	Carrucole 2 cuscinetti
2504	148	Carrucole 4 cuscinetti
2550	149	Carrelli per tende da sole

30 NASTRINO / TUBETTO E PROFILI IN PVC

cod pag

	151	Nastrino apprettato
3001	152	Nastrino Dralon 100%
3008	152	Tubetto PVC per esterni
3201	152	Profilo PVC 656
3012	152	Profilo a spina per capottine
3013	153	Strappo rapido per tende da sole
3020	153	Tubetto PVC per interni
3025	153	Tubetto rigido PVC per interni
3030	154	Tondino PVC pieno

32 NASTRINO / TUBETTO E PROFILI IN PVC

cod pag

3201	156	Profili PVC
7848	158	Zip speciali
3201	159	Profili per antivento
3220	160	Guaina 1 aletta
3222	160	Guaina 2 alette aperte
3223	161	Guaina 2 alette saldate
3225	162	Guaina oscurante
0732	163	Ganci per guaina
3230	164	Profili alluminio
3230	166	Profili PVC
3201	167	Profili PVC per tende da campeggio
3235	167	Profili alluminio
3235	167	Raccordi f.z.
3235	168	Tappi nylon
3240	168	Manovelle pieghevoli
3240	169	Molle a rilascio costante
7845	170	Zip portoni industriali
3280	172	Profilo Poly
3280	172	Profilo x6 f.z.
3280	172	Compensatore
3280	173	Ovale f.z. con nastro nero

40 SISTEMI DI ANCORAGGIO E SOLLEVAMENTO

cod pag

		25 mm
4001	174	Sistemi di ancoraggio
4002	176	Cricchetti
4005	177	Ganci uncino
4005	177	Ganci a "S"
		35 mm
4001	178	Sistemi di ancoraggio
4001	179	Sistemi di ancoraggio gancio tendex
4003	179	Cricchetti
4005	179	Ganci uncino
4005	180	Ganci sponda
4001	180	Sistemi di ancoraggio gancio uncino
		50 mm
4001	181	Sistemi di ancoraggio gancio sponda
4001	181	Sistemi di ancoraggio gancio uncino
4001	182	Sistemi di ancoraggio gancio tendex
4001	182	Sistemi di ancoraggio asola rinforzata
4002	183	Protezione angolare
4003	183	Cricchetti
4003	184	Cricchetti con gancio applicato
4005	185	Ganci
		75 mm
4003	188	Cricchetti
4005	188	Ganci uncino
	189	Etichetta tipo - Sistemi di ancoraggio
1370	190	Nastri poliestere per ancoraggio
1370	192	Nastri poliestere fluorescenti per ancoraggio
1370	192	Nastri poliestere fluorescenti per sollevamento
4570	193	Brache - Cinghie piatte a nastro doppio per sollevamento
4570	193	Nastri poliestere per sollevamento (tipo brache)
	194	Linea Hobby

45 SISTEMI DI TENSIONAMENTO

cod pag

4501	196	Tenditore a 2 forcelle acciaio Inox
4505	196	Tenditori a 2 forcelle saldate acciaio Inox
4508	196	Tenditore a 2 occhi acciaio Inox
4509	197	Tenditori occhio e gancio acciaio Inox
4510	197	Tenditori a 2 ganci acciaio Inox
4512	197	Golfari maschi acciaio inox
4513	198	Golfari femmine acciaio inox
4521	198	Grilli diritti con chiave acciaio Inox
4522	198	Grilli a cuore acciaio Inox
4523	199	Grilli diritti acciaio Inox con perno a brugola
4531	199	Moschettoni con anello acciaio Inox
4550	199	Redance DIN 6899A acciaio FE 360 B
4552	200	Redance in acciaio Inox
4553	200	Ponticelli acciaio Inox
4554	200	Morsetti a cavallotto acciaio Inox
4544	201	Maniglie rapide acciaio inox
4566	201	Maniglie rapide triangolari acciaio inox
4555	201	Manicotti in rame e alluminio per pressature
4556	202	Cavallotti ad U acciaio Inox
4560	203	Cavi acciaio Inox AISI 316 e acciaio zincato
4562	203	Cavo antigiro 19x7 acciaio zincato
1145	204	Trecce speciali
4570	207	Cinghie piatte a nastro doppio per sollevamento
4570	207	Nastri poliestere per sollevamento tipo brache

50 PRONTOCAR

cod pag

5003	209	Prontocar acciaio Inox scatto
5003	211	Prontocar acciaio Inox molla
5003	212	Tenditore inox
5012	213	Piastre fissaggio Prontocar
0960	214	Collare e bulloni a strappo
1370	214	Nastri Prontocar
5015	215	Ganci - Prontocar
5015	216	Cinghie - Prontocar
5008	217	Nastri riflettenti Orafol® · Oralite® · VC 104 · 3M®
5010	217	Cinghie saldabile PVC
5010	218	Cavo antitaglio
5010	218	Cinghie saldabili PVC con asole
5020	219	Carrucole
5040	226	Barre tenditrici - perni
5045	228	Profili tensione telo
5045	228	Pistone barra retrattile
5020	229	Binari vari
5045	229	Canalina per guaina
5018	230	Guaine per binario
5018	232	Cuscinetti
5050	234	Piatti PVC tetto
5050	236	Piatti rinforzati
5060	236	Nastri per tetto
5019	237	Tenditori
5019	239	Chiave per tenditori
5019	241	Chiusura zincata

70 CRISTAL

cod pag

7003	244	Cristal PLUS
7003	245	Cristal TOP
7015	248	Cristal TOP finestrato
7015	248	Cristalplus goffrato
7004	249	Cristal PRIME
7030	252	Cristal in lastra
7007	252	Cristal Art Colorato trasparente
7008	252	Cristal PRINT
7050	253	Cristal port in strisce
7052	253	Cristal port in manti
7056	254	Profili e staffe f.z.
7056	254	Profili e staffe acciaio inox 430

75 RETI

cod pag

7501	257	Reti indemagliabili
7510	257	Reti ombreggianti frangivento
7520	257	Reti a rombi
7520	257	Zanzariera fibra vetro

78 CERNIERE / CHIUSURA A STRAPPO FILO PER CUCIRE

cod pag

7801	259	Tappi per piscina
7802	260	Valvola di gonfiaggio
7803	260	Articoli copri-piscina
7801	261	Tappi
7810	262	Stecche rigide PVC
7830	262	Chiusura a strappo adesiva
7834	263	Chiusura a strappo da cucire
7837	263	Chiusura a strappo da saldare
7830	264	Velcro One Wrap
7839	264	Disco PVC
7840	265	Cerniere divisibili spirali da cucire
7840S	266	Cerniere divisibili spirali da saldare
7842	267	Cerniere spirali su rotolo
7843	267	Cursori per spirali
7840P	268	Cerniere divisibili pressofuse da cucire
7841	268	Cerniere divisibili pressofuse da saldare
7842	269	Cerniere pressofuse su rotolo
7844	269	Cursori per pressofuse
7845	271	Dentini di ricambio
7848	272	Zip speciali
7849	274	Cerniere divisibili YKK® pressofuse
7849	276	Cursori YKK® per pressofuse
7849	277	Cerniere YKK® spirali
7849	277	Cursori YKK® per spirali
7842	278	Cerniere
7845	279	Zip per portoni industriali
7845	279	Zip Nyseal
7845	280	ZIP AIR
7845	280	Cerniera REFRESH

7850	281	Filo per cucire Rasant
7860	282	Filo per cucire Saba
7872	283	Filo per cucire Tenara
7870	284	Filo per cucire Serafil
7880	286	Filo per cucire OutdoorPro

80 PUNZONI / FUSTELLE

cod pag

8001	288	Punzoni a martello tondi
8002	288	Punzoni a martello rivetti
8002	289	Punzoni a martello tourniquet
8002	289	Punzoni a martello vari
8002	289	Punzoni a martello TIR ovali
8007	290	Punzoni a martello capicorda
8011	290	Fustelle a martello tonde
8012	291	Fustelle a martello varie
8017	292	Fustelle a martello multiple
8017	292	Fustelle a martello DOT
8017	293	Fustelle a martello varie
8031	293	Punzoni per torchio tondi
8032	293	Punzoni per torchio
8033	294	Punzoni per torchio
8037	294	Punzoni per torchio vari
8037	295	Punzoni per torchio bottoni
8041	295	Fustelle per torchio
8042	296	Fustelle per torchio a sfera
8049	296	Ricambi e accessori

85 ACCESSORI

cod pag

8501	298	Torchi
8501	298	Torchi per stampa digitale
8501	299	Torchi da utilizzare con fustella e punzone per torchio
8501	300	Autoperforanti
9001	300	Stampi
8503	301	Chiavi Clipmax
8505	301	Pinze
8505	302	Pinze
8507	302	Piastre PEHD
8510	302	Collanti
8509	303	Collanti
8511	303	Nastri vari
8511	304	Nastri per riparazioni
8511	304	Impermeabilizzanti per tessuti acrilici
8512	304	Impermeabilizzanti
8517	305	Prodotti per la pulizia
8565	306	Prodotti Leister®
8565	307	Rulli in gomma
8566	308	Uniplan 300
8566	308	Uniplan 500
8566	309	Tapemat
8566	310	Variant T1
8566	310	Hemtek ST
8568	314	Martelletto pneumatico

8569	314	Coltello elettrico per tessuti
8575	314	Lastre isolanti per saldatrici
8577	314	Isolanti Teflon adesivi
8577	315	Elettrodi
8583	315	Forbici
8583	315	Taglierino
8590	316	Chiodatrici
0550	316	Punti per chiodatrice
8590	317	Rivettatrici

90 OCCHIELLATRICI

cod pag

9001	319	Occhiellatrici autoperforanti
9001	319	Stampi
9001	320	Occhiellatrici autoperforanti
9001	321	Occhiellatrici autoperforanti
9001	322	Stampi
9001	323	Occhiellatrici automatiche autoperforanti
9001	324	Occhiellatrici automatiche autoperforanti





Soluzioni che fanno la differenza

In un mondo che corre veloce, la tempestività è il nostro punto di forza. Arteca ha raggiunto livelli di eccellenza progettando e realizzando accessori e componenti tecnici all'avanguardia. Con soluzioni smart e su misura, affrontiamo ogni sfida con passione e competenza.

———— A WORLD OF SOLUTION



Quarant'anni di innovazione e passione

Il nostro successo nasce dalle persone: creare un forte spirito di squadra e un senso di appartenenza ci spinge a dare sempre il massimo. Crediamo che con entusiasmo e dedizione si possano raggiungere traguardi straordinari.

Parte del gruppo Giovanardi, Arteca è il punto di riferimento mondiale per soluzioni nei settori trasporti, nautica, protezione solare, advertising e tempo libero. Siamo il partner ideale per costruire il futuro, insieme.



/
ZEROUNO

Occhielli
& Ranelle

01



Ottone



Nichel



Nichel satinato



Ottone antico



Canna di fucile



Nichel antico



Rame satinato



Rame antico



Argento antico



Rame nero



Acciaio inox



Aluzinco



Alluminio



Zinco Nichel



Nastro Dx54
Lega:
90% Alluminio · 10% Silicio

new

*Nuova
colorazione*

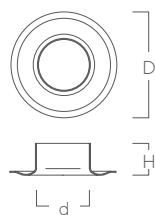

01.01 Occhielli rotondi alluminio

Serie VL

Codice	Prodotto	U.m.	Conf.	d	D	H
010108A	VL 31 mm 08	nr	1.000	8	15	6,5
010110A	VL 40 mm 10	nr	1.000	10	20	5,5
010112A	VL 50 mm 12	nr	1.000	12	22	6,5
010114A	VL 60 mm 14	nr	1.000	14	24	6,3
010116A	VL 70 mm 16	nr	1.000	16	30	7,1
010118A	VL 80 mm 18	nr	1.000	18	34	7,5
010125A	VL 100 mm 25	nr	1.000	25	49	10,5
010140A	VL 150 mm 40	nr	1.000	40	62	11,0

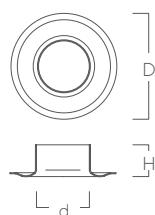

01.02 Occhielli rotondi ferro nichel

Serie VL

Codice	Prodotto	U.m.	Conf.	d	D	H
010208FN	VL 31 mm 08	nr	1.000	8	15	6,5
010210FN	VL 40 mm 10	nr	1.000	10	20	5,5
010212FN	VL 50 mm 12 per torchio manuale autoperf.	nr	1.000	12	22	6,5
010214FN	VL 60 mm 14	nr	1.000	14	24	6,3
010216FN	VL 70 mm 16	nr	1.000	16	30	7,1
010218FN	VL 80 mm 18	nr	1.000	18	34	7,5
01240FN	VL 150 mm 40	nr	1.000	40	62	11,0

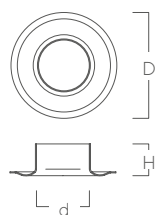

01.04 Occhielli rotondi zinco nichel ranelle per macchina

NEW Serie VL

Codice	Prodotto	U.m.	Conf.	d	D	H
010414FZN	VL 60 mm 14	nr	1.000	14	24	6,3
010416FZN	VL 70 mm 16	nr	1.000	16	30	7,1
010418FZN	VL 80 mm 18	nr	1.000	18	34	7,5





01.05 Occhielli rotondi ottone Serie VL

Codice	Prodotto	U.m.	Conf.	d	D	H
010508O	VL 31 mm 08	nr	1.000	8	15	6,5
010510O	VL 40 mm 10	nr	1.000	10	20	5,5
010512O	VL 50 mm 12	nr	1.000	12	22	6,5
010514O	VL 60 mm 14	nr	1.000	14	24	6,3
010516O	VL 70 mm 16	nr	1.000	16	30	7,1
010518O	VL 80 mm 18	nr	1.000	18	34	7,5
010525O	VL 100 mm 25	nr	1.000	25	49	10,0
010540O	VL 150 mm 40	nr	1.000	40	62	11,0



01.06 Occhielli rotondi ottone nichel Serie VL

Codice	Prodotto	U.m.	Conf.	d	D	H
010608ON	VL 31 mm 08	nr	1.000	8	15	6,5
010610ON	VL 40 mm 10	nr	1.000	10	20	5,5
010612ON	VL 50 mm 12	nr	1.000	12	22	6,5
010614ON	VL 60 mm 14	nr	1.000	14	24	6,3
010616ON	VL 70 mm 16	nr	1.000	16	30	7,1
010618ON	VL 80 mm 18	nr	1.000	18	34	7,5
010624ON	VL 100 mm 25	nr	1.000	25	49	10,0
010640ON	VL 150 mm 40	nr	1.000	40	62	11,0



01.08 Occhielli rotondi acciaio inox 304

Serie VL

Codice	Prodotto	U.m.	Conf.	d	D	H
010808AI	VL 31 mm 08*	nr	1.000	8	15	6,5
010810AI	VL 40 mm 10	nr	1.000	10	20	5,5
010812AI	VL 50 mm 12 *	nr	1.000	12	22	6,5
010814AI	VL 60 mm 14	nr	1.000	14	24	6,3
010816AI	VL 70 mm 16	nr	1.000	16	30	7,1
010818AI	VL 80 mm 18 *	nr	1.000	18	34	7,5
010824AI	VL 100 mm 25	nr	1.000	25	49	10,0
010840AI	VL 150 mm 40	nr	1.000	40	62	11,0

* Disponibili anche in acciaio **inox 316**



01.10 Occhielli rotondi aluzinco

Serie VL

Codice	Prodotto	U.m.	Conf.	d	D	H
011016AZF	VL 70 mm 16 ranelle piatta	nr	1.000	16	30	7,1
011018AZF	VL 80 mm 18 ranelle piatta	nr	1.000	18	34	7,5
011040AZF	VL 150 mm 41 ranelle piatta	nr	1.000	41	62	11,0



01.10 Occhielli rotondi aluzinco ranelle per macchina

Serie VL

Codice	Prodotto	U.m.	Conf.	d	D	H
011012AZF	VL 50 mm 12 ranelle colletto	nr	1.000	12	22	6,5
011014AZF	VL 60 mm 14 ranelle colletto	nr	1.000	14	24	6,3
011016AZF	VL 70 mm 16 ranelle colletto	nr	1.000	16	30	7,1
011018AZF	VL 80 mm 18 ranelle colletto	nr	1.000	18	34	7,5





01.11 Occhielli rotondi alluminio ranello per macchina Serie VL

Codice	Prodotto	U.m.	Conf.	d	D	H
011114ASF	VL 60 mm 14 ranello colletto	nr	1.000	14	24	6,3
011116ASF	VL 70 mm 16 ranello colletto	nr	1.000	16	30	7,1
011118ASF	VL 80 mm 18 ranello colletto	nr	1.000	18	34	7,5



01.16 Occhielli rotondi ottone nichel ranello per macchina Serie VL

Codice	Prodotto	U.m.	Conf.	d	D	H
011610ONSF	VL 40 mm 10 ranello colletto	nr	1.000	10	20	5,5
011612ONSF	VL 50 mm 12 ranello colletto	nr	1.000	12	22	6,5
011614ONSF	VL 60 mm 14 ranello colletto	nr	1.000	14	24	6,3
011616ONSF	VL 70 mm 16 ranello colletto	nr	1.000	16	30	7,1
011618ONSF	VL 80 mm 18 ranello colletto	nr	1.000	18	34	7,5



01.10 Occhielli rotondi aluzinco Serie E (DIN)

Codice	Prodotto	U.m.	Conf.	d	D	H
011010AZ	mm 10	nr	1.000	10	20	6,0
011012AZ	mm 12	nr	1.000	12	24	7,8
011012AZC	mm 12 ranello colletto	nr	1.000	12	24	7,8
011014AZ	mm 14	nr	1.000	14	27	8,4



01.10 Occhielli rotondi aluzinco Serie E (DIN)

Codice	Prodotto	U.m.	Conf.	d	D	H
011016AZ	mm 16 ranelle con bugne	nr	1.000	16	30	8,8
011016AZC	mm 16 ranelle collette	nr	1.000	16	30	8,8
011018AZ	mm 18 ranelle con bugne	nr	1.000	18	34	7,5
011020AZ	mm 20 ranelle con bugne	nr	1.000	20	36	9,4
011025AZ	mm 25 ranelle con bugne	nr	1.000	25	44	11,3
011036AZ	mm 36 ranelle con bugne	nr	1.000	36	60	11
011040AZ	mm 38 ranelle con bugne	nr	1.000	38	62	13,0



01.05 Occhielli rotondi ottone Serie E (DIN)

Codice	Prodotto	U.m.	Conf.	d	D	H
010510OE	mm 10	nr	1.000	10	20	6,0
010512OE	mm 12 *	nr	1.000	12	24	7,8
010514OE	mm 14	nr	1.000	14	27	8,4

* A richiesta ranelle a colletto



01.05 Occhielli rotondi ottone Serie E (DIN)

Codice	Prodotto	U.m.	Conf.	d	D	H
010516OE	mm 16 ranelle con bugne *	nr	1.000	16	30	8,8
010518OE	mm 18 ranelle con bugne	nr	1.000	18	34	7,5
010520OE	mm 20 ranelle con bugne	nr	1.000	20	36	9,4
010525OE	mm 25 ranelle con bugne *	nr	1.000	25	44	11,3
010540OE	mm 38 ranelle con bugne	nr	1.000	38	62	13,0

* A richiesta ranelle a colletto



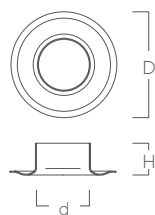

01.06 Occhielli rotondi ottone nichel Serie E (DIN)

Codice	Prodotto	U.m.	Conf.	d	D	H
010610ONE	mm 10	nr	1.000	10	20	6,0
010612ONE	mm 12 *	nr	1.000	12	24	7,8
010614ONE	mm 14	nr	1.000	14	27	8,4

* A richiesta ranello a colletto



01.06 Occhielli rotondi ottone nichel Serie E (DIN)

Codice	Prodotto	U.m.	Conf.	d	D	H
010616ONE	mm 16 ranello con bugne *	nr	1.000	16	30	8,8
010618ONE	mm 18 ranello con bugne	nr	1.000	18	34	7,5
010620ONE	mm 20 ranello con bugne	nr	1.000	20	36	9,4
010625ONE	mm 25 ranello con bugne	nr	1.000	25	44	11,3
010640ONE	mm 38 ranello con bugne	nr	1.000	38	62	13,0

* A richiesta ranello a colletto



01.08 Occhielli rotondi acciaio inox Serie E (DIN)

Codice	Prodotto	U.m.	Conf.	d	D	H
010810AIE	mm 10	nr	1.000	10	20	6,0
010810AIEC	mm 10 ranello colletto	nr	1.000	10	20	6,0
010812AIE	mm 12	nr	1.000	12	24	7,8
010814AIE	mm 14	nr	1.000	14	27	8,4

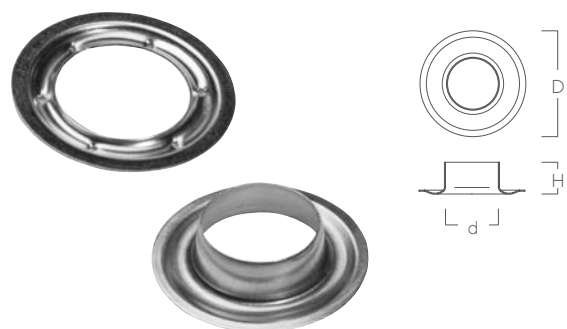

01.08 Occhielli rotondi acciaio inox Serie E (DIN)

Codice	Prodotto	U.m.	Conf.	d	D	H
010816AIE	mm 16 ranelle con bugne	nr	1.000	16	30	8,8
010818AIE	mm 18 ranelle con bugne	nr	1.000	18	34	7,5
010820AIE	mm 20 ranelle con bugne	nr	1.000	20	36	9,4
010825AIE	mm 25 ranelle con bugne	nr	1.000	25	44	11,3
010840AIE	mm 38 ranelle con bugne	nr	1.000	38	62	13,0



01.6 Occhielli rotondi Serie BA e OB

Codice	Prodotto	U.m.	Conf.	d	D	H
01623BO	23B/AR ottone	nr	1.000	9	16	6,5
01623BON	23B/AR ottone nichel	nr	1.000	9	16	6,5
01624BO	24B/AR ottone	nr	1.000	10	17,5	6
01624BON	24B/AR ottone nichel	nr	1.000	10	17,5	6
01625BO	25B/AR-VA ottone	nr	1.000	10,5	20	7,5
01625BON	25B/AR-VA ottone nichel	nr	1.000	10,5	20	8,5
01628BO	28B/AR-VA ottone	nr	1.000	13	24	9
01628BON	28B/AR-VA ottone nichel	nr	1.000	13	24	9
01628BAI	28B/AR-VA acciaio inox	nr	1.000	13	24	9
01629BO	29B/AR ottone	nr	1.000	14,5	25,5	10
01629BON	29B/AR ottone nichel	nr	1.000	14,5	25,5	10
01630BO	30B/AR-VA ottone	nr	1.000	16,5	28	10
01630BON	30B/AR-VA ottone nichel	nr	1.000	16,5	28	10
01630BAI	30B/AR-VA acciaio inox	nr	1.000	16,5	28	10
01631BO	31B/AR-VA ottone	nr	1.000	19,5	31,7	10
01631BON	31B/AR-VA ottone nichel	nr	1.000	19,5	31,7	10





01.6 Occhielli rotondi Serie BA e OB

Codice	Prodotto	U.m.	Conf.	d	D	H
016OB50	OB50 ottone	nr	1.000	11,2	21	6,5
016OB50ON	OB50 ottone nichel	nr	1.000	11,2	21	6,5
016OB60	OB60 ottone	nr	1.000	13	24,5	8
016OB60ON	OB60 ottone nichel	nr	1.000	13	24,5	8
016OB70	OB70 ottone	nr	1.000	15	28,5	7,4
016OB70ON	OB70 ottone nichel	nr	1.000	15	28,5	7,4



01.20 Occhielli ovali

Codice	Prodotto	U.m.	Conf.	lxm	LxM	H
012027AZ	aluzinco	nr	1.000	27x8	40x20	10
012040AZ	aluzinco ranelle con bugne	nr	1.000	40x10	55x15	8
012040O	ottone ranelle con bugne	nr	1.000	40x10	55x15	8
012040ON	ottone nichel ranelle con bugne	nr	1.000	40x10	55x15	8



01.20 Occhielli ovali

Codice	Prodotto	U.m.	Conf.	lxm	LxM	H
012042A	alluminio	nr	1.000	40x20	61x41	11
012042AZF	aluzinco	nr	1.000	40x20	61x41	11
012042O	ottone	nr	1.000	40x20	61x41	11
012042ON	ottone nichel	nr	1.000	40x20	61x41	11
012042AI	acciaio inox	nr	1.000	40x20	61x41	11

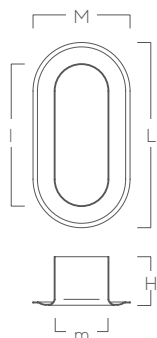

01.20 Occhielli ovali Serie E (DIN)

Codice	Prodotto	U.m.	Conf.	lxm	LxM	H
012042AZE	aluzinco ranelle con bugne	nr	1.000	42x22	60x40	11
012042OE	ottone ranelle con bugne	nr	1.000	42x22	60x40	11
012042ONE	ottone nichel ranelle con bugne	nr	1.000	42x22	60x40	11
012042AIE	acciaio inox ranelle con bugne	nr	1.000	42x22	60x40	11

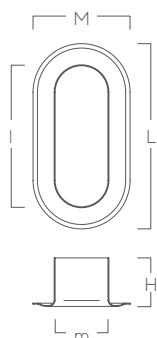

01.20 Occhielli ovali

Codice	Prodotto	U.m.	Conf.	lxm	LxM	H
012042ZY	zytel	nr	1.000	40x21	60x40	8,0

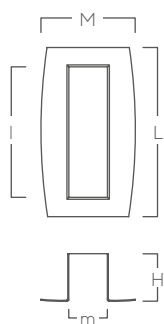

01.50 Occhielli rettangolari

Codice	Prodotto	U.m.	Conf.	lxm	LxM	H
015027FZ	mm 27x8 f.z.	nr	100	27x8	35x20	9,8
015027FM	mm 27x8 verniciato verde militare	nr	100	27x8	35x20	9,8
015027O	mm 27x8 ottone*	nr	100	27x8	35x20	9,8
015038FZ	mm 38x8 alluminato	nr	100	38x8	53x20	9,8
015038O	mm 38x8 ottone*	nr	100	38x8	53x20	9,8

*a richiesta ottone nichelato





01.70 Occhielli per stampa digitale

Codice	Prodotto	U.m.	Conf.
0170080ON	# 1 mm 8,0 ottone nichel	nr	500
0170094ON	# 2 mm 9,4 ottone nichel	nr	500
0170116ON	# 3 mm 11,6 ottone nichel	nr	500
0170145ON	# 4 mm 14,5 ottone nichel	nr	500
0170182ON	# 5,5 mm 18,2 ottone nichel	nr	500

Disponibili punzoni per torchio - Art. 80.33
 Applicabili con torchio per stampa digitale 85019201/203

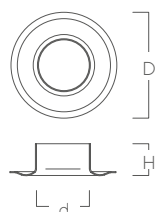

01.70 Occhielli per stampa digitale

Codice	Prodotto	U.m.	Conf.	D	d	H
0170208P	mm 8 PVC trasparente solo occhio	nr	1.000	15	8	8
0170210P	mm 10 PVC trasparente occhio + ranella	nr	1.000	18	10	9
0170212P	mm 12 PVC trasparente occhio + ranella	nr	1.000	24	12	9
0170216P	mm 16 PVC trasparente occhio + ranella	nr	1.000	28	16	12

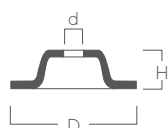

01.80 Ranella concava

Codice	Prodotto	U.m.	Conf.	D	d	H
018000T	Per tetti	nr	100	24	5	6,6



B22 Occhielli PVC montaggio rapido

NEW

Codice	Prodotto	U.m.	Conf.
B2214000	foro 12mm col.BLU	nr	blister da 12pz
B2216000	foro 12mm col.BIANCO	nr	blister da 12pz
B2217000	foro 12mm col.NERO	nr	blister da 12pz



/
ZEROTRE

Cavallotti
& Contropiastre

03

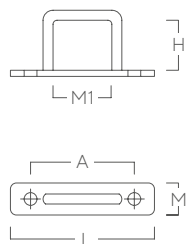

03.01 Cavallotti export 2 fori f.z.

Codice	Prodotto	U.m.	Conf.	A	L	M	H	M1
03010130	exp 2 fori H.30	nr	200	56	72	16	30	25

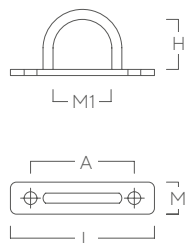

03.01 Cavallotti export 2 fori tondo f.z.

Codice	Prodotto	U.m.	Conf.	A	L	M	H	M1
03010225	exp 2 fori H.25	nr	200	56	72	16	25	25
03010230	exp 2 fori H.30	nr	200	56	72	16	30	25

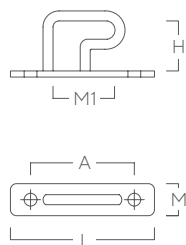

03.01 Cavallotti export 2 fori pipa f.z.

Codice	Prodotto	U.M.	Conf.	A	L	M	H	M1
03010330	exp 2 fori H.30 pipa	nr	200	56	72	16	30	29

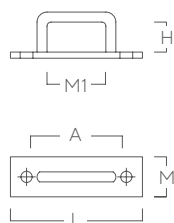

03.02 Cavallotti standard f.z.

Codice	Prodotto	U.M.	Conf.	A	L	M	H	M1
03020115	standard H.15	nr	200	51	66	20	15	25
03020120	standard H.20	nr	200	51	66	20	20	25
03020127	standard H.27	nr	200	51	66	20	27	25

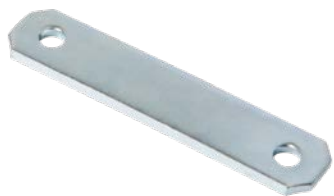

03.01 Contropiastre

Codice	Prodotto	U.M.	Conf.	A	L	M
03010199	export f.z.	nr	200	56	72	16

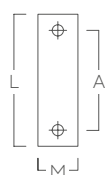

03.02 Contropiastre

Codice	Prodotto	U.M.	Conf.	A	L	M
03029900	standard f.z.	nr	200	51	66	20



03.02 Contropiastre

Codice	Prodotto	U.M.	Conf.	A	L
030299NY	nylon bianca riv. inc. 4,5x9,2o.n. (09050459)	nr	200	51	67
030299NYL	nylon bianca riv. inc. 4,5 x 10,5 o.n. (09051512)	nr	200	51	67
030299NYN	nylon nera riv. inc. 4,5x9,2o.n. (09050459)	nr	200	51	67
030299NYNL	nylon nera riv. inc. 4,5 x 10,5 o.n. (09051512)	nr	200	51	67

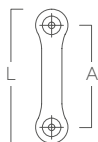

03.02 Contropiastre

Codice	Prodotto	U.M.	Conf.	A	L
030295NY	nylon bianca senza rivetto	nr	200	51	67
030295NYN	nylon nera senza rivetto	nr	200	51	67



03.02 Contropiastre

Codice	Prodotto	U.M.	Conf.	A	L	M
03029901	f.z. per cavallotti 03.03	nr	200	51	67	15

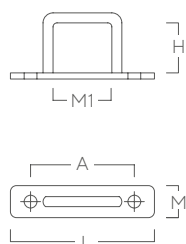

**03.03** Cavallotti 2 fori f.z.

Codice	Prodotto	U.m.	Conf.	A	L	M	H	M1
03030116	2 fori H.16	nr	200	51	66	15	16	26
03030120	2 fori H.20	nr	200	51	66	15	20	26
03030125	2 fori H.25	nr	200	51	66	15	25	26
03030130	2 fori H.30	nr	200	51	66	15	30	26
03030135	2 fori H.35	nr	200	51	66	15	35	26

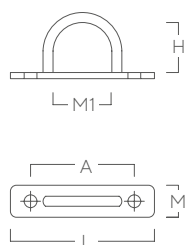
**03.03** Cavallotti 2 fori tondo f.z.

Codice	Prodotto	U.m.	Conf.	A	L	M	H	M1
03030221	2 fori H.21	nr	200	51	71	20	21	21
03030225	2 fori H.25	nr	200	51	71	20	25	21
03030230	2 fori H.30	nr	200	51	71	20	30	21
03030238	2 fori H.38	nr	200	51	71	20	38	21
03030245	2 fori H.45	nr	200	51	71	20	45	21
03030255	2 fori H.55	nr	200	51	71	20	55	21

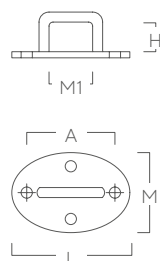
**03.04** Cavallotti 4 fori f.z.

Codice	Prodotto	U.M.	Conf.	A	L	M	H	M1
03040115	4 fori H.15	nr	200	45	59	40	15	23
03040120	4 fori H.20	nr	200	45	59	40	20	23
03040128	4 fori H.28	nr	200	45	59	40	28	23

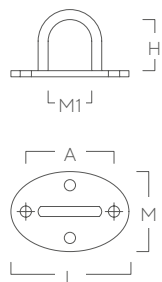

03.04 Cavallotti e contropiastre f.z.

Codice	Prodotto	U.m.	Conf.	A	L	M	H	M1
03040232	4 fori tondo H.32	nr	200	45	59	40	32	23

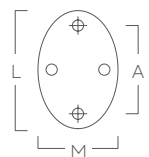

Codice	Prodotto	U.m.	Conf.	A	L	M
03040199	4 fori f.z.	nr	200	45	59	40

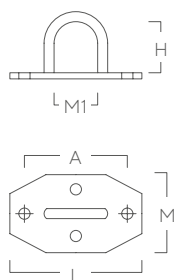

03.04 Cavallotti 4 fori f.z.

Codice	Prodotto	U.M.	Conf.	A	L	M	H	M1
03040326	4 fori H.26	nr	200	51	65	40	26	20
03040330	4 fori H.30	nr	200	51	65	40	30	20
03040338	4 fori H.38	nr	200	51	65	40	38	20
03040345	4 fori H.45	nr	200	51	65	40	45	20
03040355	4 fori H.55	nr	200	51	65	40	55	20



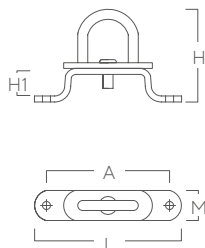

03.05 Cavallotti a molla con boccola sicurezza

Codice	Prodotto	U.m.	Conf.	A	L	M	H	H1
03050120	f.z.	nr	100	51	66	15	51	15
03050122	acciaio inox	nr	100	51	66	15	51	15

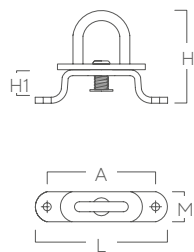

03.05 Cavallotti a molla

Codice	Prodotto	U.m.	Conf.	A	L	M	H	H1
03050121	f.z.	nr	100	51	66	15	52	15

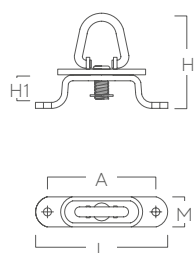

03.05 Cavallotti a molla snodati

Codice	Prodotto	U.M.	Conf.	A	L	M	H	H1
03050220	snodato f.z.	nr	100	51	66	15	59	15



03.05 Cavallotti a molla in nylon

Codice	Prodotto	U.M.	Conf.	A	L	M	H
030502NY	nylon grigio	nr	100	51	70	34	13
030503NY	nylon bianco	nr	100	51	70	34	13
030504NY	nylon avorio Ral 1015	nr	100	51	70	34	13
030505NY	nylon nero	nr	100	51	70	34	13
030506NY	nylon marrone Ral 8011	nr	100	51	70	34	13
030507NY	nylon beige Ral 1013	nr	100	51	70	34	13

Utilizzabili con Occhiello TIR ovale mm 40x20 - mm 42x22
Piastrina 030299NY - 030295NY

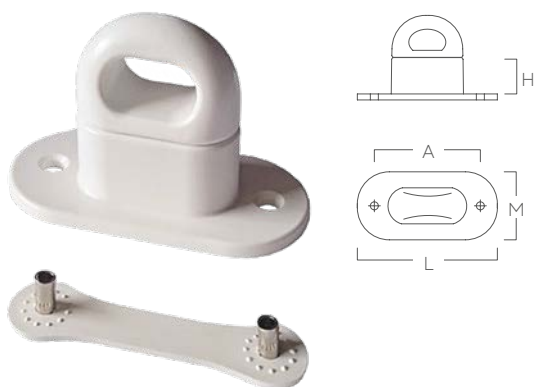

03.05 Cavallotti a molla in nylon doppia altezza

Codice	Prodotto	U.M.	Conf.	A	L	M	H
030512NY	nylon grigio	nr	100	51	70	34	15,5
030513NY	nylon bianco	nr	100	51	70	34	15,5
030514NY	nylon avorio Ral 1015	nr	100	51	70	34	15,5
030515NY	nylon nero	nr	100	51	70	34	15,5
030516NY	nylon marrone Ral 8011	nr	100	51	70	34	15,5
030517NY	nylon beige Ral 1013	nr	100	51	70	34	15,5

Utilizzabili con Occhiello TIR ovale mm 40x20 - mm 42x22
Piastrina 030299NY - 030295NY - 030299NYL



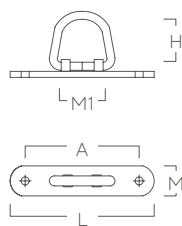

03.06 Cavallotti snodati saldati f.z.

Codice	Prodotto	U.m.	Conf.	A	L	M	H	M1
03062025	H.25	nr	100	51	72	22	25	20
03062037	H.37	nr	100	51	72	22	37	20
03062045	H.45	nr	100	51	72	22	45	20
03062055	H.55	nr	100	51	72	22	55	20

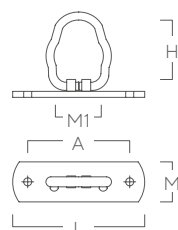

03.06 Cavallotti snodati saldati f.z.

Codice	Prodotto	U.m.	Conf.	A	L	M	H	M1
03062346	sagomato	nr	100	51	66	20	46	23



03.07 Anelli a pera f.z.

Codice	Prodotto	U.M.	Conf.	H	M1
03072329	29x23	nr	250	29	23



03.07 Anelli a pera f.z.

Codice	Prodotto	U.M.	Conf.	H	M1
03072343	43x23	nr	250	43	23

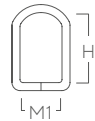

03.07 Anelli a pera sagomati f.z.

Codice	Prodotto	U.m.	Conf.	H	M1
03072346	sagomato	nr	250	46	23

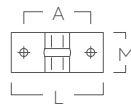

03.07 Piastre per anelli a pera

Codice	Prodotto	U.m.	Conf.	A	L	M
03079099	piastra per anello a pera	nr	250	30	46	20

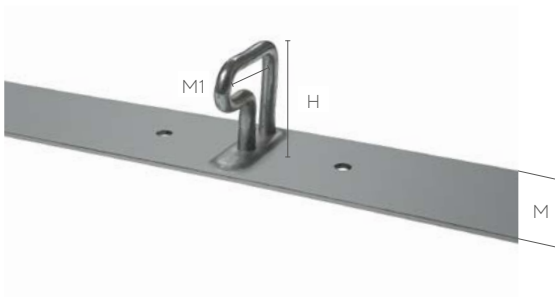

03.10 Bandelle TIR f.z.

Codice	Prodotto	U.M.	Conf.	L	M	H	M1
0310250P	ml 2,50 pipa	nr	10	2500	45	33	29
0310290P	ml 2,90 pipa	nr	10	2900	45	33	29

Ø fori 4,7 mm · Distanza tra cavallotti 200 mm

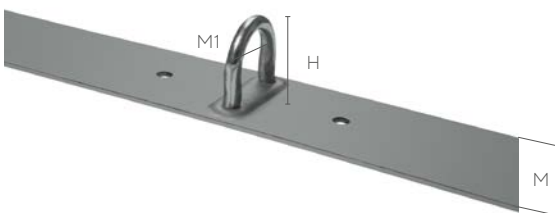

03.10 Bandelle TIR f.z.

Codice	Prodotto	U.M.	Conf.	L	M	H	M1
0310250T	ml 2,50 tonde	nr	10	2500	45	30	20
0310290T	ml 2,90 tonde	nr	10	2900	45	30	20

Ø fori 4,7 mm · Distanza tra cavallotti 200 mm



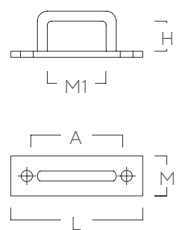

03.15 Cavallotti Jeep campagnola f.z.

Codice	Prodotto	U.m.	Conf.	A	L	M	H	M1
03150109	campagnola H.11	nr	100	41	50	12	11	22
03159900	contropiastra	nr	100	41	50	12		

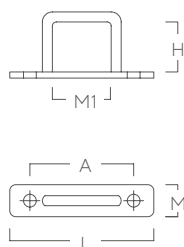

03.15 Cavallotti Jeep

Codice	Prodotto	U.m.	Conf.	A	L	M	H	M1
03150111	H.11 f.z.	nr	100	34	50	15	11	16
03150111M	H.11 verniciato verde militare (a richiesta)	nr	100	34	50	15	11	16
03150115	H.15 f.z.	nr	100	34	50	15	15	16
03150117	H.17 f.z.	nr	100	34	50	15	17	16



Codice	Prodotto	U.M.	Conf.	A	L	M
03159901	contropiastra jeep f.z.	nr	100	34	50	15

a richiesta **Acciaio Inox**



Codice	Prodotto	U.M.	Conf.	A	L	M
05060306	contropiastra nylon senza rivetto	nr	100	34	50	15



Codice	Prodotto	U.M.	Conf.	A	L	M
05060307	contropiastra nylon rivetto inc. (09050459)	nr	100	34	50	15



/
ZEROCINQUE

Chiusure

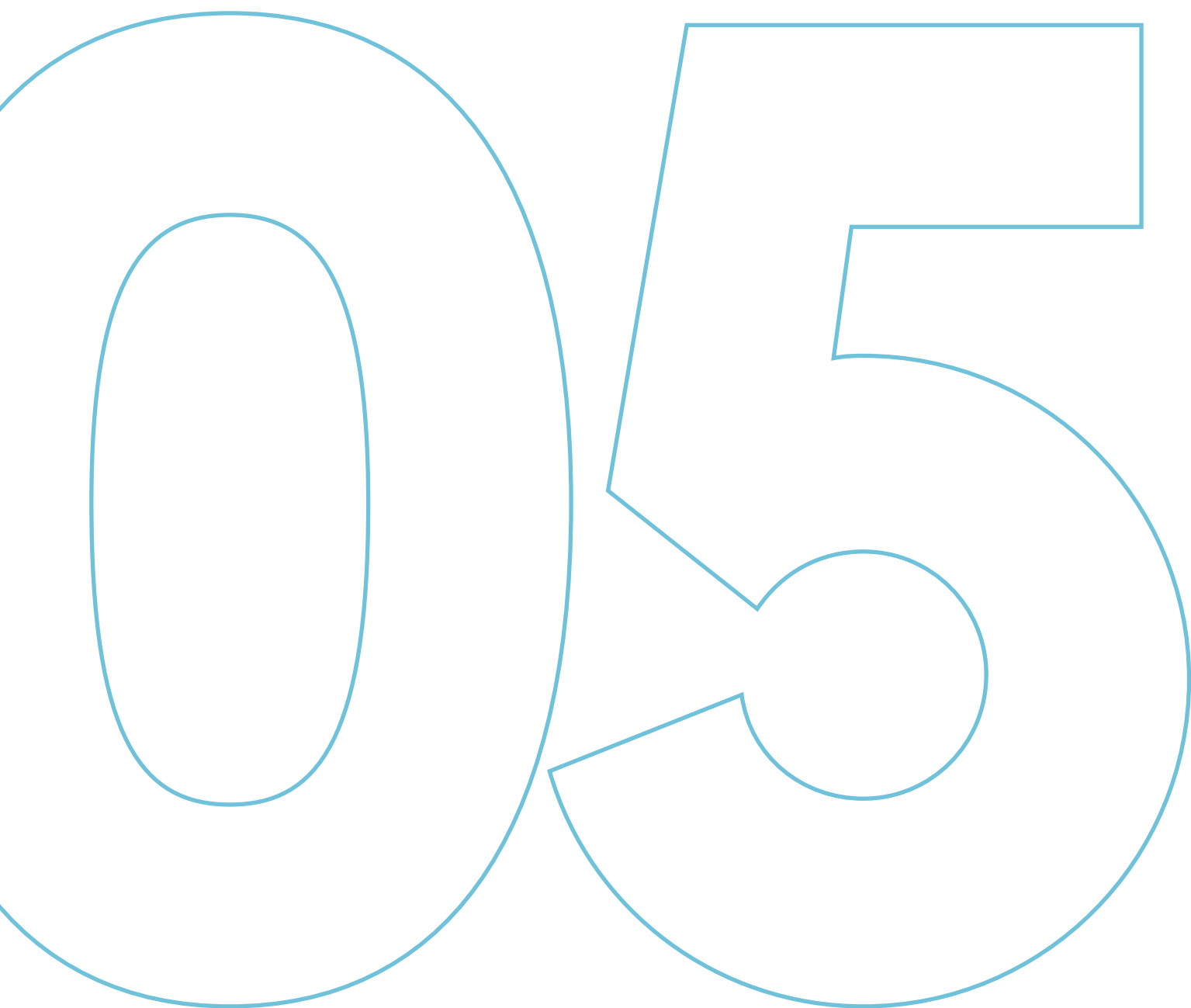



05.01 Loxx® parti superiori

Codice	Prodotto	U.m.	Conf.	D
050101AC	testa piccola mm 11 ottone cromato	nr	50	11
050101ON	testa piccola mm 11 ottone nichel	nr	50	11
050101OC	testa piccola mm 11 ottone cromato nero	nr	50	11
050101OA	testa piccola mm 11 ottone anticato	nr	50	11
050101OR	testa piccola mm 11 ottone rame antico	nr	50	11



Codice	Prodotto	U.m.	Conf.	D
050102AC	testa grossa mm 15 ottone cromato	nr	50	15
050102ON	testa grossa mm 15 ottone nichel	nr	50	15
050102OC	testa grossa mm 15 ottone cromato nero	nr	50	15
050102OA	testa grossa mm 15 ottone anticato	nr	50	15
050102OR	testa grossa mm 15 ottone rame antico	nr	50	15
050102AI	testa grossa mm 15 acciaio inox	nr	50	15



Codice	Prodotto	U.m.	Conf.	D
050117ON	testa liscia con anello ottone nichel	nr	50	



05.01 Loxx® viti autofilettanti 9 mm
Per metallo, legno e plastica

Codice	Prodotto	U.m.	Conf.	L
050107ON	mm 16 ottone nichel	nr	50	16
050107AI	mm 16 acciaio inox	nr	50	16
050108ON	mm 10 ottone nichel	nr	50	10
050108AI	mm 10 acciaio inox	nr	50	10
050109ON	mm 12 ottone nichel	nr	50	12
050107AC	mm 16 cromato	nr	50	16
050108AC	mm 10 cromato	nr	50	10
050109AC	mm 12 cromato	nr	50	12
050107OC	mm 16 cromato nero	nr	50	16
050108OC	mm 10 cromato nero	nr	50	10
050109OC	mm 12 cromato nero	nr	50	12



05.01 Loxx® viti autofilettanti 9 mm

Codice	Prodotto	U.M.	Conf.	L
050104AC	M5 x 10 mm cromato	nr	50	10
050104ON	M5 x 10 mm ottone nichel con bullone	nr	50	10
050104OC	M5 x 10 mm cromato nero	nr	50	10

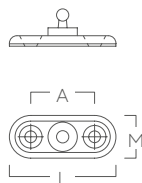

05.01 Loxx® biforo

Codice	Prodotto	U.M.	Conf.	L	M	H
050105AC	biforo ottone cromato	nr	50	15,1	11	27
050105ON	biforo ottone nichel	nr	50	15,1	11	27
050105OC	biforo ottone cromato nero	nr	50	15,1	11	27





05.01 Loxx® parti inferiori

Codice	Prodotto	U.m.	Conf.
050106AC	per tessuto ottone cromato	nr	50
050106ON	per tessuto ottone nichel	nr	50
050106OC	per tessuto ottone cromato nero	nr	50
050106OA	per tessuto ottone anticato	nr	50
050106OR	per tessuto ottone rame antico	nr	50



05.01 Loxx® parti inferiori

Codice	Prodotto	U.m.	Conf.
050112AI	piatto acciaio inox fissaggio a vite	nr	50
050113AI	piatto acciaio inox fissaggio con colla	nr	50



85.03 Loxx® chiavi

Codice	Prodotto	U.m.	Conf.
85030501R	chiave per avvitare con manico	nr	1
85030502	chiave per avvitare	nr	1



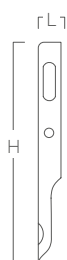

05.02 Capicorda

Codice	Prodotto	U.m.	Conf.	L	H
05020601	capocorda f.z. Ø 6	nr	100	6	58
05020602	occhiello ovale per capocorda Ø 6	nr	100		
05020603	chiodo f.z. capocorda Ø 6-8	nr	100		18
05020801	capocorda f.z. Ø 8	nr	100	8	70
05020802	occhiello ovale per capocorda Ø 8	nr	100		

80.07 Punzoni a martello capicorda



Codice	Prodotto	U.m.	Conf.
80070681	freccia	nr	1



Codice	Prodotto	U.m.	Conf.
80070682	porta freccia Ø 6	nr	1
80070686	porta freccia Ø 8	nr	1



Codice	Prodotto	U.m.	Conf.
80070683	punzone Ø 6-8	nr	1



Codice	Prodotto	U.m.	Conf.
80070684	base Ø 6	nr	1
80070685	base Ø 8	nr	1





05.03 Chiusure Jeep

Codice	Prodotto	U.m.	Conf.	L	M
012027AZ	occhiello ovale mm 27x8 aluzinco	nr	100	27	8

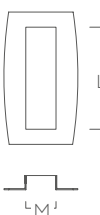

Codice	Prodotto	U.m.	Conf.	L	M
015027FZ	occhiello rettangolare mm 27x8 f.z.	nr	100	27	8
015027FM	occhiello rettangolare mm 27x8 verniciato verde militare (a richiesta)	nr	100	27	8
015027O	occhiello rettangolare mm 27x8 ottone	nr	100	27	8

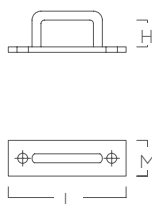

Codice	Prodotto	U.m.	Conf.	L	M
03150111	cavallotto h.11	nr	100	50	11
03150111M	cavallotto h.11 verniciato verde militare (a richiesta)	nr	100	50	11
03150115	cavallotto h.15	nr	100	50	15
03150117	cavallotto h.17	nr	100	50	17



Codice	Prodotto	U.m.	Conf.	L	M
03159901	contropiastra f.z.	nr	100	50	34



Codice	Prodotto	U.m.	Conf.	L	M
05060306	contropiastra nylon senza rivetto	nr	100	50	34

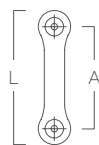

Codice	Prodotto	U.m.	Conf.	L	A	M
05060307	contropiastra nylon rivetto inc. (09050459)	nr	100	50	34	15



Codice	Prodotto	U.m.	Conf.	L	M
05030201	cinturino pvc telato cm 12 per occhiello jeep mm 27 x 8	nr	100	120	16

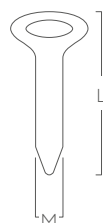

Codice	Prodotto	U.m.	Conf.	L	M
05030202	mm 42 x 22 grigio	nr	100	120	26
05030203	mm 42 x 22 bianco	nr	100	120	26
05030204	mm 42 x 22 beige	nr	100	120	26

Per occhiello mm 40 x 20



Codice	Prodotto	U.m.	Conf.	L	H
80022708	punzone a martello occhiello rettangolare	nr	1	27	8



Codice	Prodotto	U.m.	Conf.	L	H
80122708	fustella a martello occhiello rettangolare	nr	1	27	8





05.04 Clipmax parti superiori

Codice	Prodotto	U.m.	Conf.	D	H
05040101	parte superiore nylon bianca	nr	100	23	11

Altri colori a richiesta produzione minima 2000 pz.



05.04 Clipmax parti inferiori bullone

Codice	Prodotto	U.m.	Conf.	D	L	H
05040208	mm 08 o.n.	nr	100	6	8	20
05040212	mm 12 o.n.	nr	100	6	12	24
05040220	mm 20 o.n.	nr	100	6	20	32



05.04 Clipmax autofilettanti

Codice	Prodotto	U.m.	Conf.	D	H
05040401	testa a stella a.i.	nr	100	7	25



05.04 Clipmax parti inferiori

Codice	Prodotto	U.m.	Conf.	D	H
05040501	per tessuti vari nylon bianca	nr	100	23	20

Altri colori a richiesta produzione minima 2000 pz.



85.03 Clipmax chiavi

Codice	Prodotto	U.m.	Conf.
85030504	chiave per avvitare	nr	1



A

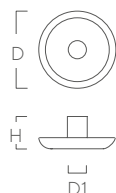

B

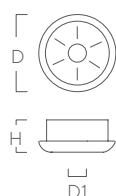

C

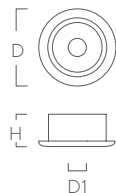

D

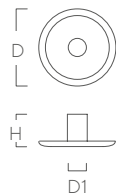

05.05 Bottoni

Codice	Prodotto	U.m.	Conf.	D	H	D1
05050115	testa Ø15 ottone nichel	A	nr 1.000	15	5	4
05050117	testa Ø17 ottone nichel	A	nr 1.000	17	5	4
05051115	testa Ø15 acciaio inox 304	A	nr 1.000	15	5	4
05051117	testa Ø17 acciaio inox 304	A	nr 1.000	17	5	4

Codice	Prodotto	U.m.	Conf.	D	H	D1
05050301	molla ottone nichel	B	nr 1.000	14	4,3	4,2
05051301	molla acciaio inox 304	B	nr 1.000	14	4,3	4,2

Codice	Prodotto	U.m.	Conf.	D	H	D1
05050201	godronato ottone nichel	C	nr 1.000	14,25	4,2	4,2
05051201	godronato acciaio inox 304	C	nr 1.000	14,25	4,2	4,2

Codice	Prodotto	U.m.	Conf.	D	H	D1
05050401	olgo ottone nichel	D	nr 1.000	14	6,7	4
05051401	olgo acciaio inox 304	D	nr 1.000	14	6,7	4

85.05 Pinze

Codice	Prodotto	U.m.	Conf.
85050508	per bottoni senza ricambi	nr	1

Abbinare punzoni per torchio bottoni 80.37

Codice	Prodotto	U.m.	Conf.
85050511	per occhielli e bottoni senza ricambi	nr	1

Per **occhielli tondi** abbinare punzoni 80.31 (max mm18)

Per **bottoni** abbinare punzoni 80.37



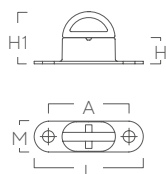

05.06 Turniquet Europeo

A richiesta contropiastre colore nero · Turniquet e occhielli zincato nero

Codice	Prodotto	U.m.	Conf.	A	L	M	H	H1
05060201	chiusura ottone	nr	100	34	46	13	11	22
05060301	chiusura ottone nichel	nr	100	34	46	13	11	22
05060601	chiusura acciaio inox	nr	100	34	46	13	11	22



Codice	Prodotto	U.m.	Conf.	A	L	H	M	H1
05060202	occhiello ovale ottone completo	nr	100		22,5	9	13,5	
05060302	occhiello ovale o.n. completo	nr	100		22,5	9	13,5	
05060602	occhiello ovale acciaio inox completo	nr	100		22,5	9	13,5	

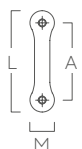

Codice	Prodotto	U.m.	Conf.	A	L	M
05060306	contropiastra nylon senza rivetto	nr	100	34	50	15
05060307	contropiastra nylon rivetto inc. (09050459)	nr	100	34	50	15



Codice	Prodotto	U.m.	Conf.	L	M
80022213	punzone a martello turniquet	nr	1	22,5	13,5
80122213	fustella a martello turniquet	nr	1	22,5	13,5
80372213	punzone per torchio turniquet	nr	1	22	13

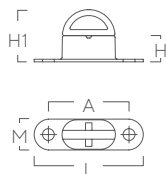

05.06 Turniquet

Europeo

A richiesta zincato nero

Codice	Prodotto	U.m.	Conf.	A	L	M	H	H1
05060701	chiusura ottone	nr	100	23,5	35	13	8	19
05060801	chiusura ottone nichel	nr	100	23,5	35	13	8	19



Codice	Prodotto	U.m.	Conf.	A	L	M	H	H1
05060702	occhiello ovale ottone completo	nr	100		17	11	8	
05060802	occhiello ovale o.n. completo	nr	100		17	11	8	



Codice	Prodotto	U.m.	Conf.	L	M
80021711	punzone a martello turniquet	nr	1	17	11
80121711	fustella a martello turniquet	nr	1	17	11



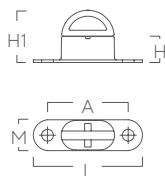

05.06 Turniquet

A richiesta zincato nero

Codice	Prodotto	U.m.	Conf.	A	L	M	H	H1
05060401	chiusura o.n.	nr	100	22	32	13	7,5	15
05060405	chiusura o.n. doppia altezza	nr	100	22	32	13	9,5	17



Codice	Prodotto	U.m.	Conf.	A	L	M
05060404	ranella o.n. per chiusura	nr	100	22	32	13



Codice	Prodotto	U.m.	Conf.	A	L	M
05060402	occhiello ovale o.n.	nr	100		15	9 7



Codice	Prodotto	U.m.	Conf.	L	M
05060403	ranella ovale o.n. per occhiello	nr	100	17	10

A richiesta colore nero



Codice	Prodotto	U.m.	Conf.	L	H
80020814	punzone a martello turniquet	nr	1	15	9



Codice	Prodotto	U.m.	Conf.	L	M
80371509	punzone per torchio turniquet	nr	1	15	9



Codice	Prodotto	U.m.	Conf.	L	H
80120814	fustella a martello turniquet	nr	1	15	9



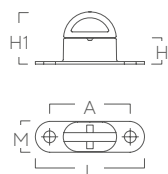

05.06 Turniquet

A richiesta zincato nero

Codice	Prodotto	U.m.	Conf.	A	L	M	H	H1
05060501	chiusura o.n.	nr	100	28	40	12	11	24
05060505	chiusura o.n. doppia altezza	nr	100	28	40	12	14	27

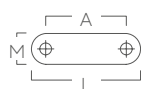

Codice	Prodotto	U.m.	Conf.	A	L	M
05060504	ranella o.n. per chiusura	nr	100	28	42	12

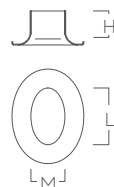

Codice	Prodotto	U.m.	Conf.	L	M	H
05060502	occhiello ovale o.n.	nr	100	19,5	12	9



Codice	Prodotto	U.m.	Conf.	L	M
05060503	ranella ovale o.n. per occhiello	nr	100	22	14

A richiesta colore nero



Codice	Prodotto	U.m.	Conf.	L	M
80021811	punzone a martello turniquet	nr	1	19,5	12



Codice	Prodotto	U.m.	Conf.	L	M
80371912	punzone per torchio turniquet	nr	1	19,5	12



Codice	Prodotto	U.m.	Conf.	L	M
80121811	fustella a martello turniquet	nr	1	19,5	12



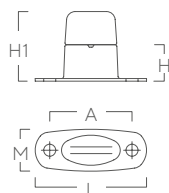

05.06 Common sense®

Codice	Prodotto	U.m.	Conf.	A	L	M	H	H1
05060111	chiusura o.n.	nr	100	23	32	12	10,5	20

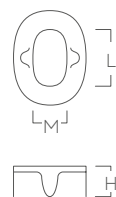

Codice	Prodotto	U.m.	Conf.	L	M
05060112	occhiello dentato o.n.	nr	100	17	10



Codice	Prodotto	U.m.	Conf.	L	M
05060113	ranella piatta o.n.	nr	100	15	9



Codice	Prodotto	U.m.	Conf.	L	M
05060114	ranella con fori o.n.	nr	100	16	10

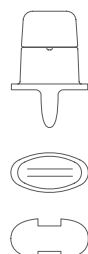

05.06 Common sense®

Codice	Prodotto	U.m.	Conf.
05060115	chiusura o.n. per tessuti	nr	100
05060116	piastra o.n. per tessuti	nr	100



05.06 Lift the DOT®

Codice	Prodotto	U.m.	Conf.	D
05060118	ranella	nr	100	17,85



Codice	Prodotto	U.m.	Conf.
05060117	ranella con fori o.n.	nr	100



Codice	Prodotto	U.m.	Conf.
05060119	vite autofilettante o.n.	nr	100



Codice	Prodotto	U.m.	Conf.	L	H
05060120	gabbia o.n.	nr	100	5,21	205
05060121	gabbia o.n.	nr	100	6,99	275





05.06 DOT Durable®

Codice	Prodotto	U.m.	Conf.
05060122	Velvet™ dentato per tappeti o.n.	nr	100



Codice	Prodotto	U.m.	Conf.
05060123	Velvet™ ranella per tappeti o.n.	nr	100



Codice	Prodotto	U.m.	Conf.
05060124	Dot - godronato o.n. diam.14mm	nr	100



Codice	Prodotto	U.m.	Conf.
05060126	Dot - vite o.n. l.22mm	nr	100



Codice	Prodotto	U.m.	Conf.
05060129	Dot - ranella o.n.20x24mm	nr	100





05.06 Turniquet DOT

Codice	Prodotto	U.m.	Conf.
85050510	pinza per DOT senza ricambi	nr	1

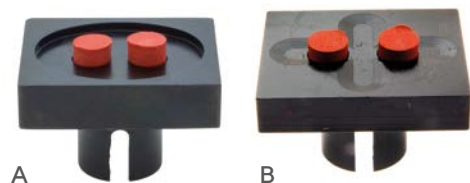

Codice	Prodotto	U.m.	Conf.
80370040	punzoni per bottoni dot parte inferiore	A nr	1
80370041	punzoni per bottoni dot parte superiore	B nr	1



Codice	Prodotto	U.m.	Conf.
80170510	fustella dot per 05060112	nr	1
80170512	fustella dot per 05060115	nr	1



05.07 Punti P7

Codice	Prodotto	U.m.	Conf.	L
050701AI	punto P7 acciaio inox 304	nr	2.500	20,6
050701FZ	punto P7 f.z.	nr	2.500	20,6

Codice	Prodotto	U.m.	Conf.
85050507	pinza per punti P7	nr	1



05.08 Fascetta per corda elastica

Codice	Prodotto	U.m.	Conf.	A	L
05080101	mm 08 grandi f.z. per corda Ø6-8 mm	nr	750	25	10



Codice	Prodotto	U.m.	Conf.	A	L
05080102	mm 08 piccole f.z. per corda Ø6-8 mm	nr	1.500	12	10

A richiesta acciaio inox



Codice	Prodotto	U.m.	Conf.	A	L
05080105	mm 10 grandi f.z. per corda Ø10 mm	nr	500	20	19





05.08 Fascette ovali per corda elastica f.z.

Codice	Prodotto	U.m.	Conf.	L	D
05080106	mm 06	nr	100	14	6
05080108	mm 08	nr	100	19	8
05080110	mm 10	nr	100	22,5	10

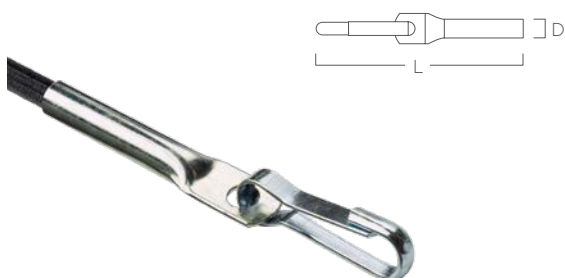

05.08 Capocorda con molla simplex f.z.

Codice	Prodotto	U.m.	Conf.	D	L	L1
05080116	mm 06 con molla mm 40	nr	100	6	57	90
05080118	mm 08 con molla mm 50	nr	100	8	70	120
05080120	mm 10 con molla mm 55	nr	100	10	72	122



05.08 Capocorda senza molla simplex f.z.

Codice	Prodotto	U.m.	Conf.	D	L
05080216	mm 06	nr	100	6	57
05080218	mm 08	nr	100	8	70
05080220	mm 10	nr	100	10	72



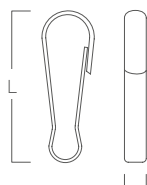

05.15 Molle simplex

Codice	Prodotto	U.m.	Conf.	L
05150040	mm 40 f.z.	nr	1.000	40
05150050	mm 50 f.z.	nr	1.000	50
05150060	mm 60 f.z.	nr	1.000	60
05150070	mm 70 f.z.	nr	1.000	70
05150080	mm 80 f.z.	nr	1.000	80
05150090	mm 90 f.z.	nr	1.000	90
05150100	mm 100 f.z.	nr	1.000	100

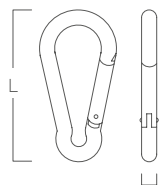

05.11 Moschettoni

Codice	Prodotto	U.m.	Conf.	D	L
05110040	mm 40 f.z.	nr	100	4	40
05110050	mm 50 f.z.	nr	100	5	50
05110060	mm 60 f.z.	nr	100	6	60
05110070	mm 70 f.z.	nr	100	7	70
05110080	mm 80 f.z.	nr	100	8	80
05110090	mm 90 f.z.	nr	100	9	90
05110100	mm 100 f.z.	nr	100	10	100
05110041	mm 40 acciaio inox 316	nr	100	4	40
05110051	mm 50 acciaio inox 316	nr	100	5	50
05110061	mm 60 acciaio inox 316	nr	100	6	60
05110071	mm 70 acciaio inox 316	nr	100	7	70
05110081	mm 80 acciaio inox 316	nr	100	8	80
05110091	mm 90 acciaio inox 316	nr	100	9	90
05110101	mm 100 acciaio inox 316	nr	100	10	100



05.13 Moschettoni nylon

Codice	Prodotto	U.m.	Conf.	D	L
05130006	moschettone nylon a carabina mm 05 nero	nr	100	5	47
05130008	moschettone nylon a carabina mm 08 nero	nr	100	8	73



05.13 Moschettoni MOPLEN

Codice	Prodotto	U.m.	Conf.	L
05130062	mm 62 bianco	nr	250	62
05130063	mm 62 azzurro	nr	250	62

A richiesta altri colori



05.13 Moschettoni nylon

Codice	Prodotto	U.m.	Conf.	L
05130200	mm 20* nylon bianco	nr	100	58
05130250	mm 25* nylon bianco	nr	100	58
05130300	mm 30* nylon bianco	nr	100	58
05130400	mm 40* nylon bianco	nr	100	58

*Passaggio nastro

A richiesta colore nero



05.14 Moschettone rotante

Codice	Prodotto	U.m.	Conf.	L
05140254	mm 25* nero	nr	100	69
05140304	mm 30* nero	nr	100	69

*Passaggio nastro





05.12 Moschettoni acciaio inox

Codice	Prodotto	U.m.	Conf.
05120020	55x28 A.I. 304 per nastro da mm 20	nr	100



07.03 Moschettoni nylon

Codice	Prodotto	U.m.	Conf.	D	L
070326NY	gancio sponda nylon Ø 06	nr	500	6	50
070328NY	gancio sponda nylon Ø 08	nr	500	8	58
070330NY	gancio sponda nylon Ø 10	nr	250	10	70



Codice	Prodotto	U.m.	Conf.	L
07099900	Ranella gancio cestello Ø 8 mm	nr	250	8



Codice	Prodotto	U.m.	Conf.
85050507	pinza per punti P7	nr	1

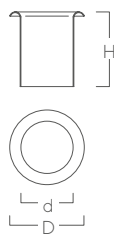

05.20 Chiusure speciali

Codice	Prodotto	U.m.	Conf.	d	D	H
05200010	bussola tubo acciaio inox 304	nr	100	28	40	30
05200011	bussola tubo ottone giallo	nr	100	23		25
05200013	bussola tubo acciaio inox 304	nr	100	29	32	25

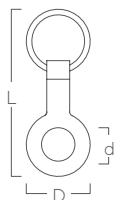

05.20 Chiusure speciali Piastre ST C/AN

Codice	Prodotto	U.m.	Conf.	d	D	L
05200015	57/10 zincato fuoco	nr	100	34	65	170

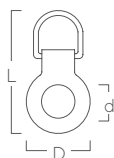

Codice	Prodotto	U.m.	Conf.	d	D	L
05200016	40/6.5 zincato fuoco	nr	100	34	65	125

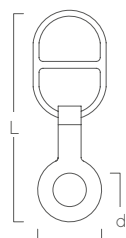

Codice	Prodotto	U.m.	Conf.	d	D	L
05200017	doppio anello 57/10 zincato fuoco	nr	100	34	65	220

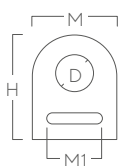

Codice	Prodotto	U.m.	Conf.	D	M	M1	H
05200018	mm 34 zincato fuoco bordi arrotondati	nr	100	33	85	60	110



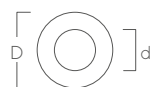

05.20 Chiusure speciali ranelle bombate

Codice	Prodotto	U.m.	Conf.	d	D
05200020	zincato per bussola 25/23	nr	100	25	65
05200021	zincato fuoco	nr	100	34	65
05200021A1	acciaio inox 304	nr	100	34	65

A richiesta stampi per occhiellatrice mod. 300 per applicazione bussola e ranelle bombate

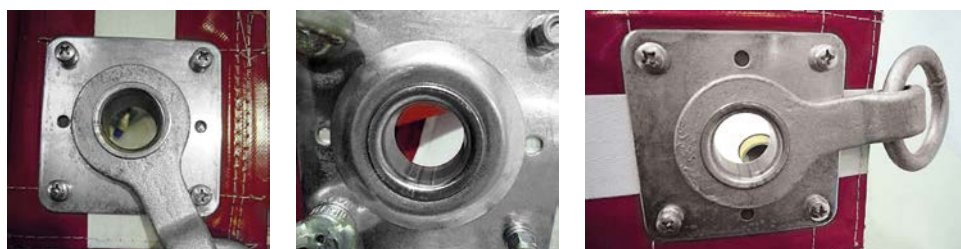

05.6 Calamite

Codice	Prodotto	U.m.	Conf.	d	D
05602003	calamita Neod tonda 20x3 foro 3,2	nr	1	3,2	20

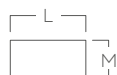

Codice	Prodotto	U.m.	Conf.	L	M
05630105	calamita Neod rettangolare mm 30x10x5	nr	1	30	10



05.25 Maniglie f.z.

Codice	Prodotto	U.m.	Conf.
052510DX	destra completa di piastra	nr	10 1
052510SX	sinistra completa di piastra	nr	10 2

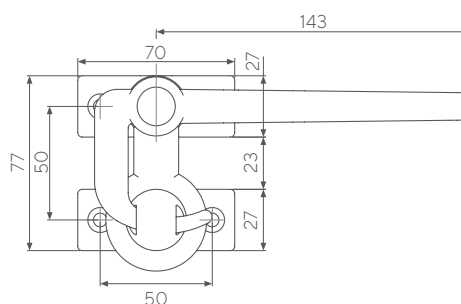

05.25 Maniglie f.z.

Codice	Prodotto	U.m.	Conf.
052515DX	snodata destra completa di piastra	nr	10 1
052515SX	snodata sinistra completa di piastra	nr	10 2

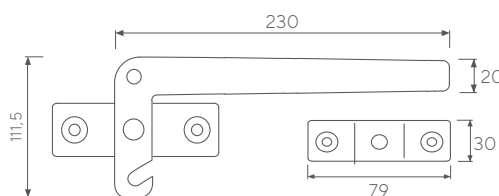

Codice	Prodotto	U.m.	Conf.
052515DXR	rinforzata destra completa di piastra	nr	10 1
052515SXR	rinforzata sinistra completa di piastra	nr	10 2





05.25 Maniglie f.z.

Codice	Prodotto	U.m.	Conf.
052516DX	snodata destra completa di piastra	nr	10 1
052516SX	snodata sinistra completa di piastra	nr	10 2

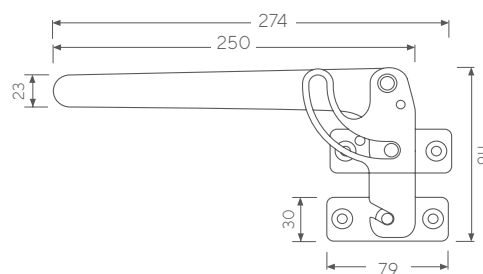

05.25 Maniglie acciaio inox 304

Codice	Prodotto	U.m.	Conf.
052520DX	snodata destra completa di piastra	nr	10 1
052520SX	snodata sinistra completa di piastra	nr	10 2

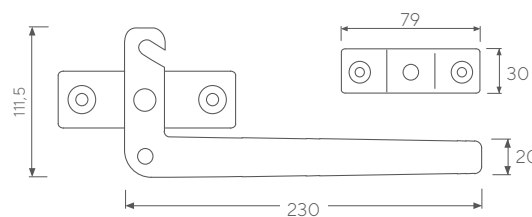

Codice	Prodotto	U.m.	Conf.
052520DXR	rinforzata destra completa di piastra	nr	10 1
052520SXR	rinforzata sinistra completa di piastra	nr	10 2



05.25 Maniglie acciaio inox 304

Codice	Prodotto	U.m.	Conf.
052521DX	snodata destra completa di piastra	nr	10 1
052521SX	snodata sinistra completa di piastra	nr	10 2

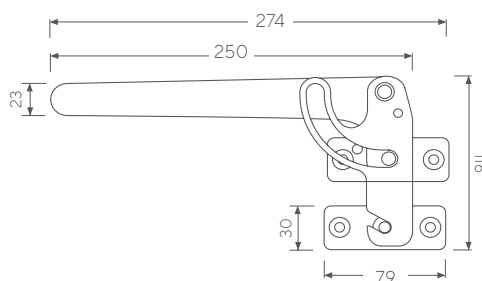

05.25 Maniglie lamiera elettrozincata + materiale plastico

Codice	Prodotto	U.m.	Conf.
052522DX	destra tiraggio 9mm con guida e contropiastra	nr	10 1
052522SX	snodata tiraggio 9mm con guida e contropiastra	nr	10 2

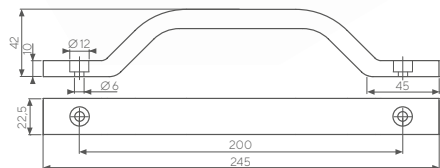

05.25 Maniglie plastica

Codice	Prodotto	U.m.	Conf.
05253000	PVC nera	nr	10

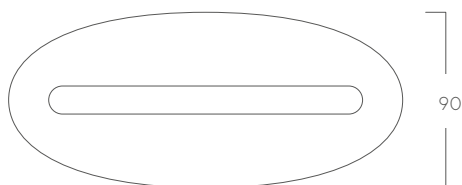

Codice	Prodotto	U.m.	Conf.
05253000S	PVC nera saldabile	nr	10

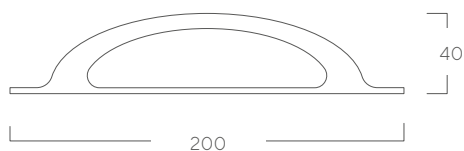



05.25 Chiavistelli f.z.

Codice	Prodotto	U.m.	Conf.
052550FZ	chiavistello a molla perno corto	nr	10
052555FZ	chiavistello a molla perno lungo	nr	10



05.25 Chiavistelli acciaio inox 304

Codice	Prodotto	U.m.	Conf.
052560AI	chiavistello a molla perno corto	nr	10
052565AI	chiavistello a molla perno lungo	nr	10

Perno corto

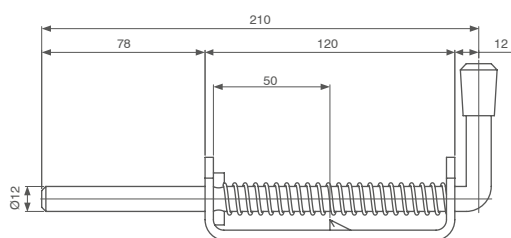

Perno lungo

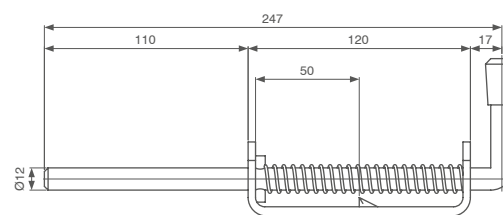



05.25 Chiavistelli f.z.

Codice	Prodotto	U.m.	Conf.
052556FZ	chiavistello L45cmx80mm perno d 18mm	nr	1



05.59 Chiavistelli acciaio inox

Codice	Prodotto	U.m.	Conf.
055960AI	chiavistello L31cmx48mm d10mm	nr	1

CHIUSURE COMPLETE

ESEMPIO DI UTILIZZO





Articolo

25192405 binario in acciaio zincato per ruota Ø 24

25194405 binario in acciaio zincato per ruota Ø 44

Articolo

25022403 Ø 24 due cuscinetti piastra piegata

25042402 Ø 24 quattro cuscinetti piastra piegata

25024402 Ø 44 due cuscinetti con fori



Articolo

32300060 doppia ogiva alluminio

32353605 alluminio anodizzato 17x44 mm

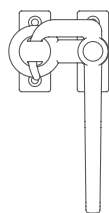
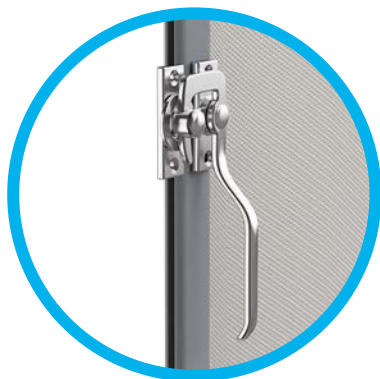

Articolo

052510DX maniglia dx f.z. completa di piastra

052510SX maniglia sx f.z. completa di piastra

052515DX maniglia snodata dx completa di piastra

052515SX maniglia snodata sx completa di piastra

052515DXR maniglia rinforzata dx completa di piastra

052515SXR maniglia rinforzata sx completa di piastra

052516DX maniglia snodata dx completa di piastra

052516SX maniglia snodata sx completa di piastra

052520DX maniglia snodata dx completa di piastra

052520SX maniglia snodata sx completa di piastra

052520DXR maniglia rinforzata dx completa di piastra

052520SXR maniglia rinforzata sx completa di piastra

052521DX maniglia snodata dx completa di piastra

052521SX maniglia snodata sx completa di piastra

052522DX maniglia snodata dx completa di piastra

052522SX maniglia snodata sx completa di piastra



Articolo

05253000 maniglia PVC nera

05253000S maniglia PVC nera saldabile

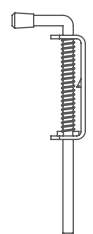

Articolo

052550FZ chiavistello a molla f.z. perno corto

052555FZ chiavistello a molla f.z. perno lungo

052556FZ chiavistello f.z.

052560AI chiavistello a molla INOX perno corto

052565AI chiavistello a molla INOX perno lungo

055960AI chiavistello acciaio INOX

/
ZEROSSETTE

Ganci
& Contropiastre

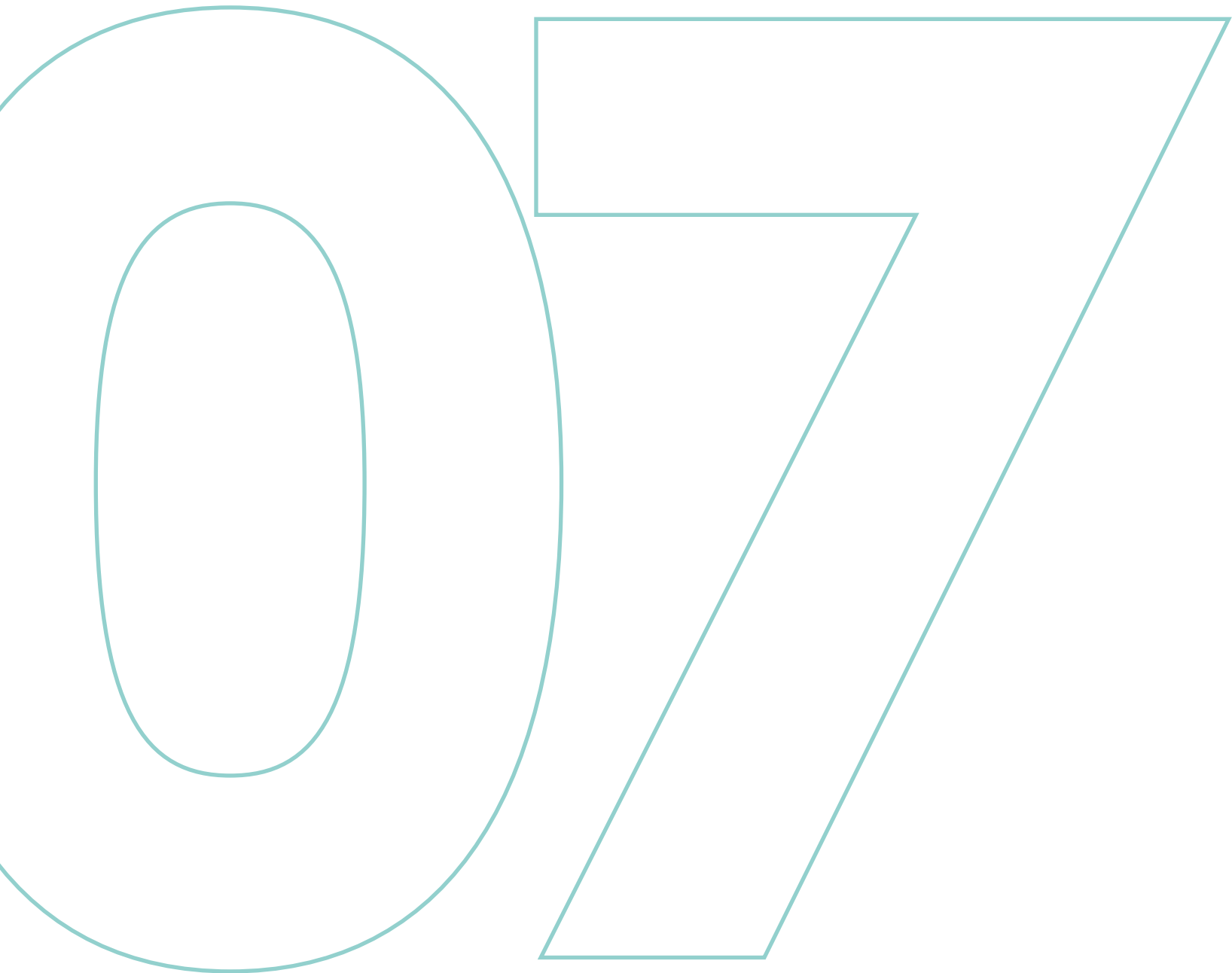

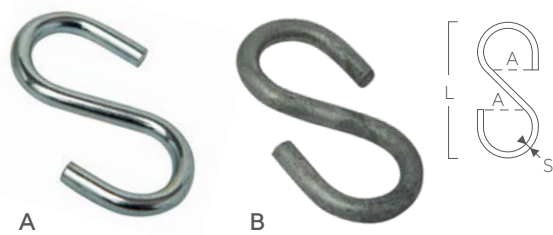

07.01 Ganci S

Codice	Prodotto	U.m.	Conf.	L	S	A
070101AI	aperto acciaio inox 304	nr	500	44	4	10
070101FZ	aperto f.z.	A nr	500	45	4	10
070101ZF	aperto zincato fuoco	B nr	500	45	4	10

a richiesta verniciato nero



070106FZ	aperto f.z.	C nr	100	30	3	6
070107FZ	aperto f.z.	D nr	500	40	3,8	7
070109FZ	aperto f.z.	E nr	100	55	6	10



07.01 Ganci S

Codice	Prodotto	U.m.	Conf.	L	S	A
070102FZ	chiuso f.z.	nr	500	50	4	18
070102AI	chiuso acciaio inox 304	nr	500	50	4	18

a richiesta verniciato nero

070102ZF	chiuso zincato fuoco	nr	500	50	4	18
-----------------	----------------------	----	-----	----	---	----



07.01 Ganci S

Codice	Prodotto	U.m.	Conf.	L	S	A
070103FZ	aperto girato f.z.	nr	500	45	4	10



07.01 Ganci S

Codice	Prodotto	U.m.	Conf.	L	S	A
070104FZ	chiuso girato f.z.	nr	500	50	4	23

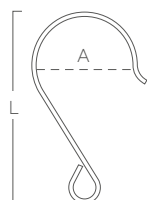

07.01 Ganci S

Codice	Prodotto	U.m.	Conf.	L	A
070110A	allargato acciaio C72	nr	100	93	37





A



B

07.03 Ganci sponda

Codice	Prodotto	U.m.	Conf.	A	L	M	
070302FZ	mm 72x20 f.z.	A	nr	100	20	72	20
070304FZ	mm 55x13 f.z.	B	nr	100	20	55	13



07.03 Ganci sponda

Codice	Prodotto	U.m.	Conf.	A	L	M
070303FZ	a becco f.z.	nr	500	40	59	21



07.03 Ganci S chiusi per gommoni

Codice	Prodotto	U.m.	Conf.	L	M
070303NY	nylon grigio	nr	500	41	39
070304NY	nylon nero	nr	500	41	39
070305NY	nylon bianco	nr	500	41	39

Per corda elastica Ø 6 mm e Ø 8 mm



07.03 Ganci S stretti

Codice	Prodotto	U.m.	Conf.	L	M
070306NY	nylon fibra di vetro bianco	nr	100	41	25
070307NY	nylon fibra di vetro grigio	nr	100	41	25
070308NY	nylon fibra di vetro nero	nr	100	41	25

Per corda elastica Ø 6 mm e Ø 8 mm



07.03 Ganci sponda S larghi

Codice	Prodotto	U.m.	Conf.	L	M
070310NY	nylon bianco	nr	500	37	36
070314NY	nylon nero	nr	500	37	36

Per corda elastica Ø 6 mm e Ø 8 mm



07.03 Ganci per copricanotti

Codice	Prodotto	U.m.	Conf.	L	M
070318NY	nylon nero	nr	100	41	36
070319NY	nylon bianco	nr	100	41	36

Per corda elastica Ø 6 mm e Ø 8 mm

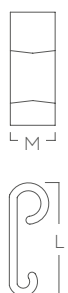

07.03 Ganci sponda doppi per corda elastica mm 08

Codice	Prodotto	U.m.	Conf.	L	M
070320NY	nylon bianco	nr	100	50	20
070324NY	nylon nero	nr	100	50	20

Per corda elastica Ø 6 mm e Ø 8 mm



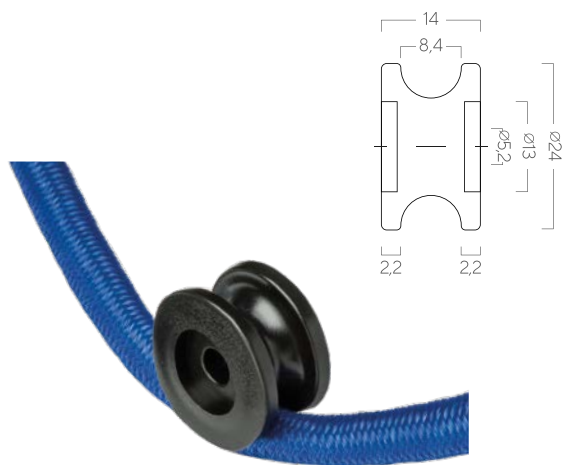

07.03 Ganci tondi per corda elastica

Codice	Prodotto	U.m.	Conf.
070321NY	nylon nero	nr	100
070322NY	nylon grigio	nr	100
070323NY	nylon bianco	nr	100
070325NY	nylon avorio	nr	100
070327NY	nylon marrone	nr	100

Per corda elastica Ø 6 mm e Ø 8 mm



07.03 Bottoni

Codice	Prodotto	U.m.	Conf.	D1	D2	D3	L
070335NY	bottone tondo bianco per gazebo	nr	500	5	15	30	10,5

Per corda elastica Ø 6 mm e Ø 8 mm



05.13 Moschettoni MOPLEN

Codice	Prodotto	U.m.	Conf.	L
05130062	mm 62 bianco	nr	100	62
05130063	mm 62 azzurro	nr	100	62



07.03 Moschettoni

Codice	Prodotto	U.m.	Conf.	D	L
070326NY	nylon Ø 06	nr	500	6	50
070328NY	nylon Ø 08	nr	500	8	58
070330NY	nylon Ø 10	nr	250	10	70



07.03 Ganci sponda

Codice	Prodotto	U.m.	Conf.	A	L	M
070332NY	nylon jeep nero	nr	100	24	39	18

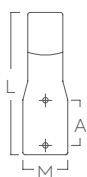

07.05 Ganci Zig Zag

Codice	Prodotto	U.m.	Conf.	A	L	M
070501AA	nylon aperto "A"	nr	1.000	20	60	22



07.05 Ganci Zig Zag

Codice	Prodotto	U.m.	Conf.	A	L	M
070501CA	nylon aperto "C"	nr	1.000	20	63	20



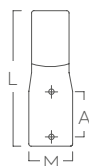

07.05 Ganci Zig Zag

Codice	Prodotto	U.m.	Conf.	A	L	M
070501TA	nylon aperto "T" neutro	nr	100	20	60	19,5
070501TAB	nylon aperto "T" bianco	nr	100	20	60	19,5
070501TAG	nylon aperto "T" grigio	nr	100	20	60	19,5
070501TAN	nylon aperto "T" nero	nr	100	20	60	19,5

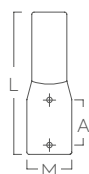

07.05 Ganci Zig Zag

Codice	Prodotto	U.m.	Conf.	A	L	M	D
070502CC	nylon chiuso "C" neutro	nr	1.000	20	63	20	17,5
070502CCB	nylon chiuso "C" bianco	nr	1.000	20	63	20	17,5
070502CCG	nylon chiuso "C" grigio	nr	1.000	20	63	20	17,5
070502CCN	nylon chiuso "C" nero	nr	1.000	20	63	20	17,5

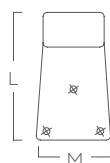

07.05 Ganci Zig Zag

Codice	Prodotto	U.m.	Conf.	L	M
070510CDS	nylon doppio bianco	nr	1.000	60	35
070514CDS	nylon doppio nero	nr	1.000	60	35



Codice	Prodotto	U.m.	Conf.	L	M
070510CD	nylon doppio bianco	nr	1.000	66	35

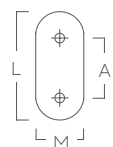

07.05 Piastrine

Codice	Prodotto	U.m.	Conf.	A	L	M
070599RI	nylon rivetto incorporato mm 9,2 (09050459)	nr	1.000	20	36	16
070599RIL	nylon rivetto incorporato mm 10,5 (09051512)	nr	1.000	20	36	16

A richiesta colore grigio e nero



07.05 Piastrine

Codice	Prodotto	U.m.	Conf.	A	L	M
070599NY	nylon senza rivetto bianca	nr	1.000	20	36	16
070599NYN	nylon senza rivetto nera	nr	1.000	20	36	16

A richiesta colore grigio

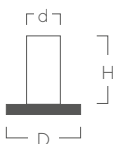

Codice	Prodotto	U.m.	Conf.	A	L	M
09050459	mm 4,5 x 9,2 ottone nichel	nr	5.000	9,7	4,5	9,2
09051512	mm 4,5 x 10,5 ottone nichel	nr	5.000	9,2	4,5	10,5



07.05 Piastrine

Codice	Prodotto	U.m.	Conf.	D	H
070599PV	gomma/pvc rotonda mm 22 x 4,5 x 2 nero	nr	1.000	22	2
070599RO	nylon tonda mm16 per ganci ZigZag	nr	1.000	16	2



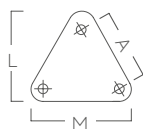

07.06 Piastrine

Codice	Prodotto	U.m.	Conf.	A	L	M
070600RIC	nylon riv. inc. mm 9,2 (09050459)	nr	1.000	20	30	33
070600RIL	nylon riv. inc. mm 10,5 (09051512)	nr	1.000	20	30	33

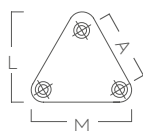

07.06 Piastrine

Codice	Prodotto	U.m.	Conf.	A	L	M
070600NY	nylon senza rivetto	nr	1.000	20	30	33

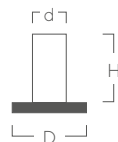

Codice	Prodotto	U.m.	Conf.	D	d	H
09050459	mm 4,5 x 9,2 ottone nichel	nr	5.000	9,7	4,5	9,2
09051512	mm 4,5 x 10,5 ottone nichel	nr	5.000	9,2	4,5	10,5

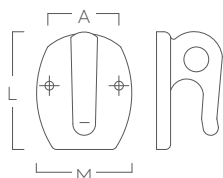

07.07 Ganci Cobra

Codice	Prodotto	U.m.	Conf.	A	L	M
070701PB	nylon piccolo	nr	1.000	26	45	38

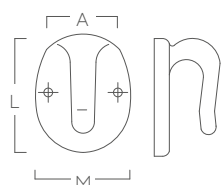

07.07 Ganci Cobra

Codice	Prodotto	U.m.	Conf.	A	L	M
070701PE	nylon piccolo senza passante	nr	1.000	26	45	38

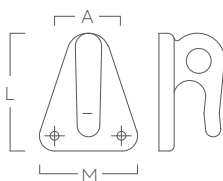

07.07 Ganci Cobra

Codice	Prodotto	U.m.	Conf.	A	L	M
070701PT	nylon piccolo triangolo	nr	1.000	28	47	39

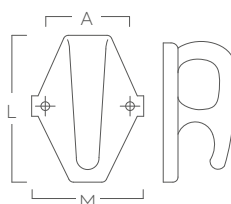

07.07 Ganci Cobra

Codice	Prodotto	U.m.	Conf.	A	L	M
070702MA	nylon medio alette	nr	1.000	35	57	49



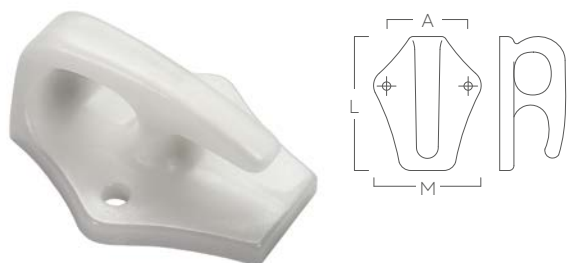

07.07 Ganci Cobra

Codice	Prodotto	U.m.	Conf.	A	L	M
070702MB	nylon medio bianco	nr	1.000	30	55	45
070702MG	nylon medio grigio	nr	1.000	30	55	45



07.07 Ganci Cobra

Codice	Prodotto	U.m.	Conf.	A	L	M
070703GB	nylon grande bianco	nr	1.000	30	55	47
070704GB	nylon grande nero	nr	1.000	30	55	47
070705GB	nylon grande grigio	nr	1.000	30	55	47



07.09 Ganci cestello

Codice	Prodotto	U.m.	Conf.
07090601	f.z. bianco Ø 06 con ranella	nr	250
07090801	f.z. bianco Ø 08 con ranella	nr	250
07091001	f.z. bianco Ø 10 con ranella	nr	250

Codice	Prodotto	U.m.	Conf.
07099900	ranella gancio cestello Ø 6 e 8 mm	nr	250
07099901	ranella gancio cestello Ø 10 mm	nr	250





07.09 Ganci cestello

Codice	Prodotto	U.m.	Conf.	L
07092801	ricoperto f.z. Ø08 senza ranella	nr	100	72



07.09 Clip Serravela

Codice	Prodotto	U.m.	Conf.	D*
07095000	Gancio/Clip serravele bianco	nr	100	5
07095004	Gancio/Clip serravele nero	nr	100	5

*Per corda elastica 5mm

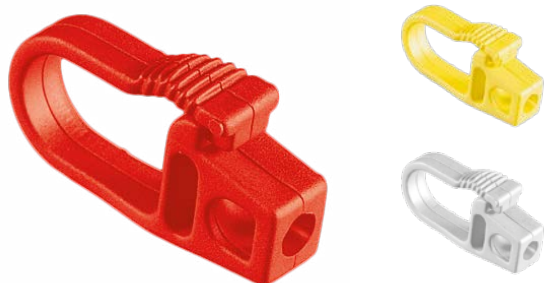

07.09 Ganci tenditelo con sicura polipolipropilene

Codice	Prodotto	U.m.	Conf.	L	M
07096500	Ø 06 bianco	nr	100	65	35
07096506	Ø 06 rosso	nr	100	65	35
07096507	Ø 06 giallo	nr	100	65	35

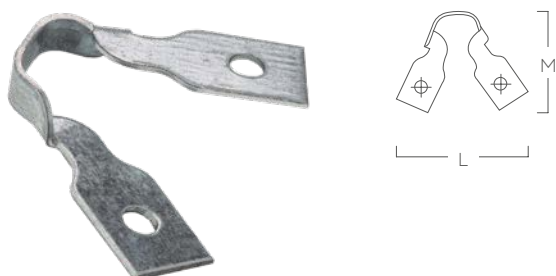

07.20 Ganci per striscioni

Codice	Prodotto	U.m.	Conf.	L	M
07203501	singolo f.z.	nr	100	35	34

Utilizzabile con anelli tondi 18.01



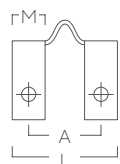

07.20 Ganci per striscioni

Codice	Prodotto	U.m.	Conf.	A	L	M
07203502	doppio f.z.	nr	100	20	35	12,5

Utilizzabile con anelli tondi 18.01



07.20 Ganci per striscioni

Codice	Prodotto	U.m.	Conf.	A	L	M
07203503	da utilizzare con art. 070599Rl	nr	100	20	30	36

Utilizzabile con anelli tondi 18.01

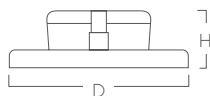

07.25 Ruck Zuck

Codice	Prodotto	U.m.	Conf.	D	d	H
07250000	chiusura per occhiello mm 25	nr	100	44	24	14

A richiesta chiave

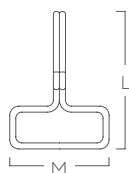

07.30 Ganci zaino

Codice	Prodotto	U.m.	Conf.	L	M	S
073003FZ	doppio f.z.	nr	500	45	33	3





A



B



07.32 Ganci per guaina

Codice	Prodotto	U.m.	Conf.	A	D	M
073222FZ	piegato f.z.	A	nr	100	20	15 8.80
073231FZ	dritto f.z.	B	nr	100	20	11 10

Piastra compatibile 070599RI-RIL





07.35 Ganci a sfera

Codice	Prodotto	U.m.	Conf.	D	L
07350010	nylon mm 08 con rivetti	pz	100	08	66
07350011	nylon mm 08 senza rivetti	pz	100	08	66

Profili compatibili

32300060	32300963	32301950	32303960
32300860	32300964	32301960	32353600
32300960	32300965	32302960	32353605



07.35 Ganci a sfera

Codice	Prodotto	U.m.	Conf.	D	L
07350020	nylon mm 12 con rivetti	pz	100	12	66
07350021	nylon mm 12 senza rivetti	pz	100	12	66

Profili compatibili

32300060	32301950	32301960
----------	----------	----------



07350022	nylon mm 15 con rivetti	pz	100	15	70
07350023	nylon mm 15 senza rivetti	pz	100	15	70



07.35 Ganci a T

Codice	Prodotto	U.m.	Conf.	D	L
07350025	nylon mm 10 con rivetti	pz	100	10	66
07350026	nylon mm 10 senza rivetti	pz	100	10	66

Profili compatibili

32300060	32301950	32353600
32300760	32301960	32353605



07.35 Ganci laterali

Codice	Prodotto	U.m.	Conf.	D	L
07350030	nylon mm 12 con rivetti	pz	100	12	73
07350031	nylon mm 12 senza rivetti	pz	100	12	73



07.35 Ganci laterali

Codice	Prodotto	U.m.	Conf.	D	L
07350035	nylon piatto mm 12 con rivetti	pz	100	12	66
07350036	nylon piatto mm 12 senza rivetti	pz	100	12	66

Profili compatibili

32300060	32301950	32301960
----------	----------	----------

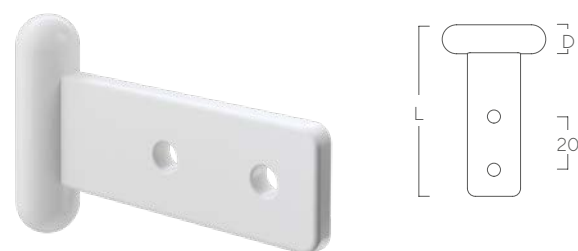

07.35 Ganci a T

Codice	Prodotto	U.m.	Conf.	D	L
07350041	nylon mm 11,2 senza rivetti	pz	100	11,2	64,5

Profili compatibili

32300060	32301950	32353600
32300760	32301960	32353605

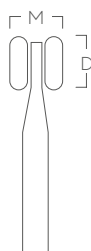

25.50 Carrelli nylon

Codice	Prodotto	U.m.	Conf.	D	M
25500100	2 ruote nylon	nr	100	16	13
25500200	2 ruote nylon con rivetto incorporato	nr	100	16	13



/
ZERONOVE

Rivetti





09.01 Rivetti testa e gambo

Codice	Prodotto	U.m.	Conf.	D	d	H
090133FN	33 ferro nichel	nr	5.000	7,0	3,0	8,0
090133ON	33 ottone nichel	nr	5.000	7,0	3,0	8,0



Codice	Prodotto	U.m.	Conf.	D	d	H
09013610	36 T.O. mm 10	nr	5.000	11,0	3,0	10,0
09013612	36 T.O. mm 12	nr	5.000	11,0	3,0	12,0
090136FG	36 ferro grezzo	nr	5.000	11,0	3,0	10,0
090136FZ	36 f.z.	nr	5.000	11,0	3,0	10,0
090136ON	36 ottone nichel	nr	5.000	11,0	3,0	10,0
090136FT	36 ferro tropical	nr	5.000	11,0	3,0	10,0



Codice	Prodotto	U.m.	Conf.	D	d	H
090137FG	37 ferro grezzo	nr	2.500	13,0	3,2	11,8
090137FT	37 ferro tropical	nr	2.500	13,0	3,2	11,8
090137FZ	37 f.z.	nr	2.500	13,0	3,2	11,8
090137ON	37 ottone nichel	nr	2.500	13,0	3,2	11,8



09.02 Rivetti doppia calotta

Codice	Prodotto	U.m.	Conf.	D	d	H
090136ON1+ON3	36 - mm 10 ottone nichel	nr	2.500	10	3,0	10
090236ON11ON	36 - mm 10 ottone nero	nr	2.500	10	3,0	10
090137ON1+ON3	37 - mm 12 ottone nichel	nr	2.500	13	3,5	13





09.05 Rivetti autoperforanti

Codice	Prodotto	U.m.	Conf.	D	d	H
09050508	mm 5,0 x 8,0 f.z.	nr	5.000	9,0	5,0	8,0
09050510	mm 5,0 x 10,0 f.z.	nr	5.000	9,2	5,0	10,0
09051510	mm 5,0 x 10,0 alluminio	nr	5.000	9,2	5,0	10,0
09050459	mm 4,5 x 9,2 ottone nichel	nr	5.000	9,7	4,5	9,20
09051512	mm 4,5 x 10,5 ottone nichel	nr	5.000	9,2	4,5	10,5



09.40 Rivetti calottati autoperforanti

Codice	Prodotto	U.m.	Conf.	D	d	H
094020FN	mm 40 x 77 x 90 ferro nichel	nr	5.000	9,0	4,0	7,7
094035FN	mm 40 x 97 x 110 ferro nichel	nr	5.000	11,0	4,0	9,7
094035FZ	mm 40 x 97 x 110 f.z.	nr	5.000	11,0	4,0	9,7



09.60 Collare e bulloni a strappo

Codice	Prodotto	U.m.	Conf.
09603534	collare svasato per bullone a strappo d.6,4 alluminio	nr	1.000
09606000	collare per bullone a strappo	nr	1.000
09606432	bullone a strappo d.6,4x32 alluminio	nr	1.000
09606442	bullone a strappo d.6,4x42 alluminio	nr	1.000
09606452	bullone a strappo d.6,4x52 alluminio	nr	1.000

A richiesta rivettatrice cod. 85900508

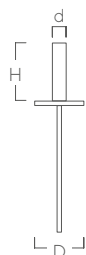

09.50 Rivetti a strappo alluminio / acciaio

Codice	Prodotto	U.m.	Conf.	D	d	H
09503810	mm 4 x 10	nr	500	4	8,0	10,0
09503811	mm 4 x 11	nr	500	4	8,0	11,0
09503814	mm 4 x 14	nr	500	4	8,0	14,0
09503816	mm 4 x 16	nr	500	4	8,0	16,0
09503818	mm 4 x 18	nr	500	4	8,0	18,0
09503820	mm 4 x 20	nr	500	4	8,0	20,0
09504810	mm 4,8 x 10	nr	500	4,8	9,5	10,0
09504812	mm 4,8 x 12	nr	500	4,8	9,5	12,0
09504814	mm 4,8 x 14	nr	500	4,8	9,5	14,0
09504816	mm 4,8 x 16	nr	500	4,8	9,5	16,0
09504818	mm 4,8 x 18	nr	500	4,8	9,5	18,0
09504820	mm 4,8 x 20	nr	500	4,8	9,5	20,0
09504824	mm 4,8 x 24	nr	500	4,8	9,5	24,0
09504826	mm 4,8 x 26	nr	500	4,8	9,5	26,0
09504828	mm 4,8 x 28	nr	500	4,8	9,5	28,0
09504830	mm 4,8 x 30	nr	500	4,8	9,5	30,0
09504835	mm 4,8 x 35	nr	500	4,8	9,5	35,0

A richiesta: altre misure - testa larga (TL) - tenuta stagna - finitura acciaio/acciaio





85.90 Rivettatrici

Codice	Prodotto	U.m.	Conf.
85900205	rivettatrice RIV 5 manuale per rivetti a strappo da 2,4 a 4,8 all.	nr	1

Codice	Prodotto	U.m.	Conf.
85900503	Rivettatrice 503 oleopneumatica per rivetti a strappo fino al d.4,8 (tutte le leghe) e d.6,0 solo alluminio	nr	1

Codice	Prodotto	U.m.	Conf.
85900504	Rivettatrice 504 oleopneumatica per rivetti a strappo fino al d. 6,4 (tutte le leghe)	nr	1

Codice	Prodotto	U.m.	Conf.
85900508	Rivettatrice 508 oleopneumatica per rivetti e bulloni a strappo fino al d. 6,4 (tutte le leghe)	nr	1

Codice	Prodotto	U.m.	Conf.
85900720	Rivettatrice 720 Batteria Litio 18.0V 2,0Ah per rivetti a strappo fino d.6,4 con 2 batterie + caricabatteria	nr	1



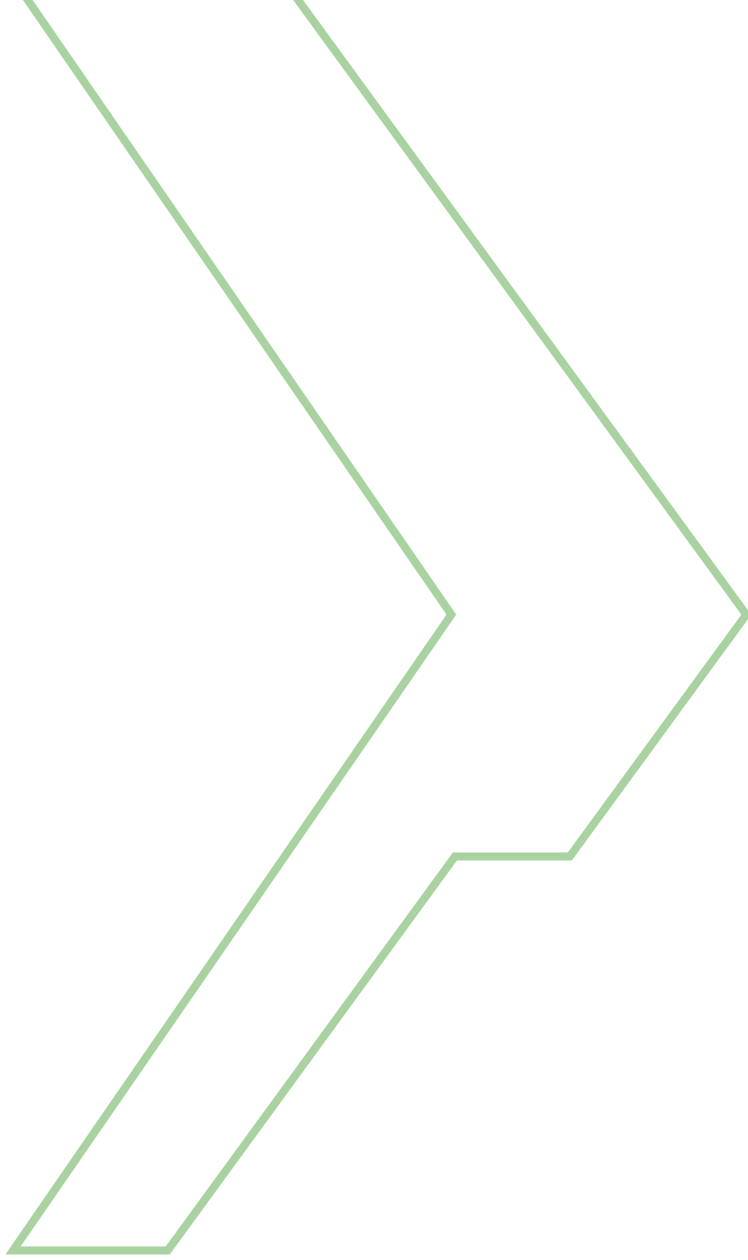

/
UNDICI

Cavi tir, corde elastiche
e trecce



undici

→ cavi tir, corde elastiche e trecce

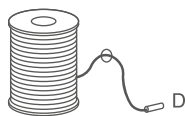

11



11.01 Cavo TIR acciaio su rotolo

Codice	Prodotto	U.m.	Conf.	L	D
11010601	Ø 6 acciaio mt 100	mt	100	100	6
11010602	Ø 6 acciaio mt 250	mt	250	250	6
11010603	Ø 6 acciaio mt 300	mt	300	300	6
11010605	Ø 6 acciaio mt 500	mt	500	500	6
11010801	Ø 8 acciaio mt 100	mt	100	100	8
11010803	Ø 8 acciaio mt 300	mt	300	300	8
11010806	Ø 8 acciaio mt 600	mt	600	600	8



11.01 Cavo TIR acciaio pesante su rotolo

Codice	Prodotto	U.m.	Conf.	L	D
11010602T	Ø 6 acciaio pesante mt 250	mt	250	250	6
11010802T	Ø 8 acciaio pesante mt 250	mt	250	250	8



undici

→ cavi tir, corde elastiche e trecce

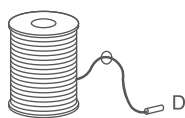

11



11.05 Cavo TIR acciaio con capocorda

Codice	Prodotto	U.m.	Conf.	L	D
110506202	Ø 06 mt 20,2	nr	10	20,2	6
11050621	Ø 06 mt 21	nr	10	21	6
11050622	Ø 06 mt 22	nr	10	22	6
11050633	Ø 06 mt 33	nr	10	33	6
11050634	Ø 06 mt 34	nr	10	34	6
11050636	Ø 06 mt 36	nr	10	36	6
11050638	Ø 06 mt 38	nr	10	38	6
11050640	Ø 06 mt 40	nr	10	40	6
11050646	Ø 06 mt 46	nr	10	46	6
110508202	Ø 08 mt 20,2	nr	10	20,2	8
110508222	Ø 08 mt 22,2	nr	10	22,2	8
11050833	Ø 08 mt 33	nr	10	33	8
110508332	Ø 08 mt 33,2	nr	10	33,2	8
11050834	Ø 08 mt 34	nr	10	34	8
110508342	Ø 08 mt 34,2	nr	10	34,2	8
110508352	Ø 08 mt 35,2	nr	10	35,2	8
11050836	Ø 08 mt 36	nr	10	36	8

Altre misure a richiesta



11.10 Cavo TIR nylon su rotolo

Codice	Prodotto	U.m.	Conf.	L	D
11100501	Ø 5 nylon mt 100	mt	100	100	5
11100503	Ø 5 nylon mt 300	mt	300	300	5
11100506	Ø 5 nylon mt 600	mt	600	600	5
11100601	Ø 6 nylon mt 100	mt	100	100	6
11100603	Ø 6 nylon mt 300	mt	300	300	6
11100606	Ø 6 nylon mt 600	mt	600	600	6
11100703	Ø 7 nylon mt 300	mt	300	300	7
11100801	Ø 8 nylon mt 100	mt	100	100	8
11100803	Ø 8 nylon mt 300	mt	300	300	8
11100806	Ø 8 nylon mt 600	mt	600	600	8



undici

→ cavi tir, corde elastiche e trecce

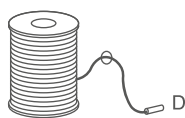

11



11.15 Cavo TIR nylon con capocorda

Codice	Prodotto	U.m.	Conf.	L	D
11150633	nylon Ø 06 mt.33	nr	20	33	6
11150634	nylon Ø 06 mt.34	nr	20	34	6
11150833	nylon Ø 08 mt.33	nr	20	33	8
11150834	nylon Ø 08 mt.34	nr	20	34	8

Altre misure a richiesta



11.18 Tondini trasparente

Codice	Prodotto	U.m.	Conf.	L	D
11180601T	trasparente mm 06 mt 100	mt	100	100	6
11180801T	trasparente mm 08 mt 100	mt	100	100	8
11180901T	trasparente mm 09 mt 100	mt	100	100	9
11181001T	trasparente mm 10 mt 100	mt	100	100	10



11.18 Tondini silver

Codice	Prodotto	U.m.	Conf.	L	D
11180601S	silver mm 06 mt 100	mt	100	100	6



undici

→ cavi tir, corde elastiche e trecce

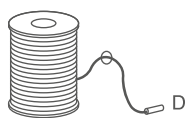

11



Monofilo
di polietilene

11.20 Corda elastica su rotolo Ø 3-4-5 mm

Codice	Prodotto	U.m.	Conf.	D
11200304	Ø 03 mm bianca	ml	300	3
11200344	Ø 03 mm nera	ml	300	3
11200404	Ø 04 mm bianca	ml	300	4
11200474	Ø 04 mm nera	ml	300	4
11200504	Ø 05 mm bianca	ml	300	5
11200544	Ø 05 mm nera	ml	300	5

A richiesta altri colori



Monofilo
di polietilene

11.20 Corda elastica su rotolo Ø 6 mm

Codice	Prodotto	U.m.	Conf.	D
11200601	Ø 06 mm bianca	ml	100	6
11200611	Ø 06 mm blu	ml	100	6
11200621	Ø 06 mm gialla	ml	100	6
11200631	Ø 06 mm grigia	ml	100	6
11200641	Ø 06 mm nera	ml	100	6
11200651	Ø 06 mm rossa	ml	100	6
11200661	Ø 06 mm verde	ml	100	6
11200681	Ø 06 mm verde militare	ml	100	6
11200691	Ø 06 mm avorio	ml	100	6
11200603	Ø 06 mm bianca	ml	300	6
11200613	Ø 06 mm blu	ml	300	6
11200623	Ø 06 mm gialla	ml	300	6
11200633	Ø 06 mm grigia	ml	300	6
11200643	Ø 06 mm nera	ml	300	6
11200653	Ø 06 mm rossa	ml	300	6
11200663	Ø 06 mm verde	ml	300	6
11200683	Ø 06 mm verde militare	ml	300	6
11200693	Ø 06 mm avorio	ml	300	6



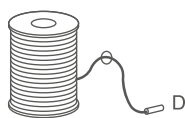

Monofilo di polietilene

11.20 Corda elastica su rotolo
Ø 8 mm

Codice	Prodotto	U.m.	Conf.	D
11200805	Ø 8 bianca	ml	50	8
11200815	Ø 8 blu	ml	50	8
11200825	Ø 8 gialla	ml	50	8
11200835	Ø 8 grigia	ml	50	8
11200845	Ø 8 nera	ml	50	8
11200855	Ø 8 rossa	ml	50	8
11200865	Ø 8 verde	ml	50	8
11200875	Ø 8 avorio	ml	50	8
11200885	Ø 8 verde militare	ml	50	8
11200801	Ø 8 bianca	ml	100	8
11200811	Ø 8 blu	ml	100	8
11200821	Ø 8 gialla	ml	100	8
11200831	Ø 8 grigia	ml	100	8
11200841	Ø 8 nera	ml	100	8
11200851	Ø 8 rossa	ml	100	8
11200861	Ø 8 verde	ml	100	8
11200871	Ø 8 avorio	ml	100	8
11200881	Ø 8 verde militare	ml	100	8
11200802	Ø 8 bianca	ml	200	8
11200812	Ø 8 blu	ml	200	8
11200822	Ø 8 gialla	ml	200	8
11200832	Ø 8 grigia	ml	200	8
11200842	Ø 8 nera	ml	200	8
11200852	Ø 8 rossa	ml	200	8
11200862	Ø 8 verde	ml	200	8
11200872	Ø 8 avorio	ml	200	8
11200882	Ø 8 verde militare	ml	200	8



undici

→ cavi tir, corde elastiche e trecce

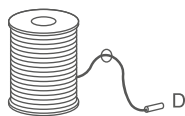

11



Monofilo di polietilene

11.20 Corda elastica su rotolo Ø 10-12-14 mm

Codice	Prodotto	U.m.	Conf.	D
112010051	Ø 10 bianca	ml	100	10
112010151	Ø 10 blu	ml	100	10
112010251	Ø 10 gialla	ml	100	10
112010351	Ø 10 grigia	ml	100	10
112010451	Ø 10 nera	ml	100	10
112010551	Ø 10 rossa	ml	100	10
112010651	Ø 10 verde	ml	100	10
112010751	Ø 10 avorio	ml	100	10
11201200	Ø 12 bianca	ml	100	12
11201210	Ø 12 blu	ml	100	12
11201220	Ø 12 gialla	ml	100	12
11201230	Ø 12 grigia	ml	100	12
11201240	Ø 12 nera	ml	100	12
11201250	Ø 12 rossa	ml	100	12
11201260	Ø 12 verde	ml	100	12
11201400	Ø 14 bianca	ml	100	14
11201410	Ø 14 blu	ml	100	14
11201430	Ø 14 grigia	ml	100	14
11201440	Ø 14 nera	ml	100	14
11201460	Ø 14 verde	ml	100	14

A richiesta corda elastica diam. superiori a 14 mm



undici

→ cavi tir, corde elastiche e trecce

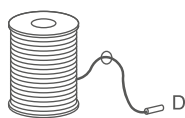

11



"S" multibava
di polipropilene

11.20 Corda elastica multibava su rotolo Solo su richiesta

Codice	Prodotto	U.m.	Conf.	D
11200801S	Ø 8 bianca con riga nera	ml	100	8
11200811S	Ø 8 blu con riga nera	ml	100	8
11200831S	Ø 8 grigia con riga nera	ml	100	8
11200841S	Ø 8 nera	ml	100	8
11200851S	Ø 8 rossa con riga nera	ml	100	8
11200861S	Ø 8 verde con riga nera	ml	100	8
11200802S	Ø 8 bianca con riga nera	ml	200	8
11200812S	Ø 8 blu con riga nera	ml	200	8
11200832S	Ø 8 grigia con riga nera	ml	200	8
11200842S	Ø 8 nera	ml	200	8
11200852S	Ø 8 rossa con riga nera	ml	200	8
11200862S	Ø 8 verde con riga nera	ml	200	8



Poliestere
Nautico

11.20 Corda elastica nautica su rotolo

Codice	Prodotto	U.m.	Conf.	D
11200301NB	Ø 03 mm bianca riga blu	ml	100	3
11200401NB	Ø 04 mm bianca riga blu	ml	100	4
11200501NB	Ø 05 mm bianca riga blu	ml	100	5
11200601NB	Ø 06 mm bianca riga blu	ml	100	6
11200801NB	Ø 08 mm bianca riga blu	ml	100	8
11200602N	Ø 06 mm bianca tinta unita	ml	200	6
11200802N	Ø 08 mm bianca tinta unita	ml	200	8
11201005N	Ø 10 mm bianca tinta unita	ml	150	10

A richiesta altri diametri



undici

→ cavi tir, corde elastiche e trecce

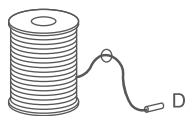

11

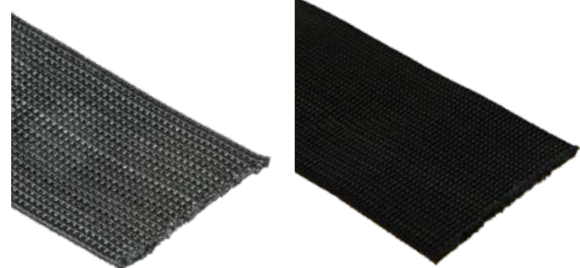

A

B

11.30 Cinghia elastica per tappezzeria

Codice	Prodotto	U.m.	Conf.	D
11301050	top mm 50 nero allungamento 35%	A	ml	100 50
11301060	top mm 60 nero allungamento 35%	B	ml	100 60



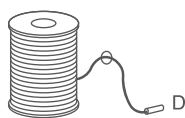

11.40 Treccia vela poliestere Iper

Codice	Prodotto	U.m.	Conf.	L	D	gr/mt	C.R.
11400400	Ø 04 bianca	kg	9	500	4	18	150
11400500	Ø 05 bianca	kg	9	350	5	25	220
11400600	Ø 06 bianca	kg	10	300	6	33	360
11400800	Ø 08 bianca	kg	18	300	8	60	680
11401000	Ø 10 bianca	kg	17	200	10	85	960
11401200	Ø 12 bianca	kg	30	250	12	120	1100
11401400	Ø 14 bianca	kg	30	200	14	155	1300

C.R. Carico di rottura (Kg) teorico

A richiesta con segnalino rosso e blu / A richiesta altri colori



11.40 Treccia vela poliestere H.T. Super

Codice	Prodotto	U.m.	Conf.	L	D	gr/mt	C.R.
11400300	Ø 3 bianca	kg	9	900	3	10	165
11400400B	Ø 4 bianca	kg	3	200	4	15	245
11400500B	Ø 5 bianca	kg	5	200	5	23	380
11400600B	Ø 6 bianca	kg	6	200	6	30	470
11400800B	Ø 8 bianca	kg	10	200	8	50	1120
11401000B	Ø 10 bianca	kg	15	200	10	75	1400
11401200B	Ø 12 bianca	kg	23	200	12	115	2000
11401400B	Ø 14 bianca	kg	28	200	14	140	2800
11401600	Ø 16 bianca	kg	20	100	16	195	3500
11401800	Ø 18 bianca	kg	24	100	18	235	3900
11402000	Ø 20 bianca	kg	28	100	20	285	4400
11402200	Ø 22 bianca	kg	33	100	22	335	5200
11402400	Ø 24 bianca	kg	39	100	24	390	6300

C.R. Carico di rottura (Kg) teorico

A richiesta con segnalino rosso e blu / A richiesta altri colori



undici

→ cavi tir, corde elastiche e trecce

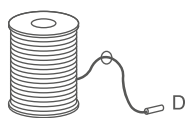

11



11.42 Treccia vela piatta poliestere alta tenacità

Codice	Prodotto	U.m.	Conf.	L	gr/mt
11420604	Ø 06 nera	kg	9	500	18
11420800	Ø 08 bianca	kg	12	600	20
11420804	Ø 08 nera	kg	12	600	20
11420806	Ø 08 verde militare	kg	12	600	20
11421000	Ø 10 bianca	kg	16	600	27
11421004	Ø 10 nera	kg	16	600	27
11421006	Ø 10 verde militare	kg	16	600	27



11.44 Corda liscia ritorta poliestere 3 legnoli

Codice	Prodotto	U.m.	Conf.	L	D	gr/mt
11440604	Ø 06 nera	kg	6	200	6	30
11440800	Ø 08 bianca	kg	10	200	8	51
11440804	Ø 08 nera	kg	10	200	8	51
11441000	Ø 10 bianca	kg	14	200	8	51
11441004	Ø 10 nera	kg	14	200	10	71
11441204	Ø 12 nera	kg	23	200	12	116
11441404	Ø 14 nera	kg	25	200	14	135
11441604	Ø 16 nera	kg	20	100	16	185



11.45 Trecce speciali (solo a richiesta)

Codice	Prodotto	U.m.	Conf.
1145815000	treccia statica per speleologia	ml	a richiesta
1145830000	treccia Kelafire antincendio	ml	a richiesta
1145340000	doppia treccia Kelaplam	ml	a richiesta
1145820000	Dynaprotect	ml	a richiesta
1145335000	doppia treccia Dynaplam	ml	a richiesta
1145714000	rafforzino in nylon	ml	a richiesta

Tutti i dettagli nella sez.45



undici

→ cavi tir, corde elastiche e trecce

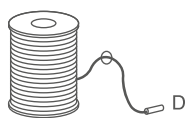

11



11.58 Treccia Riloga polipropilene

Codice	Prodotto	U.m.	Conf.	D
11580300	Ø 03 bianca	mt	500	3
11580304	Ø 03 nera	mt	500	3



11.58 Treccia Veneziana polipropilene

Codice	Prodotto	U.m.	Conf.	D
11580305	Ø 03 bianca	mt	500	3

A richiesta i seguenti colori: verde, giallo, arancio, rosso, bordeaux, blu, azzurro, testa di moro, beige, grigio, nero



11.59 Desmopan PVC elasticizzato

Codice	Prodotto	U.m.	Conf.	D
11590700	Ø 07 pieno	ml	150	7
11590701	Ø 07 vuoto con foro	ml	200	7



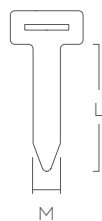

05.03 Cinturino pvc

Codice	Prodotto	U.m.	Conf.	L	M
05030201	cinturino pvc telato cm 12	nr	100	120	16
05030203	cinturino pvc cm 12 verde militare	nr	100	120	16

Per occhiello mm 27 x 8

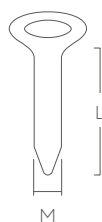

05.03 Cinturino pvc

Codice	Prodotto	U.m.	Conf.	L	M
05030202	mm 42 x 22 grigio	nr	100	120	26
05030203	mm 42 x 22 bianco	nr	100	120	26
05030204	mm 42 x 22 beige	nr	100	120	26

Per occhiello mm 40 x 20



13.45 Cinghia TIR pvc spessore mm 3

Codice	Prodotto	U.m.	Conf.	M
13450015	mm 15	ml	50	15
13450018	mm 18	ml	50	18
13450020	mm 20	ml	50	20
13450022	mm 22	ml	50	22
13450024	mm 24	ml	50	24

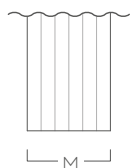
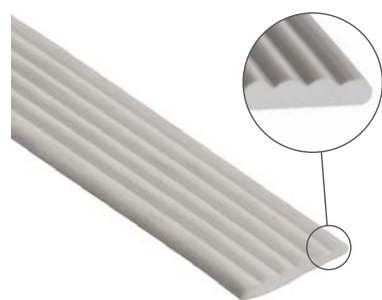

13.45 Cinghia pvc spessore mm 3

Codice	Prodotto	U.m.	Conf.	M
13450002	mm 22 rigata	ml	150	22





13.01 Cappette pvc

Codice	Prodotto	U.m.	Conf.	L	M
13011000	CF 10 fibbia singola col. grigio	nr	100	10	20

Disponibilità colori bianco e avorio



Codice	Prodotto	U.m.	Conf.	L	M
13011000N	CF 10 fibbia singola col. nero	nr	100	10	20



Codice	Prodotto	U.m.	Conf.	L	M
13011000R	CF 10 fibbia doppia col. grigio	nr	100	10	20

Disponibilità colori bianco e avorio

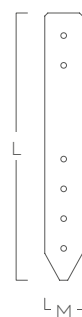

13.01 Punte pvc

Codice	Prodotto	U.m.	Conf.	L	M
13012000	cm 20 col. grigio	nr	100	20	20
13012500	cm 25 col. grigio	nr	100	25	20
13013000	cm 30 col. grigio	nr	100	30	20
13014000	cm 40 col. grigio	nr	100	40	20
13015000	cm 50 col. grigio	nr	100	50	20
13016000	cm 60 col. grigio	nr	100	60	20

Disponibilità colori bianco e avorio

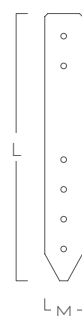

Codice	Prodotto	U.m.	Conf.	L	M
13013000N	cm 30 col. nero	nr	100	30	20
13017000N	cm 70 col. nero	nr	100	70	20

A richiesta altre misure





13.03 Cinturino pvc

Codice	Prodotto	U.m.	Conf.	L	M
13032000	cm 20 col. grigio	nr	100	20	20
13032500	cm 25 col. grigio	nr	100	25	20
13033000	cm 30 col. grigio	nr	100	30	20
13033500	cm 35 col. grigio	nr	100	35	20
13034000	cm 40 col. grigio	nr	100	40	20
13035000	cm 50 col. grigio	nr	100	50	20
13036000	cm 60 col. grigio	nr	100	60	20
13037000	cm 70 col. grigio	nr	100	70	20
13038000	cm 80 col. grigio	nr	100	80	20
13031000	cm 100 col. grigio	nr	100	100	20

Disponibilità con fibbia doppia / disponibilità colori bianco, avorio e nero

A richiesta altre misure



13.04 Asole corda piatta poliester

Codice	Prodotto	U.m.	Conf.	L
13042500	cm 25	nr	100	25
13044500	cm 45	nr	100	45
13045500	cm 55	nr	100	55

Disponibilità colori tappi bianco/nero/verde militare

A richiesta altre misure
Adatte per occhiello mm 20





13.05 Cappette pvc

Codice	Prodotto	U.m.	Conf.	L	M
13051000	cappette pvc doppio strato con protezione	nr	100	10	20



Codice	Prodotto	U.m.	Conf.	L	M
13052300	cinturino pvc per arrotolamento cm 30	nr	100	30	20
13052400	cinturino pvc per arrotolamento cm 40	nr	100	40	20
13052500	cinturino pvc per arrotolamento cm 50	nr	100	50	20
13052600	cinturino pvc per arrotolamento cm 60	nr	100	60	20

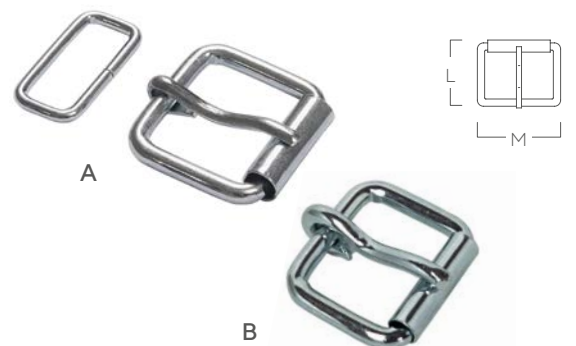

13.35 Fibbie cinturini

Codice	Prodotto	U.m.	Conf.	L	M*
13350100	f.z. mm 21 singola con passante	A nr	250	25	21
13350105	f.z. mm 25 singola con passante	A nr	250	27,5	25
13350128	f.z. mm 28 singola	B nr	250	34	28
133501000N	o.n. mm 20 singola con passante	A nr	1000	25	20



Codice	Prodotto	U.m.	Conf.	L	M*
13350221	f.z. mm 22 doppia	nr	250	38	22
13350225	f.z. mm 25 doppia	nr	250	40	25



Codice	Prodotto	U.m.	Conf.	L	M*
13350300	f.z. piatta	nr	100	31	20

*Passaggio nastro



Codice	Prodotto	U.m.	Conf.	L	M*
13350450FZ	f.z. scorrevole filo 4	nr	100	20	50

*Passaggio nastro





13.26 Cinturino poliestere con fibbia zama

Codice	Prodotto	U.m.	Conf.	L	M
13260550	mm 25 cm 55 bianco	nr	100	55	25
13260700	mm 25 cm 70 bianco	nr	100	70	25
13260800	mm 25 cm 80 bianco	nr	100	80	25
13261000	mm 25 cm 100 bianco	nr	100	100	25

A richiesta altre misure / colori



13.35 Fibbie zama

Codice	Prodotto	U.m.	Conf.	L	M*	B.L.	L.C.
13354020	mm 20	nr	100	34	20	180	90
13354025	mm 25	nr	100	44	25	250	125
13354035	mm 35	nr	100	60	35	700	400
13354050	mm 50	nr	100	78	55	900	450

* Passaggio nastro

B.L. Breaking Load · Carico di rottura
L.C. Lashing capacity · Carico di lavoro



La zama è una lega di zinco unita a piccole percentuali di alluminio, magnesio e rame.



13.35 Pinzetta zama

Codice	Prodotto	U.m.	Conf.	L	M*
13354126	mm 26 pinzetta	nr	100	60	26

* Passaggio nastro



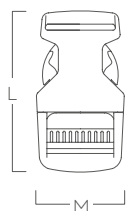

13.35 Fibbie a scatto nylon

Codice	Prodotto	U.m.	Conf.	L	M*
13350020	mm 20 nero	nr	100	55	20
13350025	mm 25 nero	nr	100	67	25
13350030	mm 30 nero	nr	100	70	30
13350035	mm 35 nero	nr	100	70	35
13350040	mm 40 nero	nr	100	78	40
13350050	mm 50 nero	nr	100	95	50

* Passaggio nastro

Disponibili anche in bianco

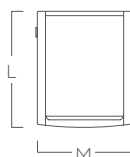

13.35 Fibbie AISI 316

Codice	Prodotto	U.m.	Conf.	L	M*
13354025AI	mm 25	nr	100	50	25

* Passaggio nastro

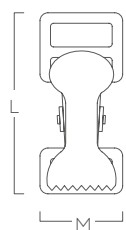

13.35 Fibbie AISI 316

Codice	Prodotto	U.m.	Conf.	L	M*
13354126AI	mm 26 pinzetta	nr	100	60	26

* Passaggio nastro

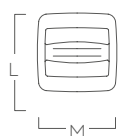

13.38 Fibbie AISI 304

Codice	Prodotto	U.m.	Conf.	L	M*
13382500AI	autobloccante con passante	nr	100	33	25
13384000AI	autobloccante con passante	nr	100	-	40

* Passaggio nastro



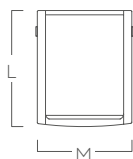

13.35 Fibbie dentate nylon

Codice	Prodotto	U.m.	Conf.	L	M*
13353000	mm 25 bianca	nr	100	44	25
13353004	mm 25 nera	nr	100	44	25

* Passaggio nastro | A richiesta mm 20-30-40



13.36 Passanti doppi nylon

Codice	Prodotto	U.m.	Conf.	L	M*
13362024	mm 20 nero	nr	100	37	20
13362524	mm 25 nero	nr	100	40	25
13363024	mm 30 nero	nr	100	41	30
13364024	mm 40 nero	nr	100	50	40

* Passaggio nastro | A richiesta colore bianco



13.36 Passanti singoli nylon

Codice	Prodotto	U.m.	Conf.	L	M*
13362014	mm 20 nero	nr	100	22	20
13362514	mm 25 nero	nr	100	26	25
13363014	mm 30 nero	nr	100	28	30
13364014	mm 40 nero	nr	100	37	40
13365014	mm 50 nero	nr	100	36	50

* Passaggio nastro | A richiesta colore bianco



13.39 Rettangolo nylon

Codice	Prodotto	U.m.	Conf.	L	M*
13392504	mm 25 nero	nr	100	12	25
13394004	mm 40 nero	nr	100	18	24

* Passaggio nastro



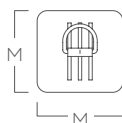

13.40 Rinforzi tenditelone con anello f.z.

Codice	Prodotto	U.m.	Conf.	L	M*
13400200	bianco	nr	250	12,6	12,0
13400201	blu	nr	250	12,6	12,0
13400202	giallo	nr	250	12,6	12,0
13400203	grigio	nr	250	12,6	12,0
13400205	rosso	nr	250	12,6	12,0
13400206	verde	nr	250	12,6	12,0

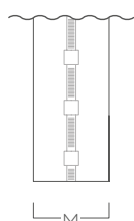
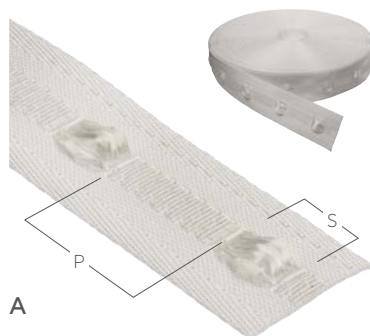

50.10 Cinghie saldabili pvc con asole

Codice	Prodotto	U.m.	Conf.	M	KG	P	S	
50105050	mm 50 *	B	ml	100	50	1.000	150	30
50107000	mm 70 in esaurimento	A	ml	100	70	1.400	50	25

* a richiesta mm 70



B

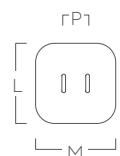

13.40 Rinforzo quadrato

Codice	Prodotto	U.m.	Conf.	L	M	P
13400001	quadrato col. bianco 900 gr	nr	100	10,6	10,6	3,4
13400002	quadrato col. nero 900 gr	nr	100	10,6	10,6	3,4
13400003	quadrato col. avorio 900 gr	nr	100	10,6	10,6	3,4
13400004	quadrato col. bianco 1200 gr	nr	100	10,6	10,6	3,4





13.40 Rinforzo rotondo

Codice	Prodotto	U.m.	Conf.	L
13400005	rotondo col. bianco 900 gr	nr	100	11,0

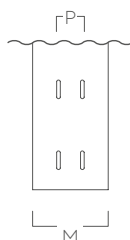

13.40 Rinforzi su rotolo

Codice	Prodotto	U.m.	Conf.	L	M	P
13400070	900gr col. bianco	ml	100	100	70	2,10
13400100	900gr col. bianco	ml	100	100	100	2,10
13400102	900gr col. grigio	ml	58	100	100	2,10
13400104	900gr col. avorio RAL1015	ml	58	100	100	2,10
13400106	900gr col. verde	ml	58	100	100	2,10
13400120	1200gr col. bianco	ml	100	100	100	2,10

Altri colori su richiesta

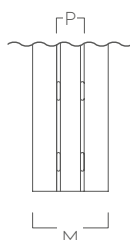

13.42 Cinghia saldabile asolata

Codice	Prodotto	U.m.	Conf.	L	M	P
13420100	col. bianco	ml	100	100	98	3
13420106	col. verde militare	ml	100	100	98	3

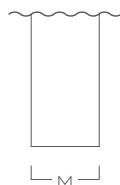

13.45 Cinghie in pvc

Codice	Prodotto	U.m.	Conf.	M
134510AB	ab 20 mm 100 per rinforzi · spessore mm 2,6	ml	100	100





13.50 Nastri in polipropilene

Codice	Prodotto	U.m.	Conf.	M
13501500	mm 15 bianco	ml	100	15
13501504	mm 15 nero	ml	100	15
13502000	mm 20 bianco	ml	100	20
13502003	mm 20 grigio	ml	100	20
13502500	mm 25 bianco	ml	100	25
13502502	mm 25 giallo	ml	100	25
13502504	mm 25 nero	ml	100	25
13503500	mm 35 bianco	ml	100	35
13503502	mm 35 giallo	ml	100	35
13503504	mm 35 nero	ml	100	35
13505000	mm 50 bianco	ml	100	50
13505004	mm 50 nero	ml	100	50

A richiesta: altre misure e colori



13.51 Nastri spigatela

Codice	Prodotto	U.m.	Conf.	M
13514000P	spigatela mm 40 poliestere	ml	100	40
13515000P	spigatela mm 50 poliestere	ml	100	50
13516000P	spigatela mm 60 poliestere	ml	100	60



13.55 Nastri poliestere canetè

Codice	Prodotto	U.m.	Conf.	M
13552010	mm 20 bianco	ml	100	20
13552500	mm 25 bianco	ml	100	25
13553010	mm 30 bianco	ml	100	30
13555000	mm 50 bianco	ml	100	50

A richiesta altri colori



13.02 Ganci bandiere

Codice	Prodotto	U.m.	Conf.	M	L
130270NY	bianco	nr	5000	47	25
130274NY	nero	nr	5000	47	25
130270PL	gancio bianco con nastro cm 10	nr	4000		



13.65 Nastri poliestere a bande

Codice	Prodotto	U.m.	Conf.	M
13654500	mm 45 kg 1200 bianco a bande	A	ml	100 45
13655000	mm 50 kg 2800 bianco a bande	A	ml	100 50
1365500TF	mm 50 kg 2800 bianco a bande termofissato	B	ml	100 50

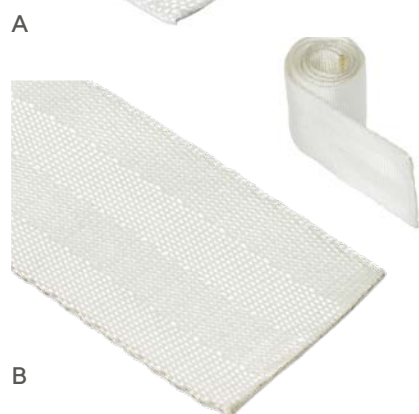



13.65 Nastri cintura sicurezza

Codice	Prodotto	U.m.	Conf.	M	DaN
13653904	mm 38 nero	ml	100	38	1.300
13655001	mm 47 blu	ml	100	47	2.650
13655002	mm 50 bianco	ml	100	50	2.650
13655004	mm 47 nero	ml	100	47	2.650
13655005	mm 47 rosso	ml	100	47	2.650
13655006	mm 47 grigio	ml	100	47	2.650
13655007	mm 47 avorio	ml	100	47	2.650



13.66 Nastri poliestere HT

Codice	Prodotto	U.m.	Conf.	M
13660050	mm 50 bianco per bordare	ml	200	50
13660080	mm 80 bianco per bordare	ml	200	80
13660100	mm 100 bianco per bordare	ml	200	100



13.67 Nastri spigati multifibra di poliestere HT Per bordature vele

Codice	Prodotto	U.m.	Conf.	M
13670025	mm 25 kg 800 bianco	ml	100	25
13670030	mm 30 kg 1.000 bianco	ml	100	30
13670040	mm 40 kg 1.300 bianco	ml	100	40
13670050	mm 50 kg 2.300 bianco	ml	100	50
13670100	mm 100 kg 15.000 bianco	ml	100	100

A richiesta colori: Nero, Blu, Grigio, Bordeaux

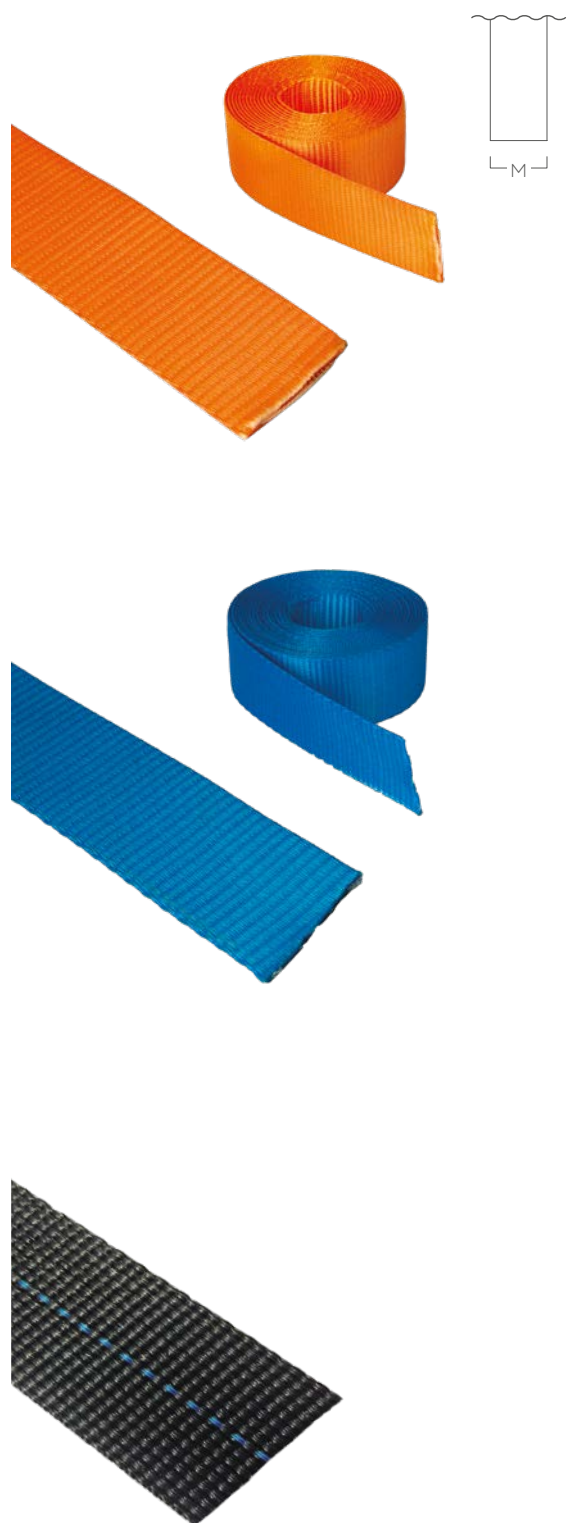

13.70 Nastri poliestere per ancoraggio

Codice	Prodotto	U.m.	Conf.	M
13700604	mm 6 nero	ml	100	6
13701500	mm 15 bianco kg 500	ml	100	15
13701504	mm 15 nero kg 500	ml	100	15
13702000	mm 20 kg 700 bianco	ml	100	20
13702004	mm 20 kg 700 nero	ml	100	20
13702500	mm 25 kg 800 bianco	ml	100	25
13702501	mm 25 kg 1200 bianco	ml	100	25
13702504	mm 25 kg 1200 nero	ml	100	25
13702505	mm 25 kg 1300 bianco riga rossa	ml	100	25
13702510	mm 25 kg 1200 blu	ml	100	25
13702520	mm 25 kg 1200 giallo	ml	100	25
13702530	mm 25 kg 1200 grigio	ml	100	25
13702550	mm 25 kg 1200 rosso	ml	100	25
13702560	mm 25 kg 1200 verde	ml	100	25
13702565	mm 25 kg 1200 verde militare	ml	100	25
13702580	mm 25 kg 1200 arancio	ml	100	25
13703000	mm 30 kg 2500 bianco	ml	100	30
13703004	mm 30 kg 2500 nero	ml	100	30
13703500	mm 35 kg 3200 bianco	ml	100	35
13703505	mm 35 kg 3300 bianco con riga rossa	ml	100	35
13703510	mm 35 kg 3200 blu	ml	100	35
13703530	mm 35 kg 3200 grigio	ml	100	35
13703540	mm 35 kg 3200 nero	ml	100	35
13703550	mm 35 kg 3200 rosso	ml	100	35
13703560	mm 35 kg 3200 verde militare	ml	100	35
13703580	mm 35 kg 3200 arancio	ml	100	35
13704504	mm 45 kg 2200 nero prontocar	ml	100	45
13704504R	mm 45 kg 2200 nero riga blu prontocar	ml	100	45
13704503	mm 45 kg 2200 grigio prontocar	ml	100	45



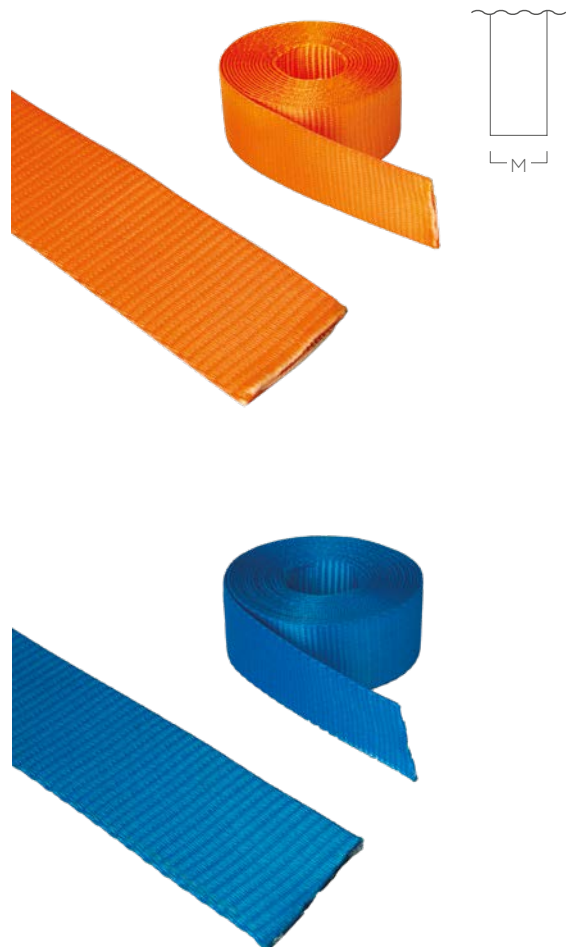

13.70 Nastri poliestere per ancoraggio

Codice	Prodotto	U.m.	Conf.	M
13705000	mm 50 kg 5000 bianco	ml	100	50
13705005	mm 50 kg 5000 bianco con riga rossa	ml	100	50
13705007	mm 50 kg 7500 blu trattato <4%	ml	100	50
13705010	mm 50 kg 5000 blu	ml	100	50
13705020	mm 50 kg 5000 giallo	ml	100	50
13705030	mm 50 kg 5000 grigio	ml	100	50
13705040	mm 50 kg 5000 nero	ml	100	50
13705050	mm 50 kg 5000 rosso	ml	100	50
13705061	mm 50 kg 5000 verde	ml	100	50
13705065	mm 50 kg 5000 verde militare	ml	100	50
13705070	mm 50 kg 5000 marrone	ml	100	50
13705080	mm 50 kg 5000 arancio	ml	100	50
13705086	mm 50 kg 6000 arancio con riga nera	ml	100	50
13705090	mm 50 kg 6000 blu	ml	100	50
13705011	mm 50 kg 7500 blu con riga nera	ml	100	50
13705051	mm 50 kg 7500 rosso con riga nera	ml	100	50



13.70 Nastri poliestere fluorescenti per ancoraggio

Codice	Prodotto	U.m.	Conf.	M
13702520F	mm 25 kg 1200 giallo fluo	ml	100	25
13702580F	mm 25 kg 1200 arancio fluo	ml	100	25
13703580F	mm 35 kg 3500 arancio fluo	ml	100	35



13.75 Nastri poliestere per sollevamento

Codice	Prodotto	U.m.	Conf.	M
13750050	mm 50 kg 7500 bianco	ml	100	50
13750060	mm 60 kg 8500 bianco	ml	100	60
13750075	mm 75 kg 11250 bianco	ml	100	75
13750100	mm 100 kg 15000 bianco	ml	100	100



45.70 Nastri poliestere per sollevamento (tipo brache)

Codice	Prodotto	U.m.	Conf.	M
45700500	mm 50 kg 4500 viola	ml	100	50
45700600	mm 60 kg 9000 verde	ml	100	60
45700900	mm 90 kg 13500 giallo	ml	100	90
45701200	mm 120 kg 18000 grigio	ml	100	120
45701500	mm 150 kg 22500 rosso	ml	100	150
45701800	mm 180 kg 30000 marrone	ml	100	180
45702400	mm 240 kg 40000 blu	ml	100	240
45703000	mm 300 kg 50000 arancio	ml	100	300





13.46 Stamoid Edge Ferrari

Codice	Prodotto
13462000	20 mm bianco rotoli da mt 50
13462500	25 mm bianco rotoli da mt 50

DESCRIZIONE:

Vero e proprio sbieco tagliato a 45° nel tessuto spalmato Serge Ferrari Stamoid Light. Risvolti su ogni lato piegato a caldo.

APPLICAZIONE:

Rifinitura dei bordi delle coperture, cappottine, bimini...possibilità di combinazioni estetiche giocando con i colori. Protezione laterale del bordo tessuto contro l'abrasione e la penetrazione dell'umidità.

PRINCIPALI CARATTERISTICHE:

Estremamente flessibile e maneggevole per adattarsi a tutte le forme, specialmente quelle curve. Alta resistenza ai raggi UV. Trattamento antimuffa. Colori abbinati alla gamma S. Ferrari Yachting Protection. Facile da pulire.

SPESSORE 20 mm



B20-10309

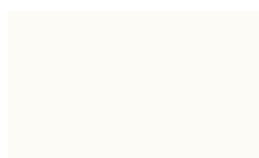

B20-03244

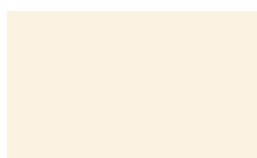

B20-10081



B20-01897



B20-20217



B20-20165

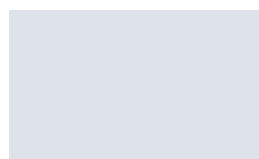

B20-10001



B20-20218



B20-20166



B20-10235



B20-00002

SPESSORE 25 mm



B25-10309

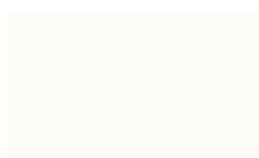

B25-03244

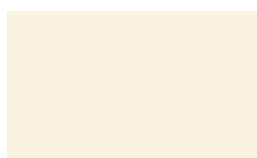

B20-10081



B25-01897



B25-10001



B25-10235



B25-00002



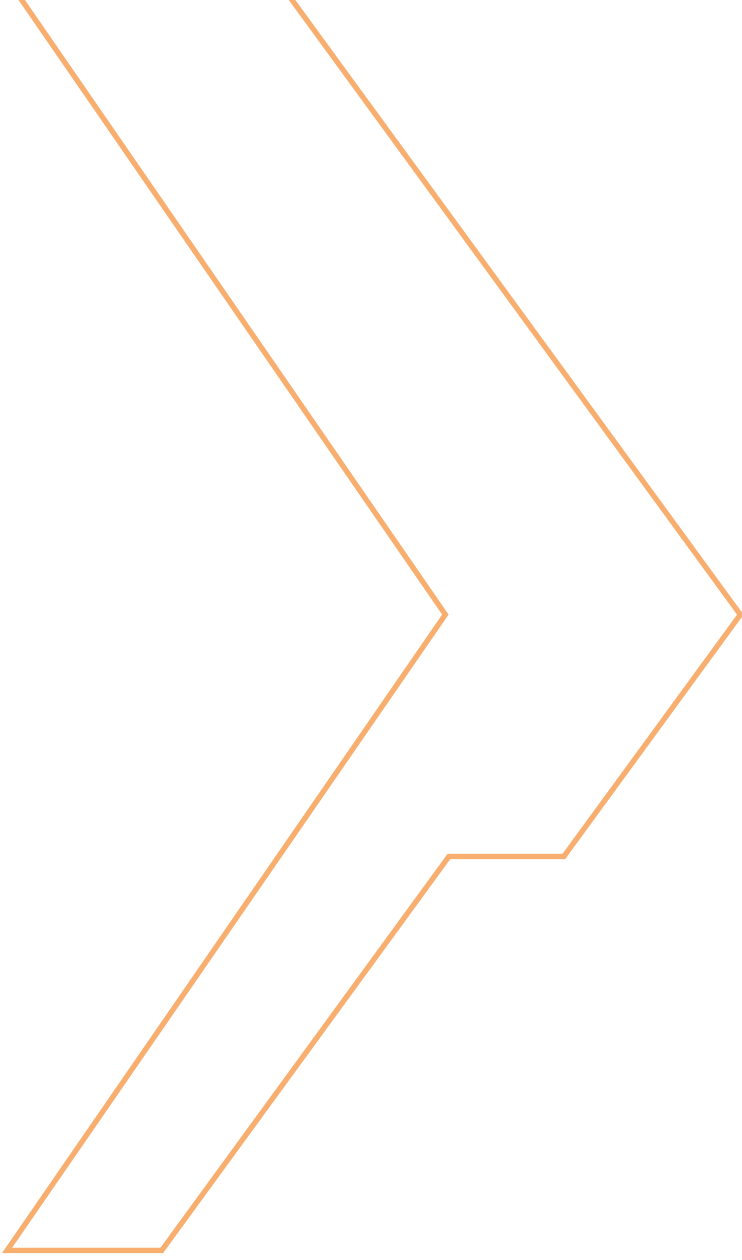

/
QUINDICI

Tenditelo
Elastici



quindici

→ tenditelo elastici

15



15.01 Tenditelo gancio cestello f.z.

Codice	Prodotto	U.m.	Conf.	D	L
15011500	cm 15 bianco	nr	100	6	15
15011504	cm 15 nero	nr	100	6	15
15012000	cm 20 bianco	nr	100	6	20
15012002	cm 20 blu	nr	100	6	20
15012004	cm 20 nero	nr	100	6	20
15012005	cm 20 grigio	nr	100	6	20
15012006	cm 20 verde	nr	100	6	20
15012008	cm 20 rosso	nr	100	6	20
15012500	cm 25 bianco	nr	100	6	25
15012502	cm 25 blu	nr	100	6	25
15012504	cm 25 nero	nr	100	6	25
15012505	cm 25 grigio	nr	100	6	25
15012506	cm 25 verde	nr	100	6	25
15012508	cm 25 rosso	nr	100	6	25
15013000	cm 30 bianco	nr	100	6	30
15013002	cm 30 blu	nr	100	6	30
15013004	cm 30 nero	nr	100	6	30
15013005	cm 30 grigio	nr	100	6	30
15013006	cm 30 verde	nr	100	6	30
15013008	cm 30 rosso	nr	100	6	30
15013500	cm 35 bianco	nr	100	6	35
15013504	cm 35 nero	nr	100	6	35
15014000	cm 40 bianco	nr	100	6	40
15014004	cm 40 nero	nr	100	6	40

A richiesta altre misure



quindici

→ tenditelo elastici

15



15.01 Tenditelo gancio cestello GC f.z.

Codice	Prodotto	U.m.	Conf.	D	L
15012000GC	cm 20 bianco	nr	100	6	20
15012002GC	cm 20 blu	nr	100	6	20
15012004GC	cm 20 nero	nr	100	6	20
15012005GC	cm 20 grigio	nr	100	6	20
15012006GC	cm 20 verde	nr	100	6	20
15012008GC	cm 20 rosso	nr	100	6	20
15012500GC	cm 25 bianco	nr	100	6	25
15012502GC	cm 25 blu	nr	100	6	25
15012504GC	cm 25 nero	nr	100	6	25
15012505GC	cm 25 grigio	nr	100	6	25
15012506GC	cm 25 verde	nr	100	6	25
15012508GC	cm 25 rosso	nr	100	6	25
15013000GC	cm 30 bianco	nr	100	6	30
15013002GC	cm 30 blu	nr	100	6	30
15013004GC	cm 30 nero	nr	100	6	30
15013005GC	cm 30 grigio	nr	100	6	30
15013006GC	cm 30 verde	nr	100	6	30
15013008GC	cm 30 rosso	nr	100	6	30
15013500GC	cm 35 bianco	nr	100	6	35
15013504GC	cm 35 nero	nr	100	6	35
15014000GC	cm 40 bianco	nr	100	6	40
15014004GC	cm 40 nero	nr	100	6	40
15014500GC	cm 45 bianco	nr	100	6	45
15014504GC	cm 45 nero	nr	100	6	45
15015000GC	cm 50 bianco	nr	100	6	50
15015004GC	cm 50 nero	nr	100	6	50
15016000GC	cm 60 bianco	nr	100	6	60
15016004GC	cm 60 nero	nr	100	6	60

Codice	Prodotto	U.m.	Conf.	D	L
15012000GC8	cm 20 bianco	nr	100	8	20
15012500GC8	cm 25 bianco	nr	100	8	25
15013000GC8	cm 30 bianco	nr	100	8	30
15014000GC8	cm 40 bianco	nr	100	8	40
15015000GC8	cm 50 bianco	nr	100	8	50
15016000GC8	cm 60 bianco	nr	100	8	60

A richiesta altri colori e lunghezze



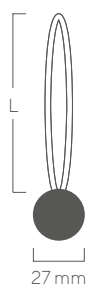

15.03 Tenditelo gancio sfera

Codice	Prodotto	U.m.	Conf.	D	L
15030800N	cm 08-3" corda bianca riga nera / sfera nera	nr	100	6	8
15031500	cm 15-6" corda bianca riga nera / sfera bianca	nr	100	6	15
15031500N	cm 15-6" corda bianca riga nera / sfera nera	nr	100	6	15
15032500N	cm 25-9" corda bianca riga nera / sfera nera	nr	100	6	25



Codice	Prodotto	U.m.	Conf.	D	L
15030804	cm 08-3" corda nera / sfera nera	nr	100	6	8
15031504	cm 15-6" corda nera / sfera nera	nr	100	6	15
15032504	cm 25-9" corda nera / sfera nera	nr	100	6	25



Codice	Prodotto	U.m.	Conf.	D	L
15032500	cm 25-9" corda bianca / sfera bianca	nr	100	6	25



quindici

→ tenditelo elastici

15



15.04 Tenditelo gancio con sicura

Codice	Prodotto	U.m.	Conf.	D	L
15043504	cm 34,5	nr	100	8	34,5
15046004	cm 60	nr	100	8	60

Altre misure a richiesta



15.04 Tenditelo serravele

Codice	Prodotto	U.m.	Conf.	D	L*
15040050	cm 50 clip nera corda nera	nr	100	5	50
15040052	cm 50 clip nera corda bianca	nr	100	5	50
15040052B	cm 50 clip bianca corda bianca	nr	100	5	50

*Lunghezza corda esclusa clip | A richiesta altre misure



Codice	Prodotto	U.m.	Conf.	D*
07095000	Gancio/Clip serravele bianco	nr	100	5
07095004	Gancio/Clip serravele nero	nr	100	5

*Per corda elastica 5mm



15.08 Tiranti

Codice	Prodotto	U.m.	Conf.	D
15080__	articolo su richiesta, corda elastica diam. 6mm	nr	100	6

Lunghezza e colore corda su richiesta



quindici

→ tenditelo elastici

15



15.05 Tenditelo gancio nero
Corda nera · Articoli solo su richiesta

Codice	Prodotto	U.m.	Conf.	D	L
15051304	13 cm	nr	100	6	13
15051804	18 cm	nr	100	6	18
15052004	20 cm	nr	100	6	20
15052504	25 cm	nr	100	6	25



15.05 Tenditelo gancio nero
Corda bianca · Articoli solo su richiesta

Codice	Prodotto	U.m.	Conf.	D	L
15051300	13 cm	nr	100	6	13
15051800	18 cm	nr	100	6	18
15052000	20 cm	nr	100	6	20
15052500	25 cm	nr	100	6	25



15.06 Tenditelo gancio nero
Corda nera · Articoli solo su richiesta

Codice	Prodotto	U.m.	Conf.	D	L
15062504	25 cm	nr	100	8	25



15.07 Tenditelo gancio nylon
Articoli solo su richiesta

Codice	Prodotto	U.m.	Conf.	D	L
15072000	20 cm bianco	nr	100	4	20
15072004	20 cm nero	nr	100	4	20
15073500	35 cm bianco	nr	100	4	35
15073504	35 cm nero	nr	100	4	35



quindici

→ tenditelo elastici

15

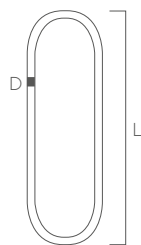
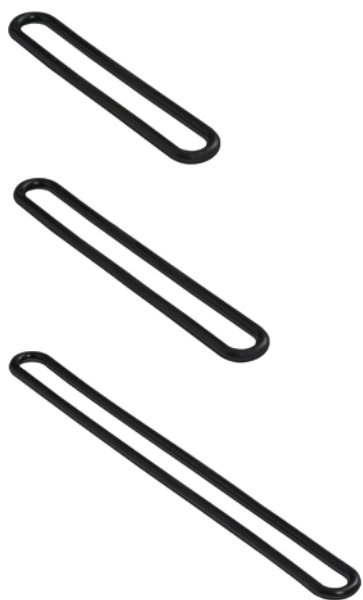

15.10 Tenditelo pura gomma

Codice	Prodotto	U.m.	Conf.	D	L
15102004	cm 20 nero EPDM	nr	100	8	20

Codice	Prodotto	U.m.	Conf.	D	L
15102504	cm 25 nero EPDM	nr	100	8	25

Codice	Prodotto	U.m.	Conf.	D	L
15104004	cm 40 nero EPDM	nr	100	8	40

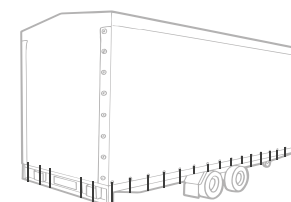
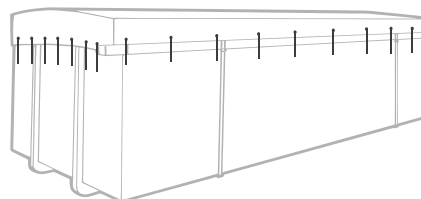
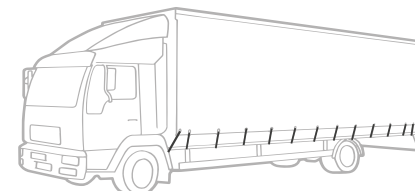
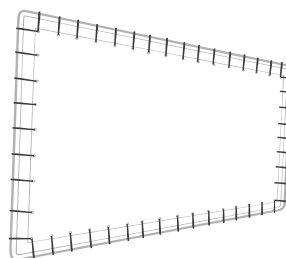

Specifiche tecniche	20 cm	25 cm	40 cm
Composizione	EPDM	EPDM	EPDM
Resistenza alla rottura	± 40 kg	± 40 kg	± 40 kg
Allungamento % a 40 kg	+ 150% (50 cm)	+ 150% (62,5 cm)	+ 150% (100 cm)

DATI NON CERTIFICATI · ARTECA SpA non si assume alcuna responsabilità per l'uso improprio del prodotto

Si consiglia utilizzo con Gancio S 070101FZ



quindici

→ tenditelo elastici

15



15.10 Tenditelo pura gomma

Codice	Prodotto	U.m.	Conf.	D
15106026	regolabile cm 28	nr	100	28

Codice	Prodotto	U.m.	Conf.	D
15106118	'T' cm 18*	nr	100	18
15106125	'T' cm 25*	nr	100	25

* Articoli su richiesta



/
DICIOTTO

Anelli
& Mezzanelli

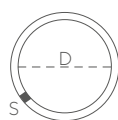

**18.01** Anelli tondi saldati f.z.

Codice	Prodotto	U.m.	Conf.	D	S
18011600	mm 16	nr	100	16	2,2
18012000	mm 21	nr	100	21	3
18012700	mm 27	nr	100	27	3,4
18013000	mm 30	nr	100	30	4,0
18013005	mm 30	nr	100	30	5,0
18013500	mm 35	nr	100	35	4,5
18014000	mm 40	nr	100	40	4,9
18015000	mm 50	nr	100	50	4,9
18015008	mm 50	nr	100	50	8,0
18016000	mm 60	nr	100	60	4,9
18017000	mm 70	nr	100	70	5,0

A richiesta: altre misure

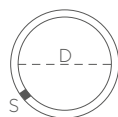
**18.01** Anelli tondi saldati acciaio inox 316

Codice	Prodotto	U.m.	Conf.	D	S
180125AI	mm 25	nr	100	25	5
180135AI	mm 35	nr	100	35	5
180140AI	mm 40	nr	100	40	5
180150AI	mm 50	nr	100	50	5
180160AI	mm 60	nr	100	60	6

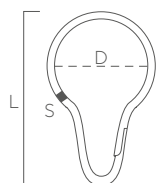

**18.05** Anello a pera f.z.

Codice	Prodotto	U.m.	Conf.	D	L	S
18052000	per tubo mm 20	nr	1000	25	48	2,5
18052500	per tubo mm 25	nr	500	30	57	2,5
18053000	per tubo mm 30	nr	500	35	72	2,5

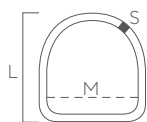
**18.10** Mezzanelli saldati f.z.

Codice	Prodotto	U.m.	Conf.	gr/pz	L	M	S
181020FZ	mm 20	nr	100	7,5	25	20	4
181025FZ	mm 25	nr	100	11,5	28	25	4
181030FZ	mm 30	nr	100	18,0	39	30	5
181035FZS	mm 35	nr	100	28,5	42	35	6
181040FZ	mm 40	nr	100	41,0	45	40	6
181050FZ	mm 50	nr	100	63,0	58	50	7

A richiesta: altre misure

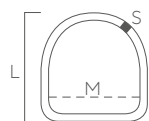
**18.10** Mezzanelli non saldati f.z.

Codice	Prodotto	U.m.	Conf.	L	M	S
1810203FZ	mm 20	nr	100	22	20	3
181035FZ	mm 35	nr	100	42	35	6

**18.10** Mezzanelli acciaio inox 304

Codice	Prodotto	U.m.	Conf.	L	M	S
181025AI	mm 25	nr	100	30	25	5
181035AI	mm 35	nr	100	42	35	5
181040AI	mm 40	nr	100	45	40	5,5
181048AI	mm 48	nr	100	60	48	6
181050AI	mm 50	nr	100	62	50	6

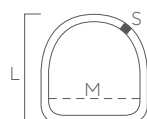
**18.12** Mezzanelli nylon

Codice	Prodotto	U.m.	Conf.	L	M	S
18122504	mm 25 nero	nr	1.000	30	25	5
18123500	mm 35 bianco	nr	1.000	36	35	7
18123504	mm 35 nero	nr	1.000	36	35	7

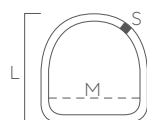
**18.13** Mezzanelli saldati f.z.

Codice	Prodotto	U.m.	Conf.	L	M	S
181330FZS	mm 40 x 30	nr	1.000	30	40	5,0

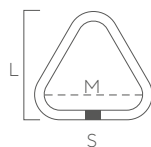

**18.13** Triangolo saldato

Codice	Prodotto	U.m.	Conf.	L	M	S
181340FZ	mm 36x32x5 f.z.	nr	100	32	36	5
181340AI	mm 36x32x5 acciaio inox 304	nr	100	32	36	5
181360FZ	mm 50x42x6 f.z.	nr	100	42	50	6

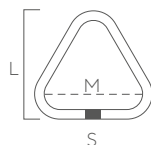
**18.14** Triangolo saldato

Codice	Prodotto	U.m.	Conf.	L	M	S
181460AI	con asola acciaio inox 316	nr	100	53	54	6

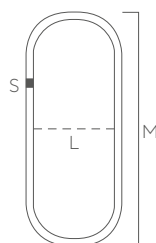
**18.15** Anelli ovali f.z.

Codice	Prodotto	U.m.	Conf.	L	M	S
18150005	mm 50 *	nr	100	20	50	5,0
18150010	mm 100	nr	100	23	100	5,0

* Utilizzato per la produzione cinghiolo 32.80

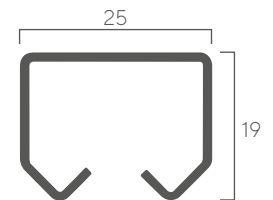
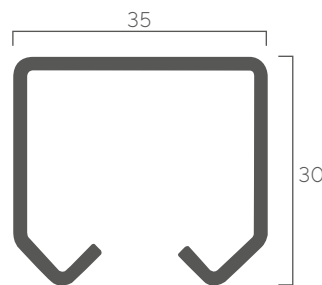
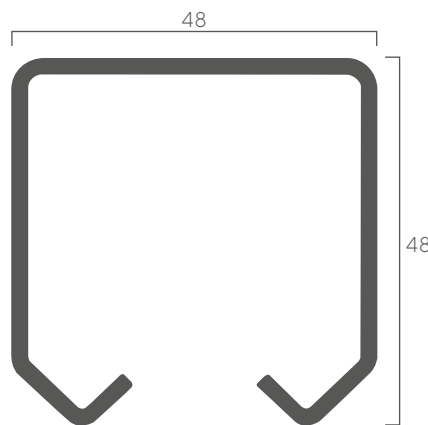
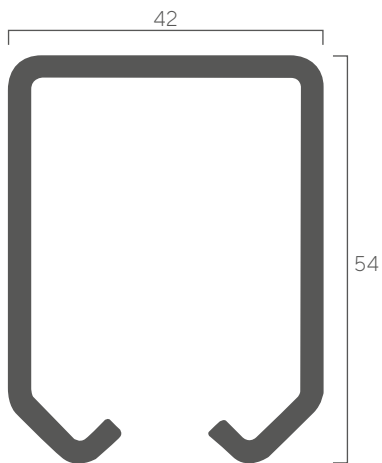
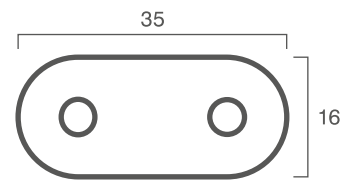
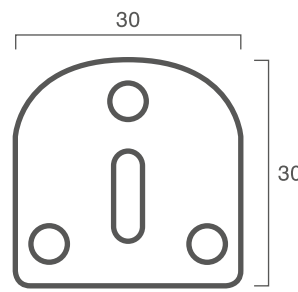
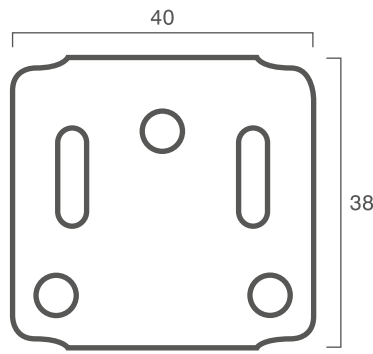
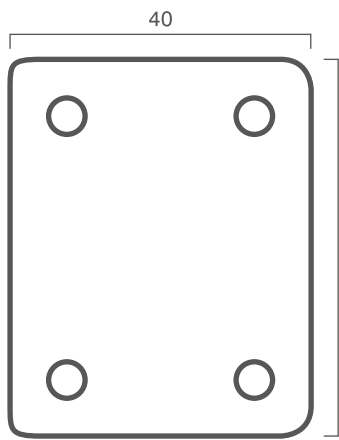

/
VENTICINQUE

Carrucole,
guide e accessori



Binari, carrelli, ruote ø 15

Il sistema

Questa linea comprende binari e accessori pensati per realizzare sistemi di porte scorrevoli con ante leggere in legno, alluminio, pvc e cristal.

Tecnica

Binari in acciaio e carrelli con ruote a completa corona di sfere disponibili in acciaio inox e nylon per uno scorrimento fluido e silenzioso.

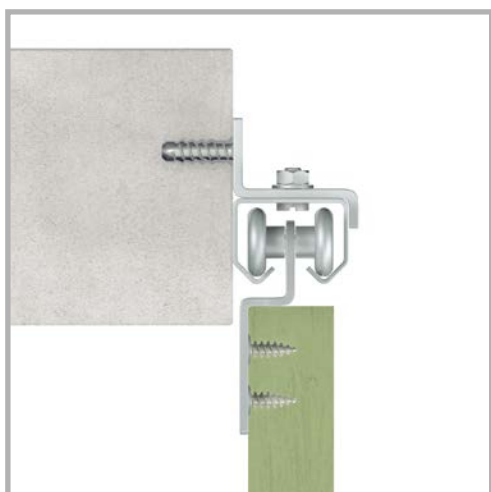

venticinque

→ carrucole, guide e accessori

∅ 15

25

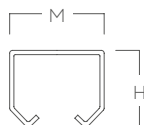

25.19 Binari per carrucole 25 kg portata max

Codice	Prodotto	U.m.	Conf.	M	L	H
25191505	acciaio zincato per ruota ∅ 15	nr	5	25	5	19
disponibili anche da mt 4 - mt 6						
25191505AI	acciaio inox 304 per ruota ∅ 15	nr	5	25	5	19
disponibili anche da mt 6						
25191506AA	alluminio anodizzato per ruota ∅ 15	nr	5	25	6	19
25191506AB	alluminio bianco per ruota ∅ 15	nr	5	25	6	19

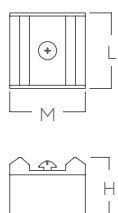

25.19 Paracolpi

Codice	Prodotto	U.m.	Conf.	L	M	H
25210015	∅ 15	nr	100	20	20	15,5

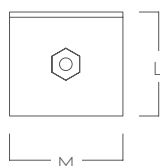

25.21 Staffe f.z. a parete per binari

Codice	Prodotto	U.m.	Conf.	L	M
25210115	∅ 15	nr	50	27,5	30

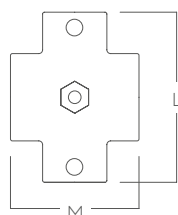

25.21 Staffe f.z. a soffitto per binari

Codice	Prodotto	U.m.	Conf.	L	M
25210215	∅ 15	nr	50	45	34



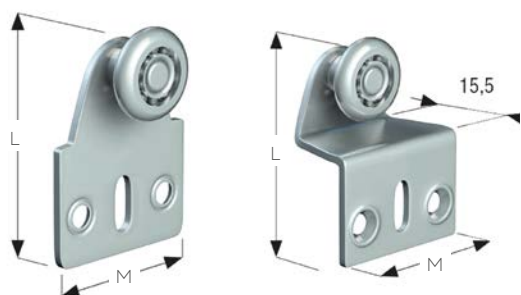

25.01 Carrucole 1 cuscinetto

Codice	Prodotto	U.m.	Conf.	D	L	M
25011500	∅ 15 f.z.	nr	50	15	35,5	28
25011501	∅ 15 f.z. piastra piegata	nr	50	15	33,5	28

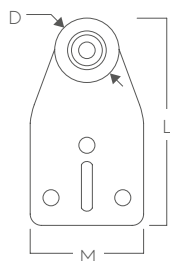

25.02 Carrucole 2 cuscinetti
15 kg portata max

Codice	Prodotto	U.m.	Conf.	D	L	M
25021500	∅ 15 f.z.	nr	50	15	54,5	30
25021500Al304	∅ 15 acciaio inox 304	nr	50	15	54,5	30

Piastra compatibile 070599 RI-RIL

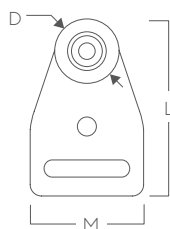

25.02 Carrucola 2 cuscinetti

Codice	Prodotto	U.m.	Conf.	D	L	M
25021503	∅ 15 f.z. con foro e asola interno asola 23,5 mm	nr	100	15	38	30

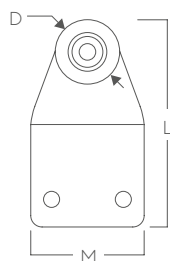

25.02 Carrucole 2 cuscinetti

Codice	Prodotto	U.m.	Conf.	D	L	M
25021500NY	∅ 15 nylon	nr	100	15	54,5	30

Piastra compatibile 070599RI/RIL



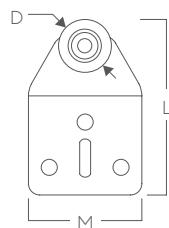

25.02 Carrucole 2 cuscinetti
15 kg portata max

Codice	Prodotto	U.m.	Conf.	D	L	M
25021502	∅ 15 f.z. piastra piegata	nr	50	15	49	30

Piastra compatibile 070599RI/RIL

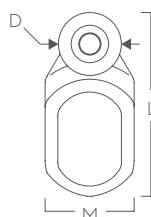

25.02 Carrucole 2 cuscinetti
10 kg portata max

Codice	Prodotto	U.m.	Conf.	D	L	M
25021505	∅ 15 asola nylon	nr	50	15	43	21

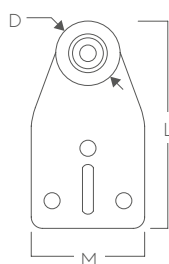

25.03 Carrucole 2 cuscinetti
10 kg portata max

Codice	Prodotto	U.m.	Conf.	D	L	M
25031500	∅ 15 f.z. - ruote nylon	nr	50	15	54,5	30

Piasa tra compatibile 070599RI/RIL

Binari, carrelli, ruote ø 24

Il sistema

Questa linea comprende binari ed accessori pensati per realizzare sistemi di porte scorrevoli, laterali in PVC, per interni ma anche per esterni.

Tecnica

Sistema estremamente flessibile anche grazie alle speciali curve per binari in acciaio. Tanti gli accessori disponibili come le carrucole girevoli per chiusure speciali.

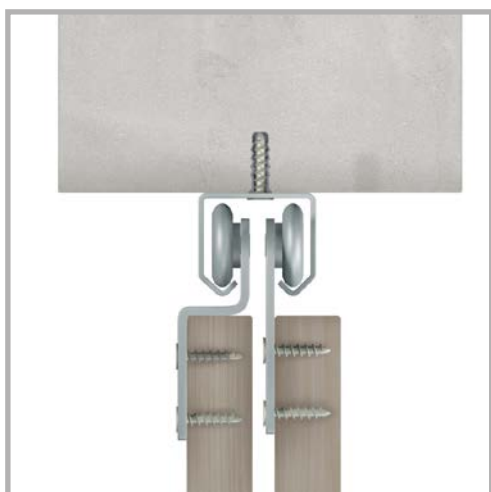

venticinque

→ carrucole, guide e accessori

∅ 24

25



25.19 Binari per carrucole 100 kg portata max

Codice	Prodotto	U.m.	Conf.	M	L	H
25192405	acciaio zincato per ruota ∅ 24	nr	5	33,5	5	30
disponibili anche da mt 4 - mt 6						
25192405AI	acciaio inox 304 per ruota ∅ 24	nr	5	33,5	5	30
disponibili anche da mt 6						
25192406AA	alluminio anodizzato per ruota ∅ 24	nr	5	33,5	6	30
25192406AB	alluminio bianco per ruota ∅ 24	nr	5	33,5	6	30

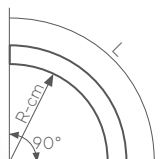

25.20 Curve per binari acciaio zincato 90 gradi

Codice	Prodotto	U.m.	Conf.	M	L
25200075	per ruota ∅ 24	nr	4	70 - 75	1220
25200100	per ruota ∅ 24	nr	4	100 - 105	1610
25200150	per ruota ∅ 24 solo su richiesta	nr	4	145 - 150	2325
25200200	per ruota ∅ 24 solo su richiesta	nr	4	200 - 205	3160

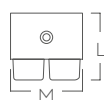

25.21 Paracolpi

Codice	Prodotto	U.m.	Conf.	L	M
25210024	∅ 24	nr	50	26	28

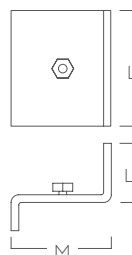

25.21 Staffe f.z. a parete per binari

Codice	Prodotto	U.m.	Conf.	L	L1	M
25210124	∅ 24	nr	30	45	23	36



venticinque

→ carrucole, guide e accessori

∅ 24

25

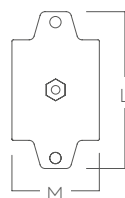

25.21 Staffe f.z. a soffitto per binari

Codice	Prodotto	U.m.	Conf.	L	M
25210224	∅ 24	nr	30	61	34

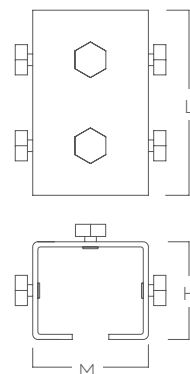

25.21 Giunzioni per binari

Codice	Prodotto	U.m.	Conf.	L	H	M
25211024	∅ 24	nr	4	72	38	45

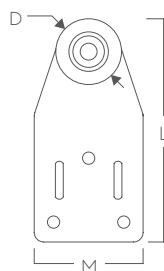

25.01 Carrucole 1 cuscinetto 25 kg portata max

Codice	Prodotto	U.m.	Conf.	D	L	M
25012400	∅ 24 f.z. piastra grande	nr	500	24	80	40

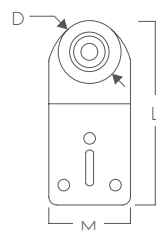

25.01 Carrucole 1 cuscinetto 25 kg portata max

Codice	Prodotto	U.m.	Conf.	D	L	M
25012403	∅ 24 f.z. piastra piegata	nr	50	24	80	40



venticinque

→ carrucole, guide e accessori

∅ 24

25

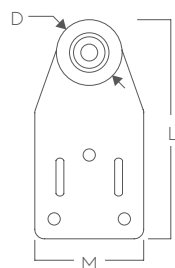

25.02 Carrucole 2 cuscinetti 35 kg portata max

Codice	Prodotto	U.m.	Conf.	D	L	M
25022400	∅ 24 f.z. piastra grande	nr	300	24	80,5	40
25022400AI304	∅ 24 acciaio inox 304 piastra grande	nr	100	24	80,5	40

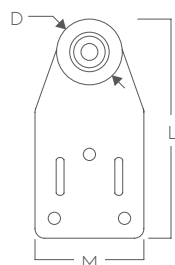

25.02 Carrucole 2 cuscinetti 35 kg portata max

Codice	Prodotto	U.m.	Conf.	D	L	M
25022401	∅ 24 f.z. piastra doppia	nr	300	24	80,5	40

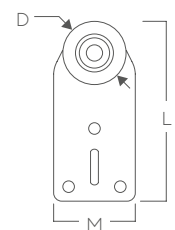

25.02 Carrucole 2 cuscinetti 35 kg portata max

Codice	Prodotto	U.m.	Conf.	D	L	M
25022402	∅ 24 f.z. piastra piccola	nr	400	24	66	30

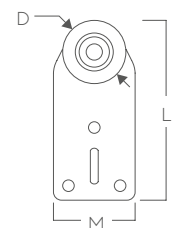

25.02 Carrucole 2 cuscinetti

Codice	Prodotto	U.m.	Conf.	D	L	M
25022402NY	∅ 24 nylon	nr	400	24	66	30

Piastra compatibile 070600RIC-RIL



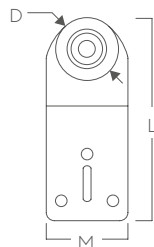

25.02 Carrucole 2 cuscinetti
35 kg portata max

Codice	Prodotto	U.m.	Conf.	D	L	M
25022403	∅ 24 f.z. piastra piegata	nr	30	24	74	30

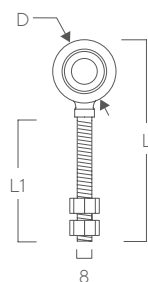

25.02 Carrucole 2 cuscinetti
35 kg portata max

Codice	Prodotto	U.m.	Conf.	D	L	L1
25022404F	∅ 24 f.z. perno fisso M8	nr	30	24	76	46

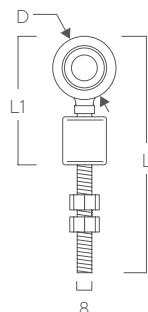

25.02 Carrucole 2 cuscinetti
35 kg portata max

Codice	Prodotto	U.m.	Conf.	D	L	L1
25022404	∅ 24 f.z. perno girevole M8	nr	20	24	92	50

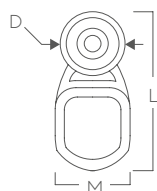

25.02 Carrucole 2 cuscinetti
25 kg portata max

Codice	Prodotto	U.m.	Conf.	D	L	M
25022405	∅ 24 asola nylon	nr	50	24	56	20



venticinque

→ carrucole, guide e accessori

∅ 24

25

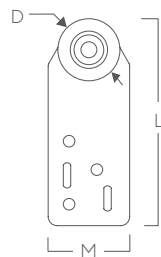

25.02 Carrucole 2 cuscinetti 35 kg portata max

Codice	Prodotto	U.m.	Conf.	D	L	M
25022406	∅ 24 f.z. - piastra lunga	nr	300	24	103	30

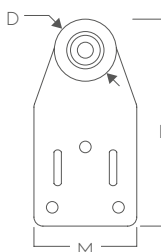

25.03 Carrucole 2 cuscinetti 35 kg portata max

Codice	Prodotto	U.m.	Conf.	D	L	M
25032400	∅ 24 f.z. - ruote nylon	nr	300	24	80,5	40

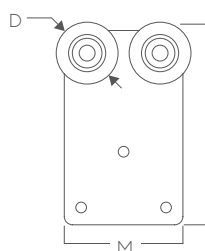

25.04 Carrucole 4 cuscinetti 45 kg portata max

Codice	Prodotto	U.m.	Conf.	D	L	M
25042400	∅ 24 f.z. piastra dritta	nr	150	24	86	46

Piastra compatibile 25100200/210/220/230/235

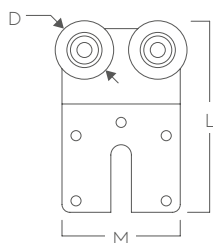

25.04 Carrucole 4 cuscinetti 45 kg portata max

Codice	Prodotto	U.m.	Conf.	D	L	M
25042402	∅ 24 f.z. piastra piegata	nr	150	24	76	46

Piastra compatibile 25100401



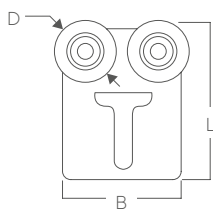

25.04 Carrucole 4 cuscinetti

Codice	Prodotto	U.m.	Conf.	D	L	B
25042403	∅ 24 f.z.	nr	15	24	52,5	50

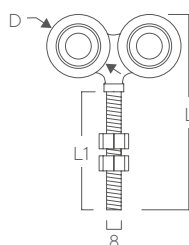

25.04 Carrucole 4 cuscinetti
30 kg portata max

Codice	Prodotto	U.m.	Conf.	D	L	L1
25042404F	∅ 24 f.z. perno fisso M8	nr	15	24	74	46

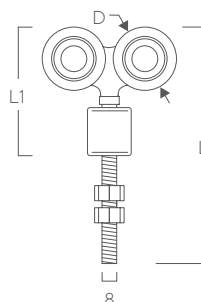

25.04 Carrucole 4 cuscinetti
30 kg portata max

Codice	Prodotto	U.m.	Conf.	D	L	L1
25042404FD	∅ 24 f.z. perno fisso ruota delrin M8	nr	20	24	76	46

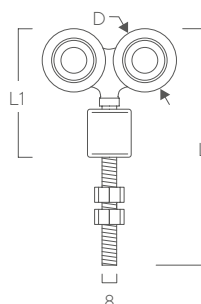

25.04 Carrucole 4 cuscinetti
40 kg portata max

Codice	Prodotto	U.m.	Conf.	D	L	L1
25042404	∅ 24 f.z. perno girevole M8	nr	15	24	92	50

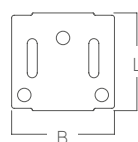

25.10 Contropiastre f.z. per carrucole

Codice	Prodotto	U.m.	Conf.	D	L	B
25100200	per 25022400	nr	300		35	40



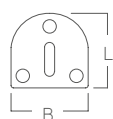

25.10 Contropiastre f.z. per carrucole

Codice	Prodotto	U.m.	Conf.	D	L	B
25100202	per 25022402	nr	400		30	30

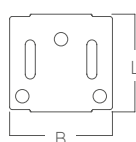

25.10 Contropiastre nylon per carrucole

Codice	Prodotto	U.m.	Conf.	D	L	B
25100210	per 25022400 senza rivetto	nr	300		35	40
25100210N	per 25022400 nero senza rivetto	nr	300		35	40
25100220	per 25022400 rivetto 5x8 f.z. (09050508)	nr	300		35	40
25100230	per 25022400 rivetto 5x10 all. (09051510)	nr	300		35	40
25100235	per 25022400 rivetto 5x10 f.z. (09050510)	nr	300		35	40

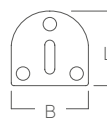

25.10 Contropiastre nylon per carrucole

Codice	Prodotto	U.m.	Conf.	L	B
25100212	per 25022402 senza rivetto	nr	400	30	30
25100240	per 25022402 rivetto 5x10 all. (09051510)	nr	400	30	30

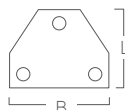

25.04 Contropiastre esagonali nylon per carrucole

Codice	Prodotto	U.m.	Conf.	L	B
25100211	per 25022400 senza rivetto	nr	300	33	39
25100250	per 25022400 rivetto 5x10 all. (09051510)	nr	300	33	39
25100250C	per 25022400 rivetto 5x8 f.z. (09050508)	nr	300	33	39
25100250L	per 25022400 rivetto 5x10 f.z. (09050510)	nr	300	33	39

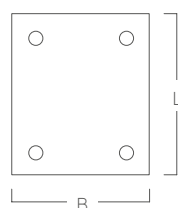

25.10 Contropiastre f.z. per carrucole

Codice	Prodotto	U.m.	Conf.	L	B
25100401	per 25042402	nr	200	38	43



Binari, carrelli, ruote ø 38

Il sistema

Sistema pensato per l'industria, ideale per la realizzazione di serre, stalle, fienili e per la realizzazione di gazebo, coperture e tensostrutture scorrevoli.

Tecnica

Binari in acciaio pensati per ante di qualsiasi materiale. Numerosi gli accessori dedicati al mondo dell'industria.

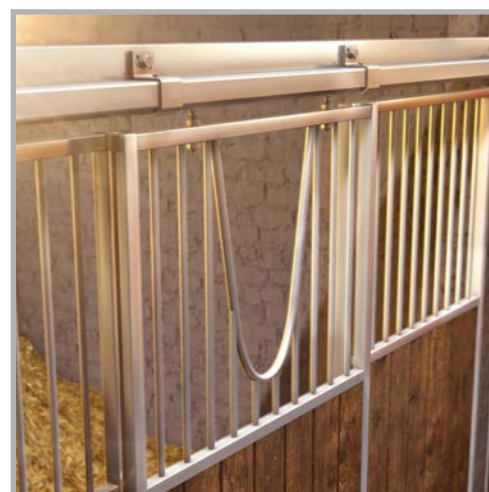
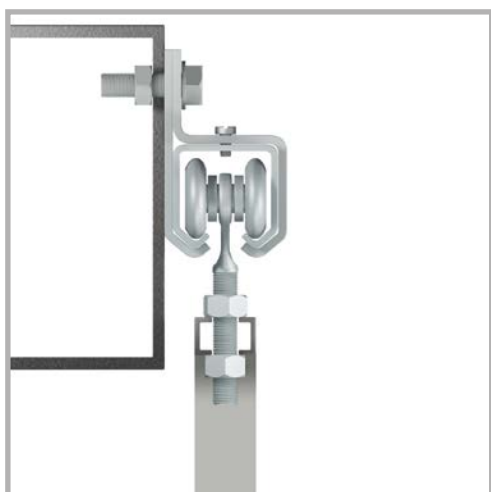

venticinque

→ carrucole, guide e accessori

∅ 38

25

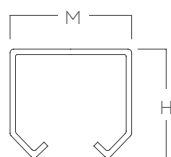

25.19 Binari per carrucole 350 kg portata max

Codice	Prodotto	U.m.	Conf.	M	L	H
25193805	acciaio zincato per ruota d.38	nr	3	48	6	48

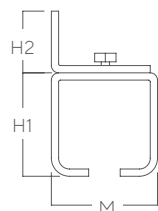

25.21 Staffe f.z. a parete per binari

Codice	Prodotto	U.m.	Conf.	M	H	H1
25210138	∅ 38	nr	4	58,5	57	34

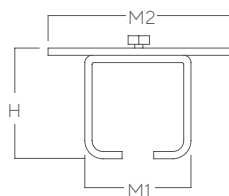

25.21 Staffe f.z. a soffitto per binari

Codice	Prodotto	U.m.	Conf.	M1	M2	H
25210238	∅ 38	nr	4	58,5	100	61



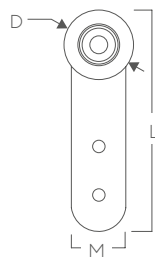

25.02 Carrucole 2 cuscinetti
160 kg portata max

Codice	Prodotto	U.m.	Conf.	D	L	M
25023802	∅ 38 f.z. con fori	nr	25	38	122	30

Contropiastra compatibile 50121760

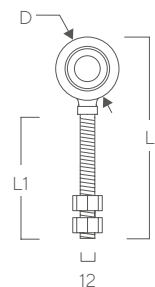

25.02 Carrucole 2 cuscinetti
160 kg portata max

Codice	Prodotto	U.m.	Conf.	D	L	L1
25023804F	∅ 38 f.z. perno fisso M12	nr	25	38	115	60

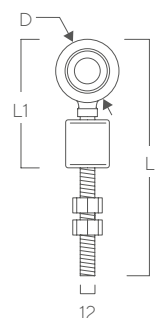

25.02 Carrucole 2 cuscinetti
160 kg portata max

Codice	Prodotto	U.m.	Conf.	D	L	L1
25023804	∅ 38 f.z. perno girevole M12	nr	12	38	147	69



venticinque

→ carrucole, guide e accessori

∅ 38

25

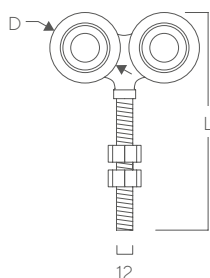

25.04 Carrucole 4 cuscinetti
200 kg portata max

Codice	Prodotto	U.m.	Conf.	D	L
25043804F	∅ 38 f.z. perno fisso M12	nr	12	38	115

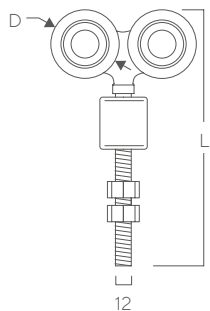

25.04 Carrucole 4 cuscinetti
200 kg portata max

Codice	Prodotto	U.m.	Conf.	D	L
25043804	∅ 38 f.z. perno girevole M12	nr	12	38	127

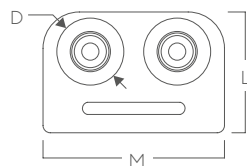

25.04 Carrucole 4 cuscinetti
210 kg portata max

Codice	Prodotto	U.m.	Conf.	D	L	M
25043800	∅ 38 f.z. con asola	nr	30	38	63	100



Binari, carrelli, ruote ø 44

Il sistema

Questo sistema è pensato per l'industria ed è ideale per la realizzazione di grandi coperture.

Tecnica

Binario dalla grande resistenza con carrelli rinforzati in acciaio ad alta tenuta e tipologie di utilizzo simili alle versioni precedenti.

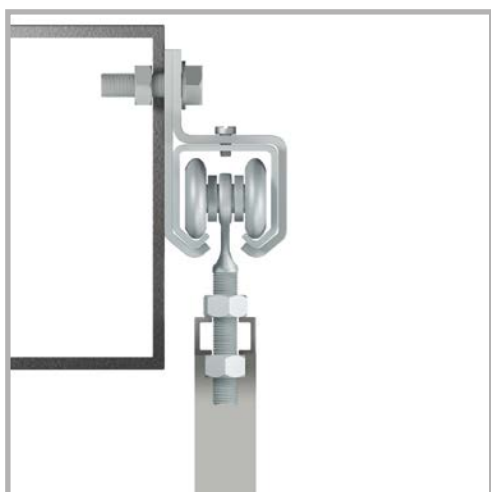

venticinque

→ carrucole, guide e accessori

∅ 44

25

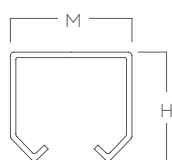

25.19 Binari per carrucole
450 kg portata max

Codice	Prodotto	U.m.	Conf.	M	L	H
25194405	acciaio zincato per ruota ∅44	nr	2	42	6	54

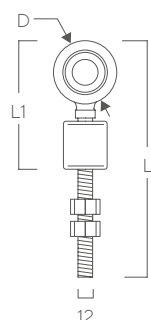

25.02 Carrucole 2 cuscinetti
160 kg portata max

Codice	Prodotto	U.m.	Conf.	D	L	L1
25024404	∅44 f.z. perno girevole M12	nr	12	44	155	72

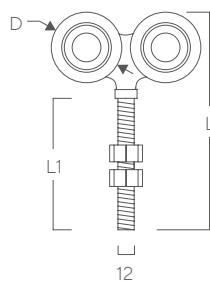

25.04 Carrucole 4 cuscinetti
220 kg portata max

Codice	Prodotto	U.m.	Conf.	D	L	L1
25044404F	∅44 f.z. perno fisso M12	nr	12	44	115	60

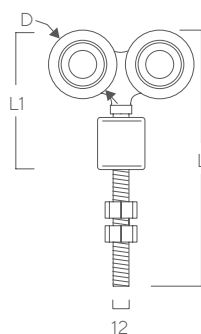

25.04 Carrucole 4 cuscinetti
220 kg portata max

Codice	Prodotto	U.m.	Conf.	D	L	L1
25044404	∅44 f.z. perno girevole M12	nr	12	44	155	72



venticinque

→ carrucole, guide e accessori

∅ 44

25

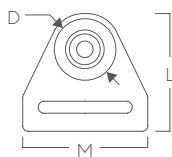

25.02 Carrucole 2 cuscinetti 160 kg portata max

Codice	Prodotto	U.m.	Conf.	D	L	M
25024401	∅ 44 f.z. con asola	nr	20	44	65	70

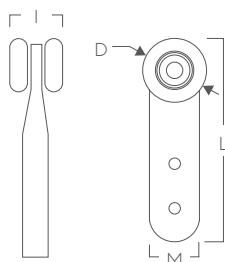

25.02 Carrucole 2 cuscinetti 160 kg portata max

Codice	Prodotto	U.m.	Conf.	D	L	M	I
25024402	∅ 44 f.z. con fori	nr	50	44	125	30	31,5

Contropiastra compatibile 50121760

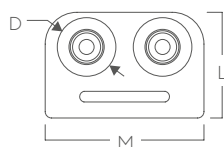

25.04 Carrucole 4 cuscinetti 210 kg portata max

Codice	Prodotto	U.m.	Conf.	D	L	M
25044400	∅ 44 f.z. con asola	nr	30	44	65	100



venticinque

→ carrucole, guide e accessori

25



25.50 Carrelli per tende da sole

Codice	Prodotto	U.m.	Conf.
25500010	1 ruota acciaio zincato	A	nr 100
25500011	1 ruota acciaio inox	B	nr 100
25500090	Supporto per art.25500010 acciaio zincato	C	nr 100
25500091	Supporto per art.25500011 acciaio inox	D	nr 100

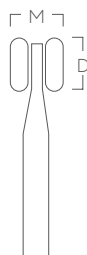
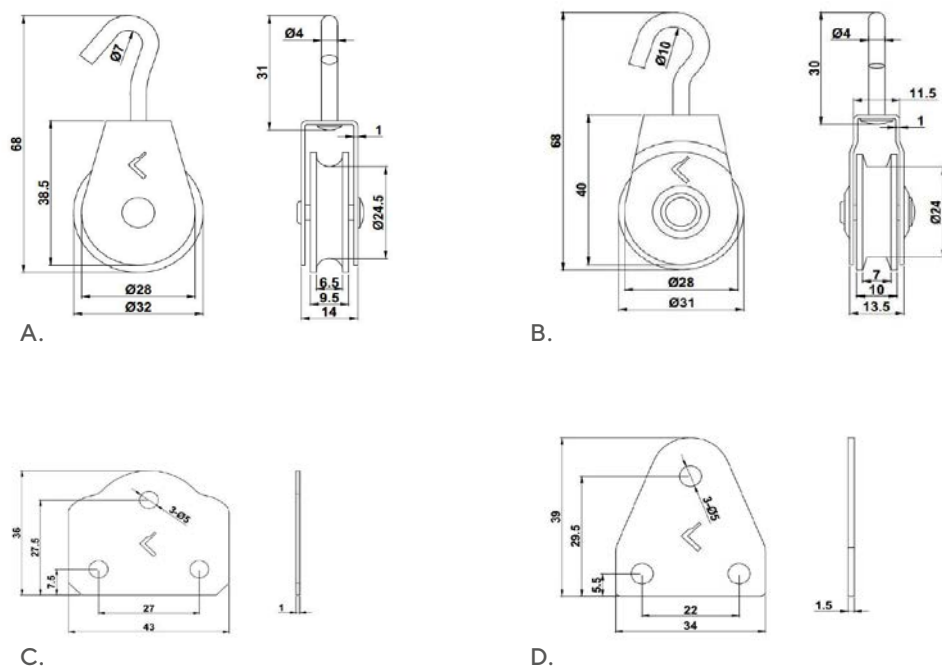

25.50 Carrelli nylon

Codice	Prodotto	U.m.	Conf.	D	M
25500100	2 ruote nylon	nr	100	16	13
25500200	2 ruote nylon con rivetto incorporato	nr	100	16	13



/
TRENTA

Nastrini, tubetti
e profili in pvc

300

trenta

→ nastri, tubetti e profili in pvc

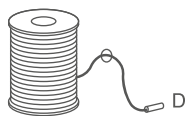

30

Tabella colori nastri

Prodotto	U.m.	Rot.
Nastro apprettato 20 mm	ml	150

	101/G604		409		606
	102/G687		502		702/G070
	201/Z661		506		703/G316
	301/G050		509/G252		704/Z645
	302/G180		510/Z650		708/G822
	355/G142		575		707/G038
	401/G211		601/G599		706/G596
	402/G209		603		801/Z647
	404/G101		605/G245		802/G102
	407/G221				901/G170
	408/R035				



trenta

→ nastri, tubetti e profili in pvc

30



30.01 Nastrino dralon 100%

Codice	Prodotto	U.m.	Rot.	L	H
3001000N	nastrino dralon 100%	ml	150	150	20

Riferimento colori come da cartella colori nastrino

A richiesta **Nastrino filato RAYTENT®**

Raytent è il primo filato acrilico tinto in massa di riciclo pre-consumo, ovvero recuperato da materiale nuovo scartato durante la lavorazione industriale.



30.08 Tubetto pvc esterni

Codice	Prodotto	U.m.	Rot.	D	gr/ml
3008000E	Ø 08	kg	15	8	55
3009000E	Ø 09	kg	15	9	75
3010000E	Ø 10	kg	15	10	95

Riferimento colori come da cartella colori nastrino

Ordine minimo 50kg



32.01 Profilo pvc 656

Codice	Prodotto	U.m.	Rot.	gr/ml
32018656	bianco mm 18	ml	200	50

Riferimento colori come da cartella colori nastrino

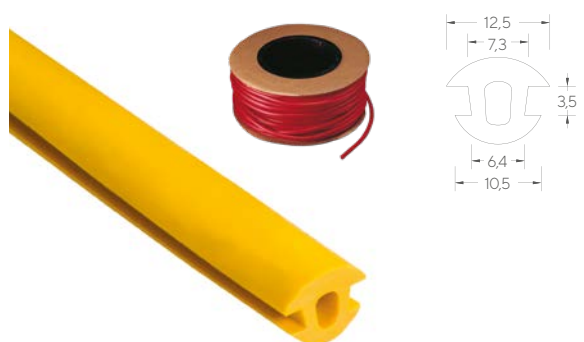

30.12 Profilo a spina per capottine

Codice	Prodotto	U.m.	Rot.	D	gr/ml
3012000F	Ø 12,5	kg	15	12,5	120

Riferimento colori come da cartella colori nastrino



trenta

→ nastri, tubetti e profili in pvc

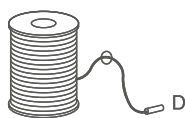

30

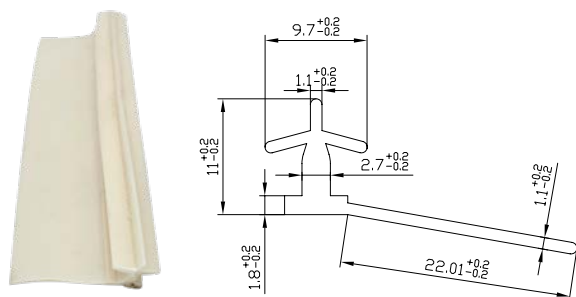

30.13 Strappo rapido per tende da sole

Codice	Prodotto	U.m.	Rot.
30131022	PVC 75 Shore	mt	70

colore a seconda della disponibilità oppure a richiesta con un minimo d'ordine



30.20 Tubetto pvc per interni

Codice	Prodotto	U.m.	Rot.	D	gr/ml
302003IM	Ø 03	kg	10	3	10
302004IM	Ø 04	kg	15	4	15
302005IM	Ø 05	kg	15	5	25
302006IM	Ø 06	kg	15	6	35
302007IM	Ø 07	kg	15	7	42
302008IM	Ø 08	kg	15	8	55



30.25 Tubetto rigido pvc per interni

Codice	Prodotto	U.m.	Rot.	D	gr/ml
302504IRML	Ø 04 nero	ml	500	4	15
302505IRML	Ø 05 nero	ml	300	5	23
302506IRML	Ø 06 nero	ml	300	6	32
302507IRML	Ø 07 nero	ml	300	7	43
302508IRML	Ø 08 nero	ml	300	8	56



trenta

→ nastri, tubetti e profili in pvc

30



30.30 Tondino pvc pieno

Codice	Prodotto	U.m.	Rot.	D	gr/ml
303003TP	Ø 03	kg	15	3	12
303004TP	Ø 04	kg	15	4	20
303005TP	Ø 05	kg	15	5	29
303006TP	Ø 06	kg	15	6	42
303007TP	Ø 07	kg	15	7	57
303008TP	Ø 08	kg	15	8	75
303009TP	Ø 09	kg	15	9	97
303010TP	Ø 10	kg	15	10	118
303011TP	Ø 11	kg	15	11	142
303012TP	Ø 12	kg	15	12	170

A richiesta trasparente



/
TRENTADUE

Profili pvc, profili alluminio
& Guaine





32.01 Profili pvc

Codice	Prodotto	U.m.	Conf.	gr/mt	d	L
32010346	346 con aletta bianco	kg	13	86	7	19
32010346G	346 con aletta grigio	kg	13	86	7	22



32.01 Profili pvc

Codice	Prodotto	U.m.	Conf.	gr/mt	d	L
32010351	351 con aletta nero	kg	10	67	5,4	14,7



32.01 Profili pvc

Codice	Prodotto	U.m.	Conf.	gr/mt	d	L
32010434	434 con aletta bianco	kg	15	34	4,5	14

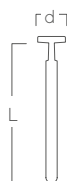

32.01 Profili pvc

Codice	Prodotto	U.m.	Conf.	gr/mt	d	L
32010463	463 con aletta bianco	kg	15	75	6	24



32.01 Profili pvc

Codice	Prodotto	U.m.	Conf.	gr/mt	d
32010784	723 con aletta bianco	ml	100	140	9

A richiesta altri colori



trentadue

→ profili pvc

32

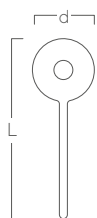

32.01 Profili pvc

Codice	Prodotto	U.m.	Conf.	d
32010854	854 con aletta 14 mm trasparente	ml	150	7

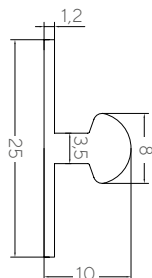

32.01 Profili pvc

Codice	Prodotto	U.m.	Conf.	gr/mt	d
32010838	838 per pergola bianco	ml	100	95	8

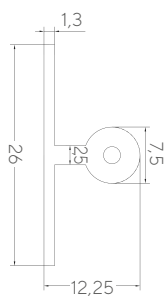

Codice	Prodotto	U.m.	Conf.	gr/mt	d
32010979	979 bianco	ml	100	150	7,5



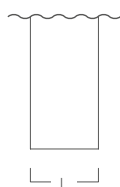

32.01 Profili pvc

Codice	Prodotto	U.m.	Conf.	gr/mt	S	L
32010751	751 mm 14,7 x 3,2 · 65 Shore Per tensionamento banner pubblicitari	ml	250	56	3,2	14,7

78.48 Zip speciali per chiusure trasparenti schermanti e oscuranti

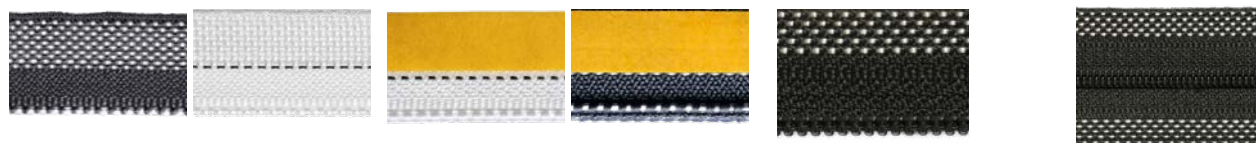

	INGOMBRO ZERO		INGOMBRO ZERO colla spalmata PU		NYGUARD CT4	CT4 SALDABILE a richiesta oscurante	
Codice	78480054	78480055	78480057	78480058	78480015	78480025	78480030
Prodotto	semicatena saldabile grigia ad alta frequenza	semicatena saldabile bianca ad alta frequenza	semicatena saldabile bianca ad alta frequenza	semicatena saldabile grigia ad alta frequenza	nastro thermo-pvc saldabile ad alta frequenza	saldabile bianca ad alta frequenza	saldabile nera ad alta frequenza
Nastro	100% poliestere ordito PVC		100% poliestere + colla PU		poliestere testurizzato	100% poliestere	
Catena	100% poliestere		100% poliestere		poliammide 6	monofilo 100% poliestere	
Cucirino	100% poliestere		100% poliestere		poliestere Tit.80/3Nm	100% poliestere alta tenacità	
	Prova di tenuta trazione laterale				Prova di tenuta trazione laterale (no semicatena)		
Forza	130 kg	130 kg		75 kg		60 kg	
Lunghezza rotoli - mt	300	300	300	300	200	200	200

Tutti i dettagli nella sez. 78



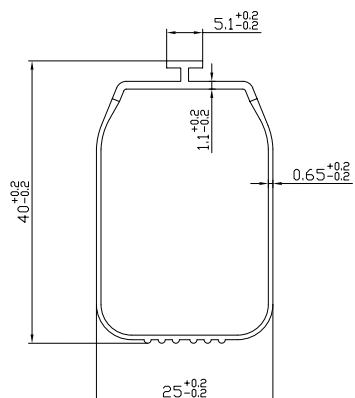
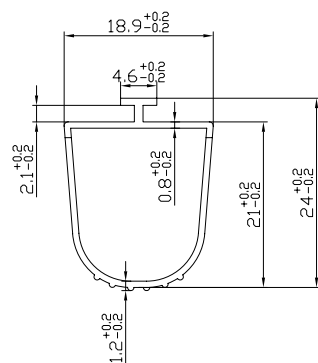
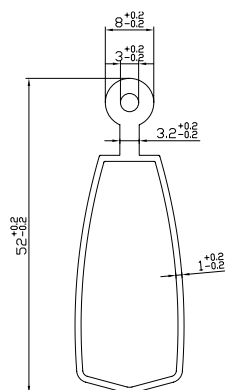

32.01 Profili per antivento solo su richiesta

Codice	Prodotto	U.m.	Conf.
32010917	terminale PVC morbido shore65 per antivento steccata	mt	30

Codice	Prodotto	U.m.	Conf.
320101070	terminale PVC rigido/morbido coestruso per antivento motorizzata	mt	max 4

Codice	Prodotto	U.m.	Conf.
320101076	terminale PVC rigido/morbido coestruso per antivento motorizzata	mt	max 4

Disponibili nei colori: bianco, avorio, marrone e nero





Monospalmato bianco

Usato per produzione standard di guaine da Ø 10 mm a Ø 13,5 mm



Monospalmato bianco

Usato per produzione standard di guaine da Ø 4 mm a Ø 8,5 mm



Monospalmato bianco 2200 Dtex

Usato per produzione di guaine da Ø 7,5 mm a Ø 13,5 mm

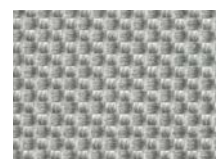

Monospalmato grigio

Usato per produzione standard di guaine da Ø 10 mm a Ø 13,5 mm



Monospalmato grigio

Usato per produzione standard di guaine da Ø 4 mm a Ø 8,5 mm



Monospalmato nero

Usato per produzione standard di guaine da Ø 4 mm a Ø 8,5 mm

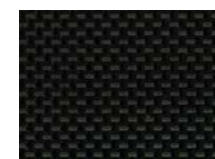

Monospalmato nero

Usato per produzione standard di guaine da Ø 10 mm a Ø 13,5 mm

A richiesta guaine con PVC bispalmato

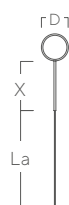
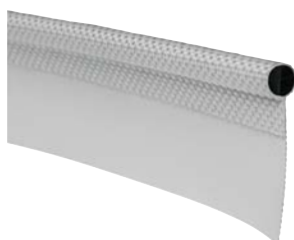

32.20 Guaina 1 aletta

Codice	Prodotto	U.m.	Conf.	D	L	La	X
32201055*	Ø 5,5 bianca	ml	100	5,5	100	20	10
32201065*	Ø 6,5 bianca	ml	100	6,5	100	20	10
32201075*	Ø 7,5 bianca	ml	100	7,5	100	20	10
32201085*	Ø 8,5 bianca	ml	100	8,5	100	25	10
32201100	Ø 10,0 bianca	ml	100	10,0	100	25	10
32201115	Ø 11,5 bianca	ml	100	11,5	100	38	10
32201135	Ø 13,5 bianca	ml	100	13,5	100	30	10
32201075G	Ø 7,5 grigia	ml	100	7,5	100	20	10
32201075N	Ø 7,5 nera	ml	100	7,5	100	20	10

* disponibili anche Ø 4/5/6/7/8

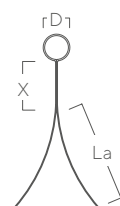
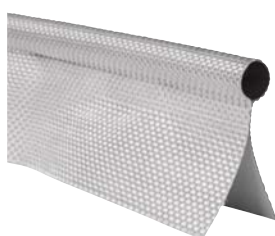

32.22 Guaina 2 alette aperte

Codice	Prodotto	U.m.	Conf.	D	L	La	X
32222055*	Ø 5,5 bianca	ml	100	5,5	100	20	10
32222065*	Ø 6,5 bianca	ml	100	6,5	100	20	10
32222075*	Ø 7,5 bianca	ml	100	7,5	100	20	10
32222085*	Ø 8,5 bianca	ml	100	8,5	100	25	10
32222075G	Ø 7,5 grigia	ml	100	7,5	100	20	10
32222075N	Ø 7,5 nera	ml	100	7,5	100	20	10

* disponibili anche Ø 4/5/6/7/8

A richiesta altre misure



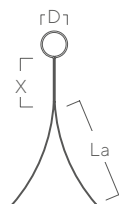
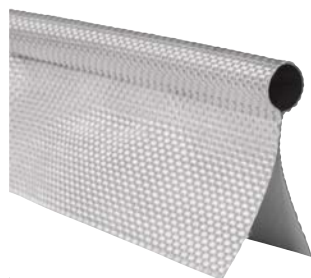

32.22 Guaina 2 alette aperte

Codice	Prodotto	U.m.	Conf.	D	L	La	X
32222100	Ø10,0 bianca	ml	100	10,0	100	25	10
32222115	Ø11,5 bianca	ml	100	11,5	100	38	10
32222115N	Ø11,5 nera	ml	100	11,5	100	38	10
32222135	Ø13,5 bianca	ml	100	13,5	100	35	10
32222135N	Ø13,5 nera	ml	100	13,5	100	35	10

A richiesta altre misure

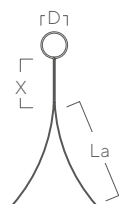

32.22 Guaina 2 alette aperte 2200 DTEX

Codice	Prodotto	U.m.	Conf.	D	L	La	X
322220752	Ø7,5 bianca	ml	100	7,5	100	40	5
322220852	Ø8,5 bianca	ml	100	8,5	100	25	10
322221152	Ø11,5 bianca	ml	100	11,5	100	35	10
322221352	Ø13,5 bianca	ml	100	13,5	100	35	10

A richiesta altre misure

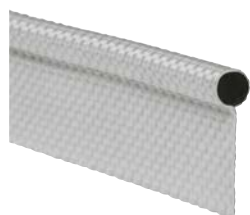

32.23 Guaina 2 alette saldate

Codice	Prodotto	U.m.	Conf.	D	L	X
32232070	Ø7,0 bianca	ml	100	7,0	100	20
32232075	Ø7,5 bianca	ml	100	7,5	100	20
32232085	Ø8,5 bianca	ml	100	8,5	100	20

A richiesta altre misure

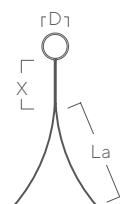

32.25 Guaina oscurante

Codice	Prodotto	U.m.	Conf.	D	L	La	X
32254115	Ø 11,5 2 alette aperte	ml	100	11,5	100	38	10
32254116	Ø 11,5 1 aletta	ml	100	11,5	100	38	10
32254135	Ø 13,5 2 alette aperte	ml	100	13,5	100	35	10
32254136	Ø 13,5 1 aletta	ml	100	13,5	100	35	10

A richiesta altre misure

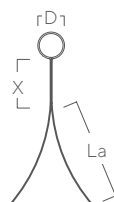

32.26 Guaina 2 alette aperte 2200 DTEX oscurante

Codice	Prodotto	U.m.	Conf.	D	L	La	X
32264075	Ø 7,5	ml	100	7,5	100	20	10
32264115	Ø 11,5	ml	100	11,5	100	38	10
32264135	Ø 13,5	ml	100	13,5	100	35	10

A richiesta altre misure



32.28 Guaina PVC 302 tensionabile con fisher D8 2 alette saldate

Codice	Prodotto	U.m.	Conf.	D	L	La	X
32282075	Ø 7,5 bianca	nr	100	7,5	100	-	20
32282075A	Ø 7,5 avorio	nr	100	7,5	100	-	20





A



B



07.32 Ganci per guaina

Codice	Prodotto	U.m.	Conf.	A	D	M
073222FZ	piegato f.z.	A	nr	100	20	15 8.80
073231FZ	diritto f.z.	B	nr	100	20	11 10

Piastra compatibile 070599RI-RIL

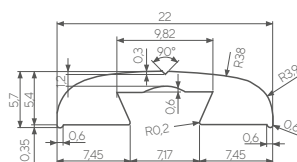

32.30 Profili alluminio piattina da rivettare

Codice	Prodotto	U.m.	Conf.
32302473	grezzo fermatelo mt. 3,00	ml	30
32302476	grezzo fermatelo mt. 6,00	ml	60

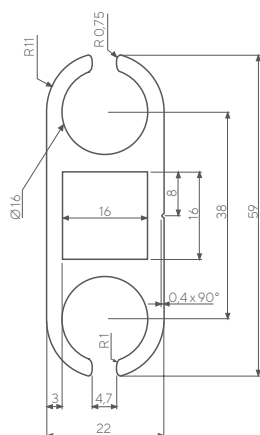
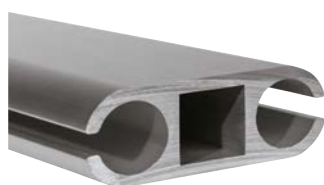

32.30 Profili alluminio per capannoni

Codice	Prodotto	U.m.	Conf.
32300060	anodizzato doppia ogiva - mt. 6,00	ml	12

Guaina compatibile Ø 11,5 mm - Ø 13,5 mm

A richiesta: grezzo

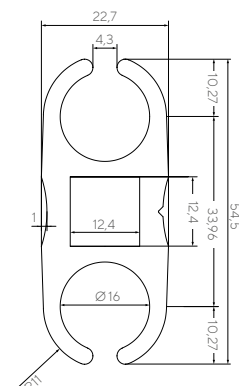

Codice	Prodotto	U.m.	Conf.
32300066	grezzo SMALL doppia ogiva - mt. 6,00	ml	60

Guaina compatibile Ø 11,5 mm - Ø 13,5 mm

Solo su richiesta

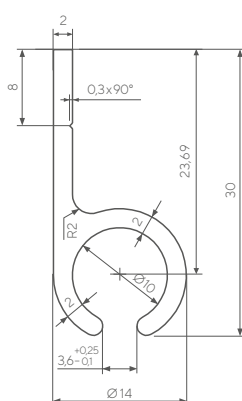

32.30 Profili alluminio con aletta

Codice	Prodotto	U.m.	Conf.
32300660	anodizzato mm 10 - uscita 180 gradi - mt 6,00	ml	60
32300660B	bianco mm 10 - uscita 180 gradi - mt 6,00	ml	60
32300660G	grezzo mm 10 - uscita 180 gradi - mt 6,00	ml	60



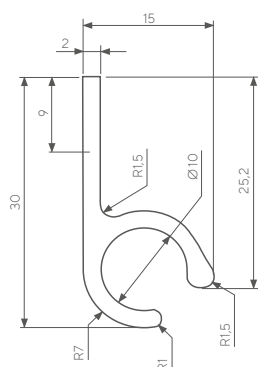

32.30 Profili alluminio con aletta

Codice	Prodotto	U.m.	Conf.
32300960	anodizzato mm 10 - mt. 6,00	ml	60
32300963	anodizzato mm 10 - mt. 3,00	ml	30
32300964	anodizzato mm 10 - mt. 4,00	ml	40
32300965	anodizzato mm 10 - mt. 5,00	ml	50
32300960G	grezzo mm 10 - mt. 6,00	ml	60

Disponibili anche verniciati:
bianco ral 9010 / avorio ral 1013 / marrone ral 8017 / nero ral 9005

Guaina compatibile Ø 7 mm - Ø 7,5 mm - Ø 8 mm - Ø 8,5 mm

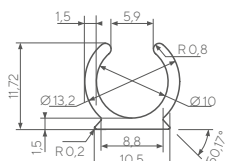

32.30 Profili alluminio per nautica

Codice	Prodotto	U.m.	Conf.
32300860	anodizzato mm 10 mt. 6,00	ml	120

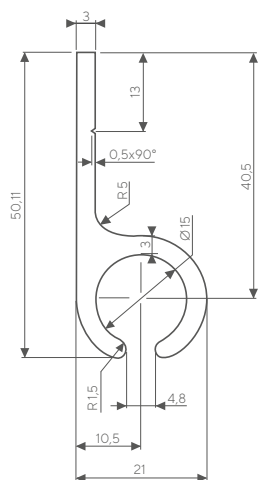

32.30 Profili alluminio con aletta

Codice	Prodotto	U.m.	Conf.
32301950	anodizzato mm 15 - mt. 5,00	ml	20
32301960	anodizzato mm 15 - mt. 6,00	ml	24

Guaina compatibile Ø 11,5 mm e Ø 13,5 mm



trentadue

→ profili alluminio e pvc

32

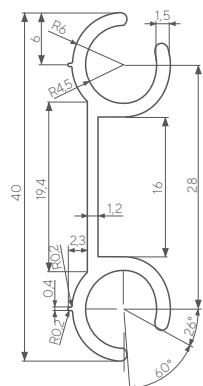
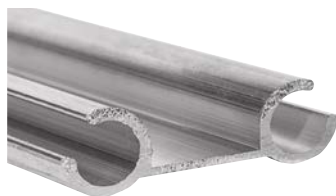

32.30 Profili alluminio doppio innesto

Codice	Prodotto	U.m.	Conf.
32302960	grezzo - mt. 6,00	ml	60

Guaina compatibile $\varnothing 7 \text{ mm} - \varnothing 7,5 \text{ mm}$

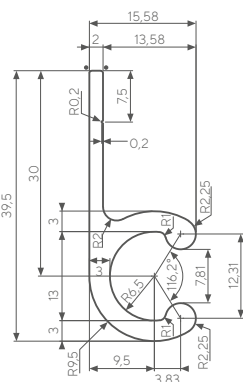

32.30 Profili alluminio ridotto con aletta

Codice	Prodotto	U.m.	Conf.
32300760	grezzo mt. 6,00	ml	60

Solo su richiesta - Ordine minimo 500kg

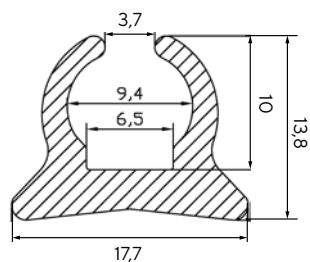

32.30 Profili PVC senza aletta

Codice	Prodotto	U.m.	Conf.
32304060	relinga bianco mt. 6,00	ml	60
32304064	relinga nero mt. 6,00	ml	60



trentadue

→ profili alluminio e pvc

32

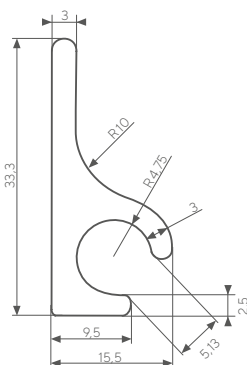

32.30 Profili PVC per nautica

Codice	Prodotto	U.m.	Conf.
32303960	mm 10 con aletta - mt. 6,00 bianco	ml	72
32303960N	mm 10 con aletta - mt. 6,00 nero	ml	72
32303963	mm 10 con aletta - mt. 3,00 bianco	ml	30

Guaina compatibile Ø 7,5 mm



32.01 Profili PVC per tende da campeggio

Codice	Prodotto	U.m.	Conf.	gr/mt	d
3201003CG	doppia 'C' - mt. 3,00 grigio	ml	30	230	8,5
3201003CB	doppia 'C' - mt. 3,00 bianco	ml	30	230	8,5
3201003CN	doppia 'C' - mt. 3,00 nero	ml	30	230	8,5

A richiesta altre lunghezze

Guaina compatibile Ø 7,5 mm

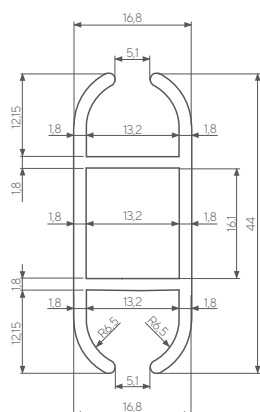
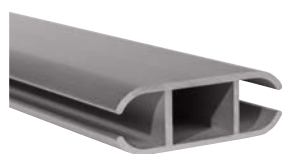

32.35 Profili alluminio 17x44mm

Codice	Prodotto	U.m.	Conf.
32353600	grezzo - mt. 6,00	ml	60
32353605	anodizzato - mt. 6,00	ml	60

Guaina compatibile Ø 11,5 mm · disponibile anche in barre mt 5,00

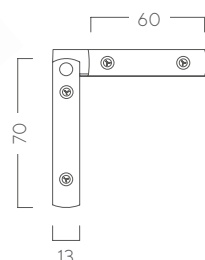

32.35 Raccordi f.z.

Codice	Prodotto	U.m.	Conf.
32353900	angolare per profilo mm 17x44	nr	10





32.35 Raccordi f.z.

Codice	Prodotto	U.m.	Conf.
32353910	per profilo mm 17x44	nr	10

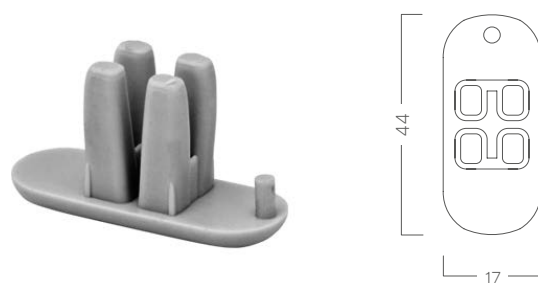

32.35 Tappi nylon

Codice	Prodotto	U.m.	Conf.
32353800	per profilo mm 17x44	nr	100



32.40 Manovelle piaghevoli

Codice	Prodotto	U.m.	Conf.
32404100	mt 1,3 trasmissione 7:1	nr	1
32404101	mt 2,4 trasmissione 7:1	nr	1
32404200	mt 2,7 trasmissione 7:1	nr	1
32404201	mt 3,1 trasmissione 7:1	nr	1



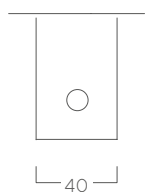
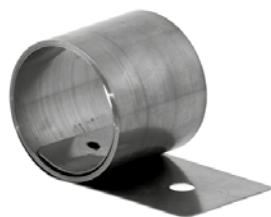

32.40 Molle a rilascio costante per arrotolamento EN 10088-2

Codice	Prodotto	U.m.	Conf.	A.	Spes.
32400500	mt. 0,50	nr	2	0,50	0,5 mm
32400600	mt. 0,60	nr	2	0,60	0,5 mm
32401100	mt. 1,10	nr	2	1,10	0,5 mm
32401500	mt. 1,50	nr	2	1,50	0,5 mm
32402000	mt. 2,00	nr	2	2,00	0,5 mm
32402300	mt. 2,30	nr	2	2,30	0,5 mm

A richiesta altre misure



Codice	Prodotto	U.m.	Conf.	A.
32402520	guida montaggio molle mt. 2,00	nr	1	2,00



Codice	Prodotto	U.m.	Conf.
32403000	pinza montaggio molle	nr	1

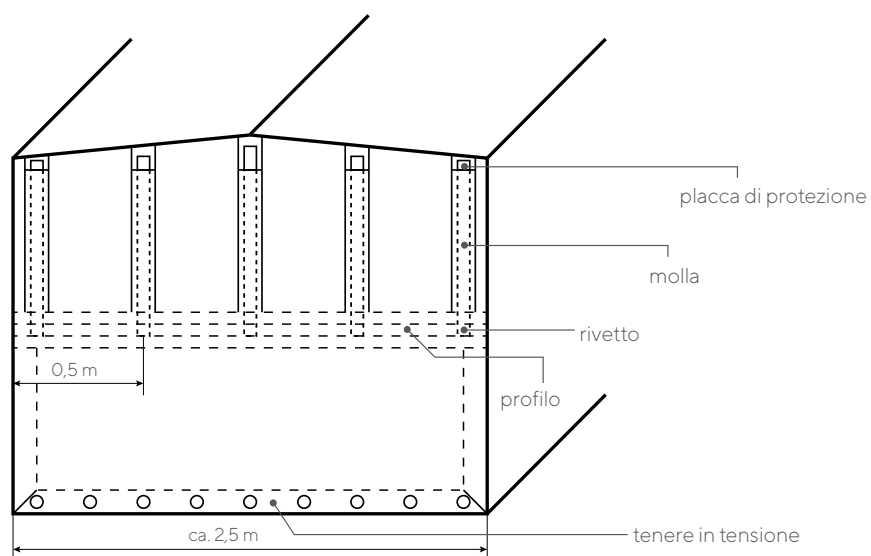



A



B



C

78.45 Zip per portoni industriali

Codice	Prodotto	U.m.	Conf.
78450040P	Cargoplus da saldare	mt	100
78450040RX	RH Zip dente rettangolare	mt	100
78450022NY	dentino nero ricambio con vite per CT20 e CARGOPLUS	A	nr 10
78450022NY1	dentino nero ricambio con vite per CT20 e CARGOPLUS	B	nr 10
78450023NY	dentino nero ricambio con vite per RH Zip	C	nr 10

CARGOPLUS

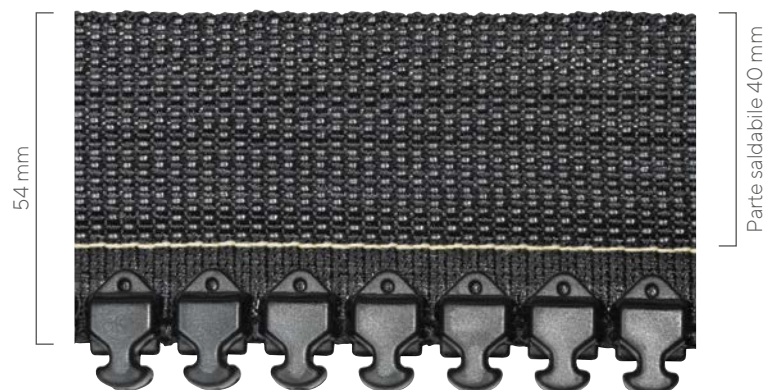

RH ZIP



78.45 Zip per portoni industriali

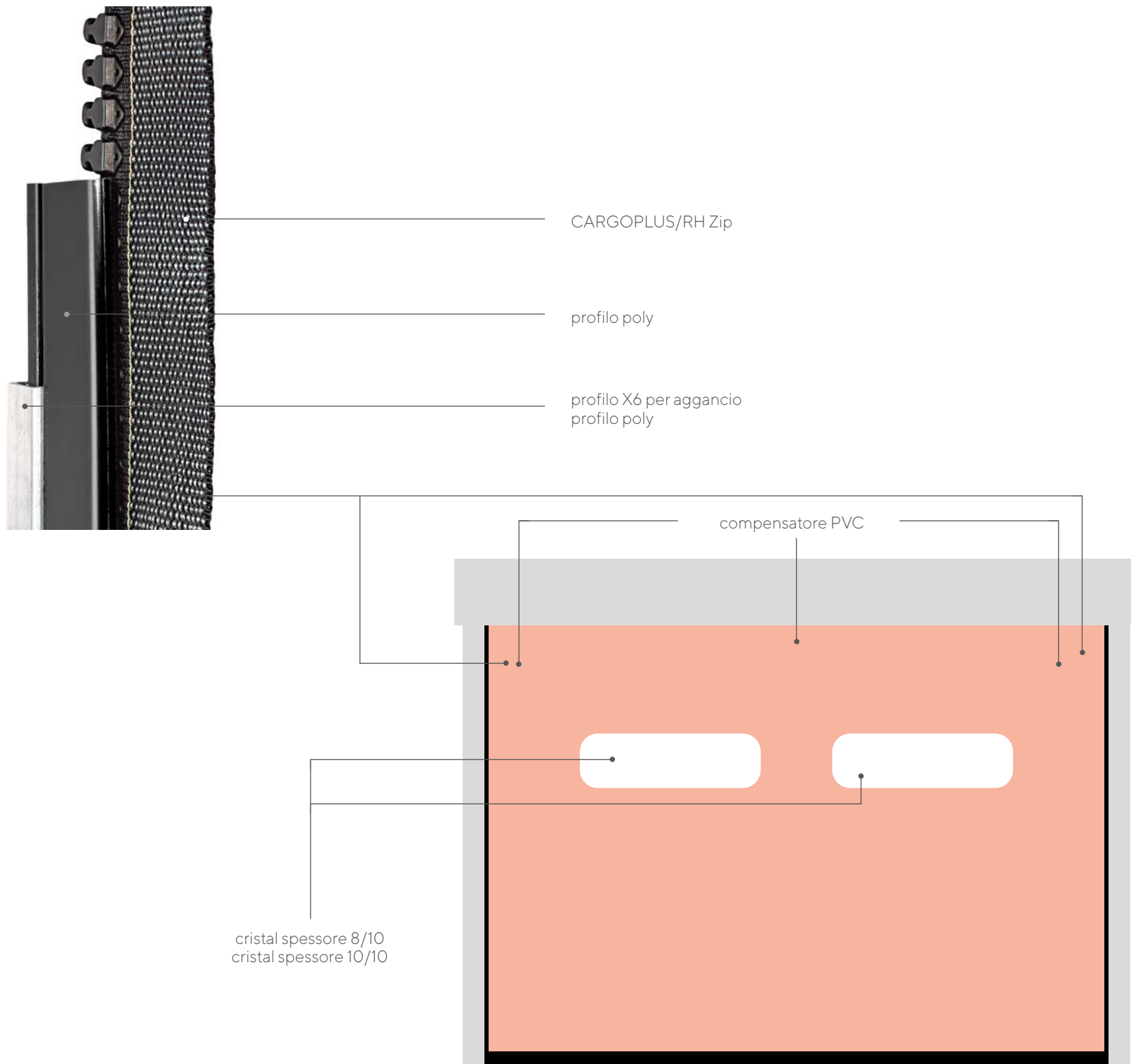

trentadue

→ accessori per porte ad arrotolamento rapido

32

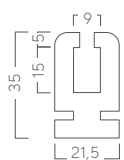
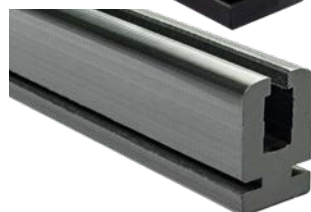
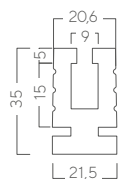
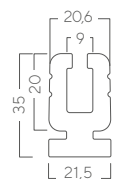

32.80 Profilo poly

Codice	Prodotto	U.m.	Conf.
Poly estruso *			
32800150N	NERO barre mt. 5,00	ml	50
32800160N	NERO barre mt. 6,00	ml	60
32800150V	NERO barre mt. 5,00 mod. V	ml	50
32800160V	NERO barre mt. 6,00 mod. V	ml	60

Poly fresato *

32800140FR	NERO barre mt. 4,00	ml	40
------------	---------------------	----	----

A richiesta altre lunghezze

*Polietilene nero - densità molecolare 1.000.000

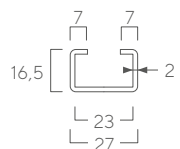

32.80 Profilo x6 f.z.

Codice	Prodotto	U.m.	Conf.
32800205	per Poly	mt	50
32800206	per Poly	mt	60

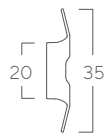

32.80 Compensatore

Codice	Prodotto	U.m.	Conf.
32800300	PVC trasparente 65 Shore	ml	50

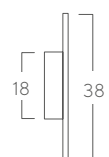

32.80 Compensatore

Codice	Prodotto	U.m.	L
32800310	PVC dentato	ml	25



32.80 Convogliatore

Codice	Prodotto	U.m.	Conf.
32800250	a "V" per zip	nr	1



trentadue

→ accessori per porte ad impacchettamento

32



32.80 Ovale f.z. con nastro nero cint. sicurezza

Codice	Prodotto	U.m.	Conf.	Anello	L
32800411	cm 11 *	pz	100	50x20x5	11
32800412	cm 12 *	pz	100	50x20x5	12
32800415	cm 15 *	pz	100	50x20x5	15
32800416	cm 16 *	pz	100	50x20x5	16
32800419	cm 19 *	pz	100	50x20x5	19
32800423	cm 23 *	pz	100	50x20x5	23

*per portoni ad impacchettamento

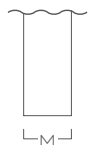

Codice	Prodotto	U.m.	Conf.	M
13655004	nastro cintura sicurezza mm 48 nero daN 2.650	ml	100	48

cinghiolo e nastro



cristal spessore 8/10
cristal spessore 10/10



/
QUARANTA

Sistemi di ancoraggio,
e sollevamento

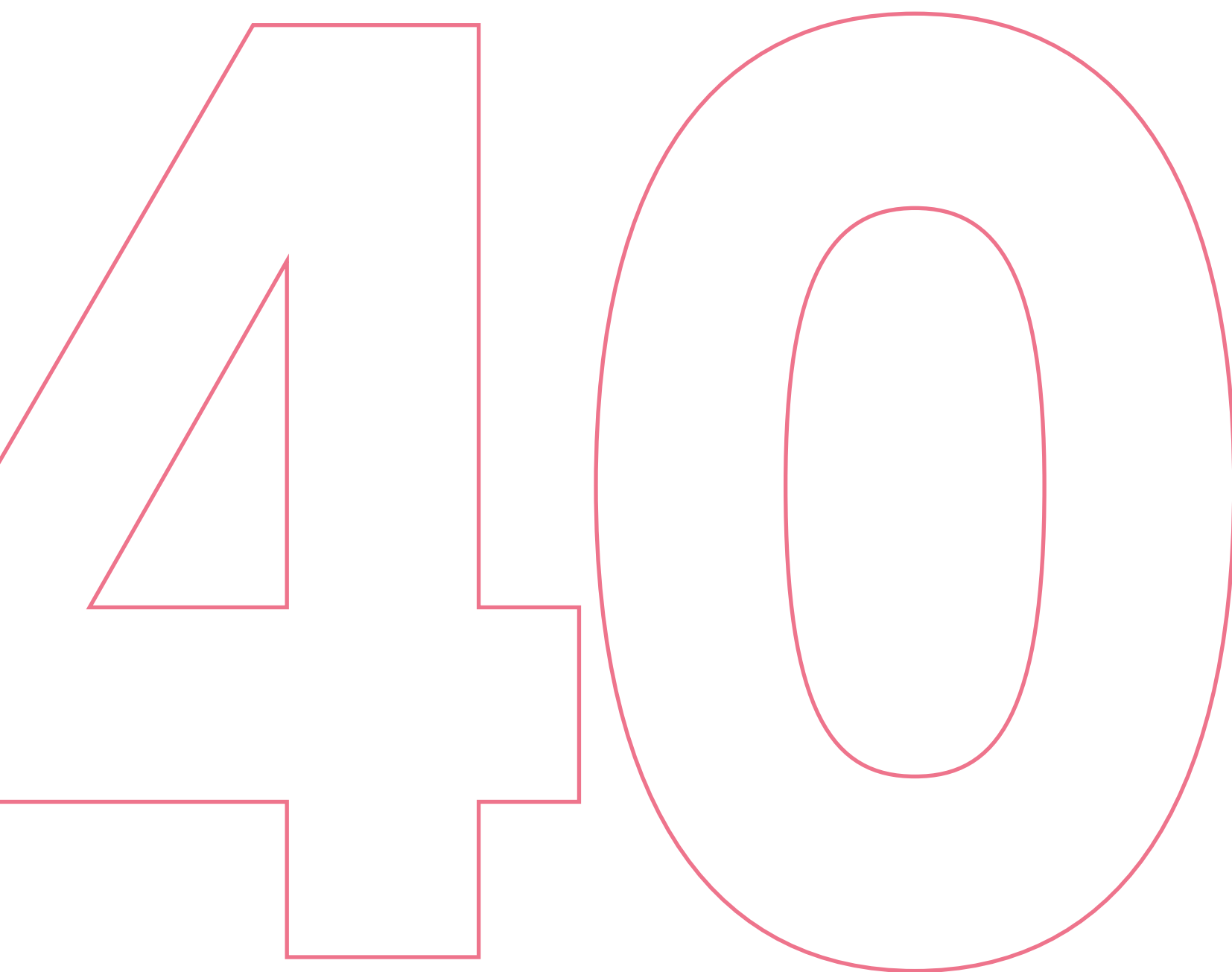

quaranta

→ sistemi di ancoraggio,
cricchetti e ganci

25 mm

40



40.01 Sistemi di ancoraggio

Codice	Prodotto	U.m.	Conf.	L	M	C/R nastro	kN
40010026	mm 25 kg 800 nastro bianco	nr	10	1,5	25	800	4
40010026N	mm 25 kg 800 nastro nero	nr	10	1,5	25	800	4
40010026AI	mm 25 kg 800 nastro bianco cricchetto acciaio inox 304	nr	10	1,5	25	800	4
40010027	mm 25 kg 800 nastro bianco	nr	10	2,5	25	800	4
40010029	mm 25 kg 800 nastro bianco	nr	10	6	25	800	4
40010029A	mm 25 kg 800 nastro arancio	nr	10	6	25	800	4
40010029B	mm 25 kg 800 nastro blu	nr	10	6	25	800	4
40010029R	mm 25 kg 800 nastro rosso	nr	10	6	25	800	4

A richiesta con nastro di altri colori e altre lunghezze

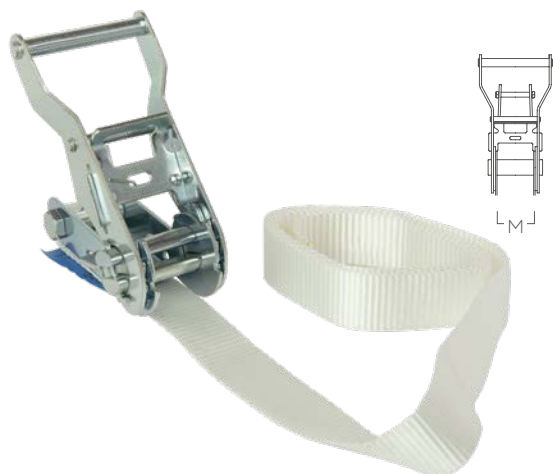

40.01 Sistemi di ancoraggio

Codice	Prodotto	U.m.	Conf.	L	M	C/R nastro	kN
40010028	mm 25 kg 1500 nastro bianco	nr	10	1,5	25	1.200	7,5
40010028AI	mm 25 kg 1500 acciaio inox 304	nr	10	1,5	25	1.200	7,5

A richiesta con nastro di altri colori e altre lunghezze

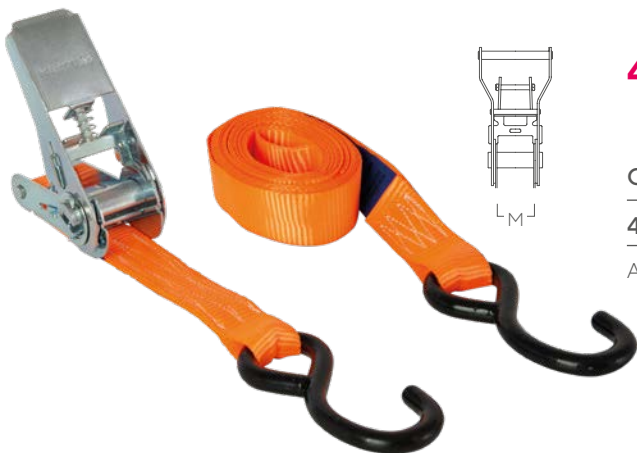

40.01 Sistemi di ancoraggio

Codice	Prodotto	U.m.	Conf.	L	M	C/R nastro	kN
40010025S	mm 25 kg 800 gancio a S	nr	25	0,5+4,00	25	800	4

A richiesta con nastro di altri colori e altre lunghezze



quaranta

→ sistemi di ancoraggio,
cricchetti e ganci

25 mm

40

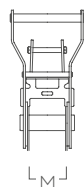

40.02 Cricchetti

Codice	Prodotto	U.M.	Conf.	M	Kg	kN
40032500	mm 25 kg 800 f.z.	nr	10	25	800	4
40032500AI	mm 25 kg 800 acciaio inox 304	nr	10	25	800	4



Codice	Prodotto	U.M.	Conf.	M	Kg	kN
40032501	mm 25 kg 1500 f.z.	nr	10	25	1.500	7,5



Codice	Prodotto	U.M.	Conf.	M	Kg	kN
40032501AI	mm 25 kg 1500 acciaio inox 304	nr	10	25	1.500	7,5



Codice	Prodotto	U.M.	Conf.	M	Kg	kN
40032504	mm 25 kg 1500 f.z. maniglia in gomma nera	nr	10	25	1.500	7,5



quaranta

→ sistemi di ancoraggio,
cricchetti e ganci

25 mm

40



40.05 Ganci uncino

Codice	Prodotto	U.m.	Conf.	M	Kg	filo
40050025I	mm 25 1 dito	nr	10	25	1.500	7
40050025	mm 25 2 dita	nr	10	25	1.500	7
40050026	mm 25 ricoperto PVC nero 2 dita	nr	10	25	1.500	8,8
40050025AI	mm 25 2 dita acciaio inox 304	nr	10	25	1.500	6,2



40.05 Ganci a "S"

Codice	Prodotto	U.m.	Conf.	M	Kg	L	filo
40050025S	mm 25 ricoperto in pvc	nr	10	25	500	105	8



quaranta

→ sistemi di ancoraggio, cricchetti e ganci

35 mm

40



40.01 Sistemi di ancoraggio

Codice	Prodotto	U.m.	Conf.	L	M	C/R nastro	kN
40010036	mm 35 kg 2000 nastro bianco	nr	10	1,5	35	3.000	10
40010036AI	mm 35 kg 2000 nastro bianco cricchetto acciaio inox	nr	10	1,5	35	3.000	10
40010037	mm 35 kg 2000 nastro bianco	nr	10	1,6	35	3.000	10

A richiesta con nastro di altri colori e altre lunghezze



40.01 Sistemi di ancoraggio

Codice	Prodotto	U.m.	Conf.	L	M	C/R nastro	kN
40010038	mm 35 kg 3000 nastro bianco	nr	10	1,5	35	3.000	15

A richiesta con nastro di altri colori e altre lunghezze



40.01 Sistemi di ancoraggio

Codice	Prodotto	U.m.	Conf.	M	L	C/R nastro	kN
40010035	mm 35 kg 3000 gancio uncino	nr	10	35	1,3+2,7	3.000	15

A richiesta con nastro di altri colori e altre lunghezze



quaranta

→ sistemi di ancoraggio, cricchetti e ganci

35 mm

40

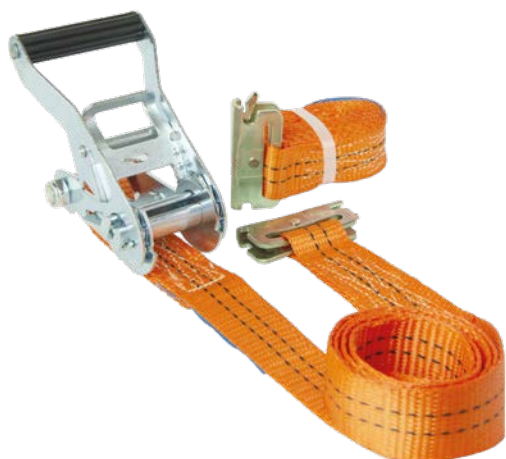

40.01 Sistemi di ancoraggio gancio tendex EN 12195-2

Codice	Prodotto	U.m.	Conf.	M	L	C/R nastro	kN
40010235	mm 35 kg 3000 gancio tendex	nr	10	35	1,3+2,7	3.000	15

A richiesta con nastro di altri colori e altre lunghezze

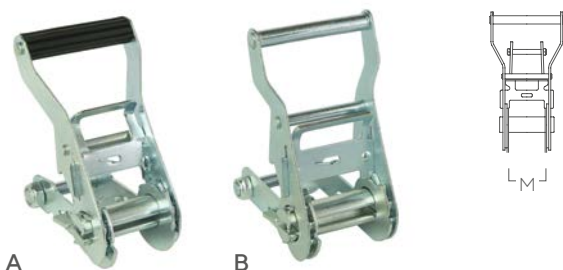

40.03 Cricchetti

Codice	Prodotto	U.m.	Conf.	M	Kg	kN
40033500	mm 35 kg 3000 f.z.	A	nr	10	35	3.000 15
40033501	mm 35 kg 2000 f.z.	B	nr	10	35	2.000 10



Codice	Prodotto	U.m.	Conf.	M	Kg	kN
40033501AI	mm 35 kg 2000 acciaio inox 304	C	nr	10	35	2.000 10

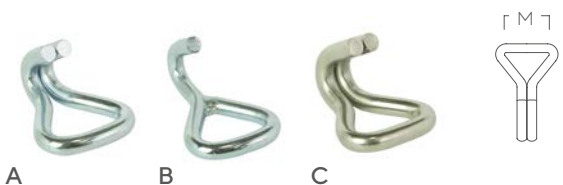

40.05 Ganci uncino

Codice	Prodotto	U.m.	Conf.	M	Kg
40050035	mm 35 2 dita	A	nr	10	35 3.000
40050036	mm 35 1 dito	B	nr	10	35 2.000
40050035AI	mm 35 2 dita acciaio inox 304	C	nr	10	35 2.000



quaranta

→ sistemi di ancoraggio, cricchetti e ganci

35 mm

40

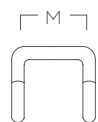

40.05 Ganci sponda

Codice	Prodotto	U.m.	Conf.	M	Kg	filo
40050135	mm 35	nr	10	35	2.000	8,2

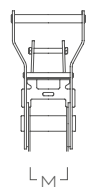

40.01 Sistemi di ancoraggio gancio uncino

Codice	Prodotto	U.m.	Conf.	M	L	C/R cricc.	C/R nastro	kN
40010055	mm 50 nastro blu	nr	10	50	0,5+8,5	5.000	5.000	25
40010057	mm 50 nastro arancio	nr	10	50	0,5+8,5	5.000	5.000	25

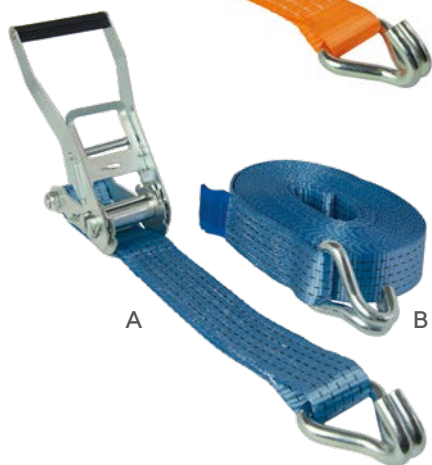

Codice	Prodotto	U.m.	Conf.	M	L	C/R cricc.	C/R nastro	kN
40010060	mm 50 nastro blu	nr	10	50	0,5+8,5	5.000	7.500	25

Codice	Prodotto	U.m.	Conf.	M	L	C/R cricc.	C/R nastro	
40018605	solop. corta mm 50	A	nr	10	50	0,5	5.000	5.000
40018606	solop. corta mm 50	A	nr	10	50	0,5	5.000	7.500
400196085	solop. lunga mm 50	B	nr	10	50	8,5	5.000	5.000
400196086	solop. lunga mm 50	B	nr	10	50	8,5	5.000	7.500

A richiesta con nastro di altri colori e altre lunghezze



quaranta

→ sistemi di ancoraggio, cricchetti e ganci

50 mm

40



40.01 Sistemi di ancoraggio gancio sponda EN 12195-2

Codice	Prodotto	U.m.	Conf.	M	L	C/R cricc.	C/R nastro	kN
40010155	mm 50 nastro blu	nr	10	50	0,5+8,5	5.000	5.000	25
40010157	mm 50 nastro arancio	nr	10	50	0,5+8,5	5.000	5.000	25

Codice	Prodotto	U.m.	Conf.	M	L	C/R cricc.	C/R nastro	kN
40010160	mm 50 nastro blu	nr	10	50	0,5+8,5	5.000	7.500	25

A richiesta con nastro di altri colori e altre lunghezze



40.01 Sistemi di ancoraggio gancio uncino EN 12195-2

Codice	Prodotto	U.m.	Conf.	M	L	C/R cricc.	C/R nastro	kN
40010067ERG	mm 50 ERGO nastro arancio	nr	10	50	0,5+8,5	5.000	7.500	25

A richiesta con nastro di altri colori e altre lunghezze

A richiesta con altri ganci



quaranta

→ sistemi di ancoraggio e sollevamento

50 mm

40



40.01 Sistemi di ancoraggio gancio tendex EN 12195-2

Codice	Prodotto	U.m.	Conf.	M	L	C/R cricc.	C/R nastro	kN
40010250	mm 50	nr	10	50	0,5+3,5	5.000	5.000	25

Codice	Prodotto	U.m.	Conf.	M	L	C/R cricc.	C/R nastro	kN
40010250L	mm 50	nr	10	50	0,5+3,5	2.000	5.000	10

A richiesta con nastro di altri colori e altre lunghezze



40.01 Sistemi di ancoraggio asola rinforzata EN 12195-2

Codice	Prodotto	U.m.	Conf.	M	L	C/R cricc.	C/R nastro	kN
40016041	mm 50 nastro rosso	nr	10	50	1+4	5.000	5.000	25
40016051	mm 50 nastro rosso	nr	10	50	1+5	5.000	5.000	25
40016061	mm 50 nastro rosso	nr	10	50	1+6	5.000	5.000	25

A richiesta con nastro di altri colori e altre lunghezze



quaranta

→ sistemi di ancoraggio
e sollevamento

40

50 mm



40.02 Protezione angolare

Codice	Prodotto	U.m.	Conf.	M
40025000	mm 100 pvc per nastro poliesteri mm 50	nr	50	100



40.03 Cricchetti

Codice	Prodotto	U.m.	Conf.	M	Kg	kN
40035000	mm 50 kg 5000 f.z.	nr	10	50	5.000	25



Codice	Prodotto	U.m.	Conf.	M	Kg	kN
40035001	mm 50 kg 2000 f.z.	nr	10	50	2.000	10



Codice	Prodotto	U.m.	Conf.	M	Kg	kN
40035000AI	mm 50 kg 4000 acciaio inox 304	nr	10	50	3.000	20
40035002AI	mm 50 kg 2000 compatto acciaio inox 304	nr	10	50	2.000	10



Codice	Prodotto	U.m.	Conf.	M	Kg	kN
40035002	mm 50 kg 5000 f.z. senza maniglia	nr	10	50	5.000	25
40035002M	maniglia mm 50 per 40035002	nr	1	50		



quaranta

→ sistemi di ancoraggio e sollevamento

50 mm

40



40.03 Cricchetti

Codice	Prodotto	U.m.	Conf.	M	Kg	kN	
40035003	mm 50 kg 5000 leva corta	A	nr	10	50	5.000	25

Codice	Prodotto	U.m.	Conf.	M	Kg	kN	
40035004	mm 50 kg 5000 ERGO caricamento inverso	B	nr	10	50	5.000	25



Codice	Prodotto	U.m.	Conf.	M	Kg	kN	
40035008	mm 50 kg 5000 maniglia lunga STF 450 daN	C	nr	10	50	5.000	25



Codice	Prodotto	U.m.	Conf.	M	Kg	kN	
40035009	mm 50 kg 5000 doppia cremagliera maniglia ricoperta in pvc nero	D	nr	10	50	5.000	25

40.03 Cricchetti con gancio applicato



Codice	Prodotto	U.m.	Conf.	M	Kg
40035005	mm 50 kg 4000 f.z. senza maniglia con gancio bisarca applicato	nr	10	50	4.000
40035002M	maniglia	nr	1	50	



quaranta

→ sistemi di ancoraggio
e sollevamento

50 mm

40



40.05 Ganci uncino

Codice	Prodotto	U.m.	Conf.	M	Kg	filo
40050050	mm 50 2 dita	nr	10	50	5.000	10
40050050Al	mm 50 acciaio inox 304 2 dita	nr	10	50	5.000	11,5
40050055	mm 50 2 dita filo 7 mm	nr	10	50	1.500	7



Codice	Prodotto	U.m.	Conf.	M	Kg	filo
40050051	mm 50 1 dito filo 15mm	nr	10	50	5.000	15



Codice	Prodotto	U.m.	Conf.	M	Kg
40050053	mm 50 con sicura	nr	10	50	5.000



Codice	Prodotto	U.m.	Conf.	M	Kg
40050054	mm 50 piatto	nr	10	50	2.700



Codice	Prodotto	U.m.	Conf.	M
40050056	mm 50 con tubo	nr	10	50

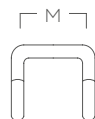

40.05 Gancio sponda

Codice	Prodotto	U.m.	Conf.	M	Kg	filo
40050150	mm 50	nr	10	50	5.000	11,2



quaranta

→ sistemi di ancoraggio
e sollevamento

50 mm

40

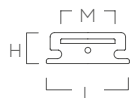

40.05 Tendex

Codice	Prodotto	U.m.	Conf.	M	Kg	L	H
40050250	mm 50	nr	10	52	2.000	73	30

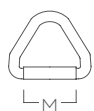

40.05 Triangoli

Codice	Prodotto	U.m.	Conf.	M	Kg	filo
40050350	piatto filo mm 15	nr	10	50	5.000	15



Codice	Prodotto	U.m.	Conf.	M	Kg	filo
40050351	filo tondo mm 7,5	nr	10	50	2.000	7,5



Codice	Prodotto	U.m.	Conf.	M	Kg	filo
40050352	filo tondo mm 11	nr	10	50	2.500	11



40.05 Ganci bisarca

Codice	Prodotto	U.m.	Conf.	M	Kg
40050650	mm 50	nr	10	50	5.000



quaranta

→ sistemi di ancoraggio
e sollevamento

50 mm

40



40.05 Ganci cargo

Codice	Prodotto	U.m.	Conf.	M	Kg
40050660	piatto mm 50 con sicura	nr	10	50	5.000

Codice	Prodotto	U.m.	Conf.	M	Kg
40050661	girato mm 50 con sicura	nr	10	50	5.000



40.05 Ganci per Prontocar

Codice	Prodotto	U.m.	Conf.	M	Kg
40050670	moschettone mm 50 con sicura	nr	10	50	1.500



40.05 Ganci a perdere

Codice	Prodotto	U.m.	Conf.	M	Kg
40050700	mm 50	nr	10	50	2.000

A richiesta cricchetto



quaranta

→ sistemi di ancoraggio
e sollevamento

75 mm

40

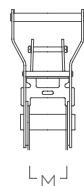

40.03 Cricchetti

Codice	Prodotto	U.m.	Conf.	M	Kg	kN
40037500	mm 75 kg 10.000 f.z.	nr	10	75	10.000	45



40.05 Ganci uncino

Codice	Prodotto	U.m.	Conf.	M	Kg	filo
40050075	mm 75 2 dita	nr	10	50	10.000	15



Formato tipico
dell'etichetta
Sistemi di ancoraggio

Portata della cinghia	LC daN	Sezione B
Carico di trazione normalizzato	$S_{HF} 50 \text{ daN} / S_{TF} \dots \dots \text{ daN}$	
Materiale della rete		
Lunghezza (L_G , L_{GF} o L_{GL} , se pertinente)	L "Non per il sollevamento!"	
Nome del fabbricante o del fornitore, relativo simbolo, marchio commerciale registrato o altra identificazione non ambigua		
Codice di tracciabilità del fabbricante		Sezione A
Anno di fabbricazione		
Numero della norma	EN 12195-2	
Portata della cinghia	LC daN	
Materiale della rete		
Fornitore		
Codice di tracciabilità del fabbricante		
Anno di fabbricazione		
Numero della norma	EN 12195-2	

Tutte le cinghie a cricchetto devono essere utilizzate solo ed esclusivamente per operazioni di **ancoraggio**, mai di sollevamento.

LC (lashing capacity) indica la capacità di ancoraggio misurata daN

SHF indica il valore di pretensionamento esercitato dalla forza manuale dopo l'azionamento del cricchetto

STF è la forza residua fissata al 10% della capacità di carico (LC)

Normativa di riferimento EN-12195-2

L'etichetta è un elemento indispensabile che descrive i diversi valori e codici determinati dalla normativa EN 12195-2

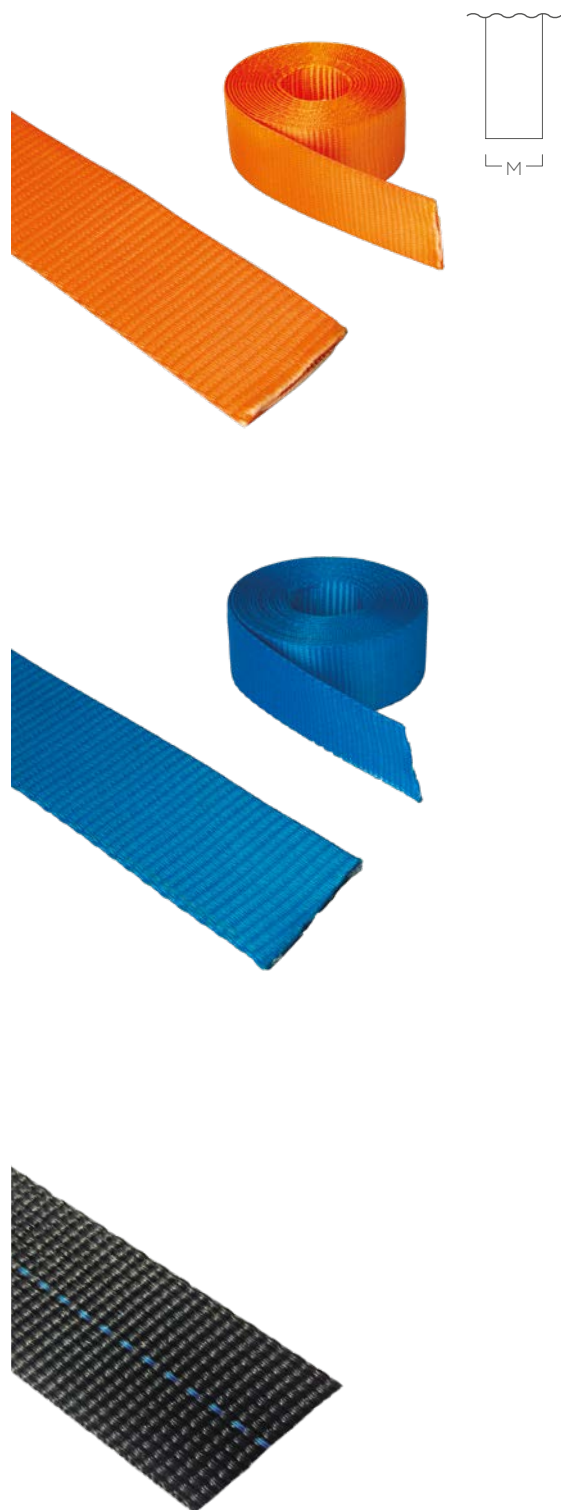

13.70 Nastri poliestere per ancoraggio

Codice	Prodotto	U.m.	Conf.	M
13700604	mm 6 nero	ml	100	6
13701500	mm 15 bianco kg 500	ml	100	15
13701504	mm 15 nero kg 500	ml	100	15
13702000	mm 20 kg 700 bianco	ml	100	20
13702004	mm 20 kg 700 nero	ml	100	20
13702500	mm 25 kg 800 bianco	ml	100	25
13702501	mm 25 kg 1200 bianco	ml	100	25
13702504	mm 25 kg 1200 nero	ml	100	25
13702505	mm 25 kg 1300 bianco riga rossa	ml	100	25
13702510	mm 25 kg 1200 blu	ml	100	25
13702520	mm 25 kg 1200 giallo	ml	100	25
13702530	mm 25 kg 1200 grigio	ml	100	25
13702550	mm 25 kg 1200 rosso	ml	100	25
13702560	mm 25 kg 1200 verde	ml	100	25
13702565	mm 25 kg 1200 verde militare	ml	100	25
13702580	mm 25 kg 1200 arancio	ml	100	25
13703000	mm 30 kg 2500 bianco	ml	100	30
13703004	mm 30 kg 2500 nero	ml	100	30
13703500	mm 35 kg 3200 bianco	ml	100	35
13703505	mm 35 kg 3300 bianco con riga rossa	ml	100	35
13703510	mm 35 kg 3200 blu	ml	100	35
13703530	mm 35 kg 3200 grigio	ml	100	35
13703540	mm 35 kg 3200 nero	ml	100	35
13703550	mm 35 kg 3200 rosso	ml	100	35
13703560	mm 35 kg 3200 verde militare	ml	100	35
13703580	mm 35 kg 3200 arancio	ml	100	35
13704504	mm 45 kg 2200 nero prontocar	ml	100	45
13704504R	mm 45 kg 2200 nero riga blu prontocar	ml	100	45
13704503	mm 45 kg 2200 grigio prontocar	ml	100	45



quaranta

→ sistemi di ancoraggio
e sollevamento - nastri/brache

40

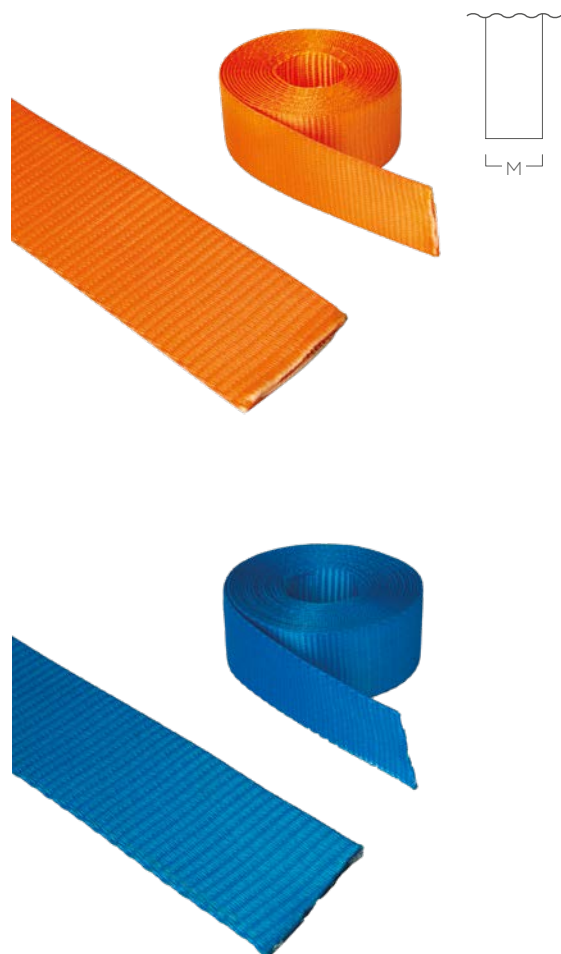

13.70 Nastri poliestere per ancoraggio

Codice	Prodotto	U.m.	Conf.	M
13705000	mm 50 kg 5000 bianco	ml	100	50
13705005	mm 50 kg 5000 bianco con riga rossa	ml	100	50
13705007	mm 50 kg 7500 blu trattato <4%	ml	100	50
13705010	mm 50 kg 5000 blu	ml	100	50
13705020	mm 50 kg 5000 giallo	ml	100	50
13705030	mm 50 kg 5000 grigio	ml	100	50
13705040	mm 50 kg 5000 nero	ml	100	50
13705050	mm 50 kg 5000 rosso	ml	100	50
13705061	mm 50 kg 5000 verde	ml	100	50
13705065	mm 50 kg 5000 verde militare	ml	100	50
13705070	mm 50 kg 5000 marrone	ml	100	50
13705080	mm 50 kg 5000 arancio	ml	100	50
13705086	mm 50 kg 6000 arancio con riga nera	ml	100	50
13705090	mm 50 kg 6000 blu	ml	100	50
13705011	mm 50 kg 7500 blu con riga nera	ml	100	50
13705051	mm 50 kg 7500 rosso con riga nera	ml	100	50





13.70 Nastri poliestere fluorescenti per ancoraggio

Codice	Prodotto	U.m.	Conf.	M
13702520F	mm 25 kg 1200 giallo fluo	ml	100	25
13702580F	mm 25 kg 1200 arancio fluo	ml	100	25
13703580F	mm 35 kg 3500 arancio fluo	ml	100	35

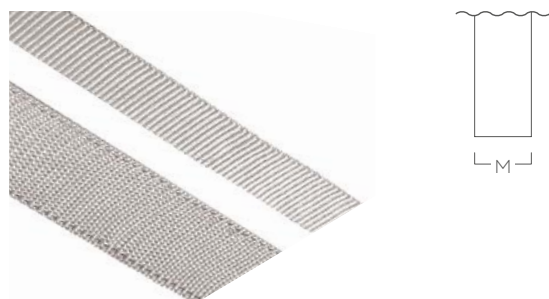

13.75 Nastri poliestere per sollevamento

Codice	Prodotto	U.m.	Conf.	M
13750050	mm 50 kg 7500 bianco	ml	100	50
13750060	mm 60 kg 8500 bianco	ml	100	60
13750075	mm 75 kg 11250 bianco	ml	100	75
13750100	mm 100 kg 15000 bianco	ml	100	100



quaranta

→ sistemi di ancoraggio
e sollevamento - nastri

40



45.70 Brache - Cinghie piatte a nastro doppio per sollevamento



Codice	Prodotto	Verticale	Canestro	Canestro 45°	Canestro 60°	Cappio
4570B01T	mm 50 - viola	1000	2000	1400	1000	800
4570B02T	mm 60 - verde	2000	4000	2800	2000	1600
4570B03T	mm 90 - giallo	3000	6000	4200	3000	2400
4570B04T	mm 120 - grigio	4000	8000	5600	4000	3200
4570B05T	mm 150 - rosso	5000	10000	7000	5000	4000
4570B06T	mm 180 - marrone	6000	12000	8400	6000	4800
4570B08T	mm 240 - blu	8000	16000	11200	8000	6400
4570B10T	mm 300 - arancio	10000	20000	14000	10000	8000

Per misure disponibili contattare i nostri uffici commerciali



45.70 Nastri poliestere per sollevamento (tipo brache)

Codice	Prodotto	U.m.	Conf.	M
45700500	mm 50 kg 4500 viola	ml	100	50
45700600	mm 60 kg 9000 verde	ml	100	60
45700900	mm 90 kg 13500 giallo	ml	100	90
45701200	mm 120 kg 18000 grigio	ml	100	120
45701500	mm 150 kg 22500 rosso	ml	100	150
45701800	mm 180 kg 30000 marrone	ml	100	180
45702400	mm 240 kg 40000 blu	ml	100	240
45703000	mm 300 kg 50000 arancio	ml	100	300



LINEA HOBBY

SOLUZIONI PER L'ANCORAGGIO

NASTRI CON FIBBIA ZAMA 25/35 mm

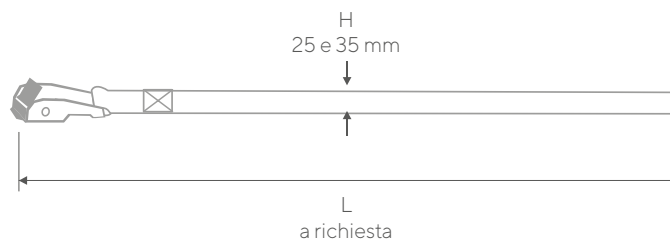

CRICCHETTO 25 mm

Disponibile con gancio "S", con gancio "Uncino" o senza ganci

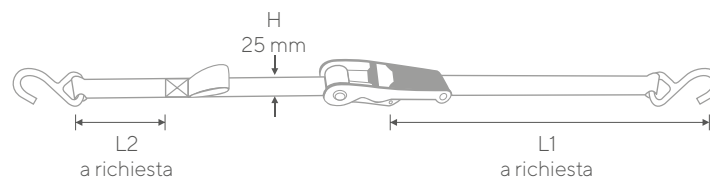

Per disponibilità contattare i nostri uffici commerciali



/
QUARANTACINQUE

Sistemi di tensionamento



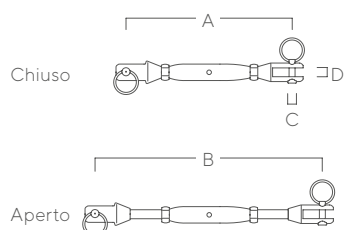

45.01 Tenditore a 2 forcelle acciaio inox
AISI 316

Codice	U.m.	Conf.	Mis.	Fune Ø	A	B	C	D
450106AI	nr	10	6	3	135	190	5	6
450108AI	nr	10	8	4	160	220	7	8
450110AI	nr	10	10	5	185	260	8	10
450112AI	nr	10	12	6-7	250	365	10	12

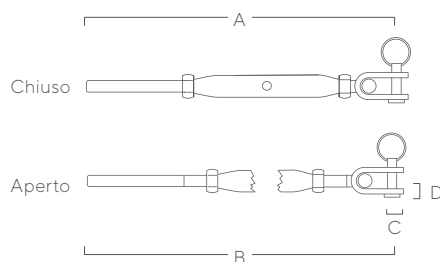

45.02 Tenditore con snodo e terminale a pressare
AISI 316

Codice	U.m.	Conf.	Mis.	Fune Ø	A	B	C	D
450206AI	nr	10	6	3	150	200	6	8
450208AI	nr	10	8	4	190	250	8	10
450210AI	nr	10	10	5	235	305	10	12
450212AI	nr	10	12	6	310	410	12	14

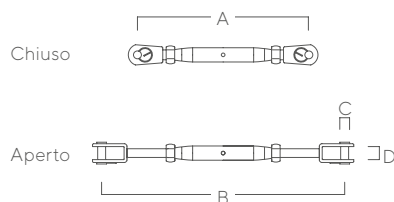

45.05 Tenditore a 2 forcelle saldate acciaio inox
AISI 316

Codice	U.m.	Conf.	Mis.	Fune Ø	A	B	C	D
450506AI	nr	10	6	3	135	200	6	11
450508AI	nr	10	8	4	145	210	6	11
450510AI	nr	10	10	5	180	250	8	13
450512AI	nr	10	12	6-7	210	300	12	12

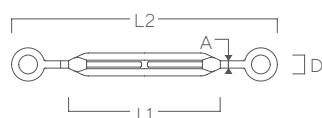

45.08 Tenditore a 2 occhi acciaio inox
AISI 316

Codice	U.m.	Conf.	Mis.	A	D	L1	L2
450806AI	nr	10	6	6	10	90	140÷220
450808AI	nr	10	8	8	14	120	180÷280
450810AI	nr	10	10	10	16	150	230÷360
450812AI	nr	10	12	12	18	200	280÷460



quarantacinque

→ sistemi di tensionamento inox

A richiesta f.z.

45

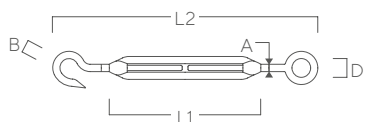

45.09 Tenditori occhio e gancio occhi acciaio inox AISI 316

Codice	U.m.	Conf.	Mis.	A	B	D	L1	L2
450906AI	nr	10	6	6	10	10	90	140÷220
450908AI	nr	10	8	8	11	14	120	180÷280
450910AI	nr	10	10	10	12	16	150	230÷360
450912AI	nr	10	12	12	14	18	200	280÷460

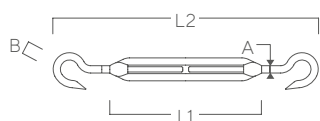

45.10 Tenditori a 2 ganci acciaio inox AISI 316

Codice	U.m.	Conf.	Mis.	A	B	L1	L2
451006AI	nr	10	6	6	10	90	140÷220
451008AI	nr	10	8	8	11	120	180÷280
451010AI	nr	10	10	10	12	150	230÷360
451012AI	nr	10	12	12	14	200	280÷460

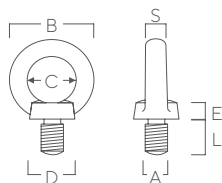

45.12 Golfari maschi acciaio inox AISI 316

Codice	U.M.	Conf.	A	B	C	D	E	L	S	S.W.L. (kg)			(*) Nm
										0°	45°	90°	
451206AI	nr	10	6	36	20	20	6	13	8	90	60	45	3,5
451208AI	nr	10	8	36	20	20	6	13	8	140	100	70	8
451210AI	nr	10	10	45	25	25	8	17	10	230	170	115	16
451212AI	nr	10	12	54	30	30	10	20,5	12	340	240	170	28
451214AI	nr	10	14	54	30	30	10	20,5	12	500	350	250	45

(*) Coppia max di serraggio



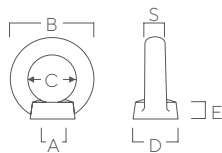

45.13 Golfari femmina acciaio inox AISI 316

Codice	U.M.	Conf.	A	B	C	D	E	S	S.W.L. (kg)			(*) Nm
									0°	45°	90°	
451306AI	nr	10	6	36	20	20	8,5	8	90	60	45	3,5
451308AI	nr	10	8	36	20	20	8,5	8	140	100	70	8
451310AI	nr	10	10	45	25	25	10	10	230	170	115	16
451312AI	nr	10	12	54	30	30	11	12	340	240	170	28
451314AI	nr	10	14	54	30	30	11	12	500	350	250	45

(*) Coppia max di serraggio

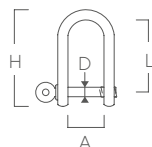

45.21 Grilli dritti con chiave acciaio inox AISI 316

Codice	U.m.	Conf.	Mis.	D	A	L	H
452106AI	nr	10	6	6	14	26	37
452108AI	nr	10	8	8	16	32	48
452110AI	nr	10	10	10	20	45	64
452112AI	nr	10	12	12	25	48	72

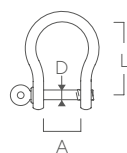

45.22 Grilli a cuore acciaio inox AISI 316

Codice	U.m.	Conf.	Mis.	D	A	L
452206AI	nr	10	6	6	14	24
452208AI	nr	10	8	8	16	32
452210AI	nr	10	10	10	20	40
452212AI	nr	10	12	12	26	48



quarantacinque

→ sistemi di tensionamento inox

A richiesta f.z.

45

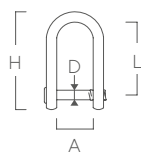

45.23 Grilli dritti acciaio inox con perno a brugola AISI 316

Codice	U.m.	Conf.	Mis.	D	A	L	H	brugola
452306AI	nr	10	6	6	14	26	37	3
452308AI	nr	10	8	8	16	32	48	3
452310AI	nr	10	10	10	20	45	64	5
452312AI	nr	10	12	12	25	48	72	6

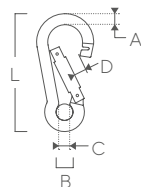

45.31 Moschettoni con anello acciaio inox AISI 316

Codice	U.m.	Conf.	Mis.	A	B	D	L
453104AI	nr	10	40	4	4,5	6	40
453105AI	nr	10	50	5	7	7	50
453106AI	nr	10	60	6	8	8	60
453107AI	nr	10	70	7	9	9	70
453108AI	nr	10	80	8	10,5	11	80
453109AI	nr	10	90	9	12	12	90
453110AI	nr	10	100	10	14	13	100

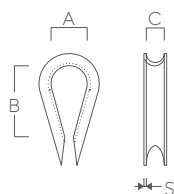

45.50 Redance Din 6899A acciaio FE 360 B

Codice	U.m.	Conf.	Mis.	A	B	C	S
455005FE	nr	10	5	14	30	6	1
455006FE	nr	10	6	15	33	7	1
455008FE	nr	10	8	18	39	9	1,25
455010FE	nr	10	10	22	47,5	11	1,5
455012FE	nr	10	12	26	56,5	13	1,5



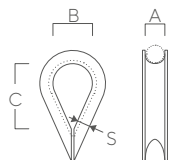

45.52 Redance in acciaio inox

AISI 316

Codice	U.m.	Conf.	Mis.	A	B	C	S
455205AI	nr	10	5	5	14	20	1,2
455206AI	nr	10	6	6	15	23	1,2
455208AI	nr	10	8	8	18	29	1,5
455210AI	nr	10	10	10	24	37	1,5
455212AI	nr	10	12	12	29	50	1,5

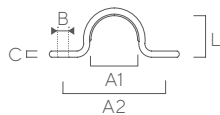

45.53 Ponticelli acciaio inox

Codice	U.m.	Conf.	Mis.	L	A2	A1	B	C
455310AI	nr	10	10x11	10	30	11	4,2	1,5
455313AI	nr	10	13x15	13	34	15	5,2	2
455317AI	nr	10	17x20	17	40	20	5,2	3

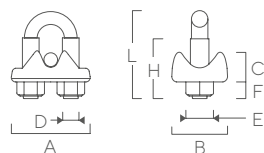

45.54 Morsetti a cavalletto acciaio inox

AISI 316

Codice	U.m.	Conf.	Mis.	A	B	C	E	F	H	L	D
455404AI	nr	10	3-4	22	14	8	7	3,5	12	22	4
455405AI	nr	10	5	24	16	9	8	4	15	24	5
455406AI	nr	10	6	30	18	11	10	5	18	33	6
455408AI	nr	10	8	33	20	12	10	5	20	35	6
455410AI	nr	10	10	37	22	14	13	6,5	22	43	8



quarantacinque

→ sistemi di tensionamento inox

A richiesta f.z.

45

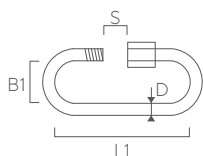

45.44 Maglie rapide acciaio inox

AISI 316

Codice	U.m.	Conf.	D	L1	B1	S
454403AI	nr	10	3,5	29	10	4,5
454404AI	nr	10	4	32	12	5,5
454405AI	nr	10	5	39	13	6,5
454406AI	nr	10	6	45	14	7,5
454407AI	nr	10	7	52	16	8,5
454408AI	nr	10	8	58	18	9,5
454409AI	nr	10	9	62	20	11,0
454410AI	nr	10	10	69	22	12,0
454412AI	nr	10	12	81	24	14,5

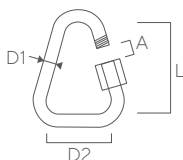

45.66 Maglie rapide triangolari

FERRO

Codice	U.m.	Conf.	Mis.	A	D1	D2	L
4566006F	nr	10	6	7,5	6	35	44
4566008F	nr	10	8	10	8	40	57
4566010F	nr	10	10	12	10	46	67
4566012F	nr	10	12	15	12	51	80

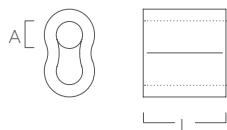

45.55 Manicotti in rame e alluminio per pressature

Codice	U.m.	Conf.	Mis.	A	D1	D2
455506RA	nr	10	6	7	22	rame
455508RA	nr	10	8	9,5	27	rame
455510RA	nr	10	10	11,5	33	rame
455506AL	nr	10	6	7	22	alluminio
455508AL	nr	10	8	9,5	27	alluminio
455510AL	nr	10	10	11,5	33	alluminio



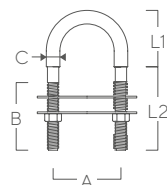
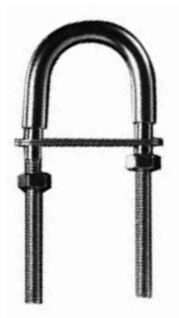

45.56 Cavallotti ad "U" acciaio inox AISI 316

Codice	U.m.	Conf.	Mis.	A	B	C	L1	L2
455604AI	nr	10	M4x62	30	30	6	25	37
455605AI	nr	10	M5x78	35	40	7	30	48
455606AI	nr	10	M6x90	35	45	8	35	55
455608AI	nr	10	M8x100	35	52	10	38	62
455609AI	nr	10	M8x120	45	62	10	47	73
455610AI	nr	10	M10x130	50	60	12	55	75
455612AI	nr	10	M12x150	60	65	14	65	85

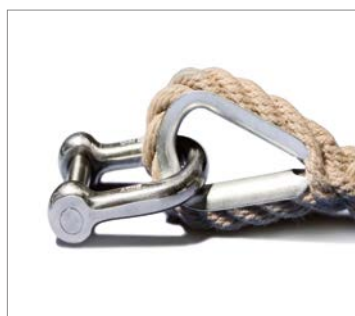



45.60 Cavi acciaio inox AISI 316 · 6x19+WSC (133 fili)

EN12385-4

Codice	WSC=anima metallica	Ø mm	peso kg/m	carico di rottura min*
456003AI	Cavo mm 03/133 fili acciaio inox 316	3	0,034	5,12
456004AI	Cavo mm 04/133 fili acciaio inox 316	4	0,061	9,09
456005AI	Cavo mm 05/133 fili acciaio inox 316	5	0,095	14,21
456006AI	Cavo mm 06/133 fili acciaio inox 316	6	0,137	20,46
456008AI	Cavo mm 08/133 fili acciaio inox 316	8	0,244	36,37
456010AI	Cavo mm 10/133 fili acciaio inox 316	10	0,381	56,83
456012AI	Cavo mm 12/133 fili acciaio inox 316	12	0,549	81,84

A richiesta cavo 49 fili acciaio inox

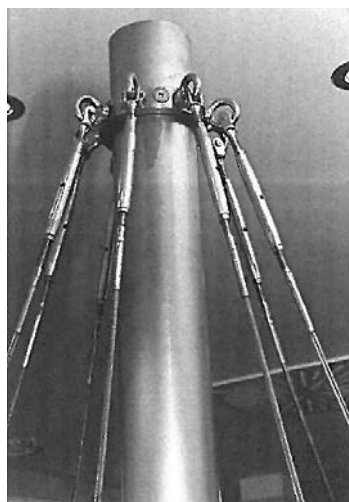

45.62 Cavo antigiro 19x7 acciaio zincato 19x(1+6)

EN12385-4

Codice	133 fili antigiro parall. · crociata destra	Ø mm	peso kg/m	carico di rottura min*
456203AZ	Cavo antigiro mm 03/133 fili acciaio zincato	3	0,036	5,79
456204AZ	Cavo antigiro mm 04/133 fili acciaio zincato	4	0,064	10,29
456205AZ	Cavo antigiro mm 05/133 fili acciaio zincato	5	0,1	16,07
456206AZ	Cavo antigiro mm 06/133 fili acciaio zincato	6	0,144	23,14
456208AZ	Cavo antigiro mm 08/133 fili acciaio zincato	8	0,257	41,14
456210AZ	Cavo antigiro mm 10/133 fili acciaio zincato	10	0,401	64,29
456212AZ	Cavo antigiro mm 12/133 fili acciaio zincato	12	0,577	92,57

* CARICO DI ROTTURA MIN.[MBL] R1960 N/mm² · Kn (1Kn=101,97KG)



Diametro mm	C.R kg teorico	peso gr/mtl	rotolo metri
1	150	1	200
1,3	220	1,5	200
1,5	300	2	200
2	450	2,5	100
2,5	600	4	100
3	750	5	100
4	1400	8	100
5	2400	14	100
6	3300	20	100
7	3800	28	100
8	4800	38	100
9	6400	50	100
10	8200	59	100
12	10000	90	100
14	14000	120	100
16	22100	160	100
18	27000	210	100
20	32400	250	100

Diametro mm	C.R kg teorico	peso gr/mtl	rotolo metri
1,5	120	2	100
1,8 *	180	2,5	100
2	240	3,3	100
2,5	320	4,6	100
3	500	9,6	100
4	600	10	100
5	850	19	100
6	1500	24	100
7	1800	32	100
8	2400	43	100
10	3500	64	100
12	5000	94	100
14	6500	118	100
16	8800	148	100
6,2	1800	21	100

* specifico per "optimist" lavorazione granita

11.45 Trecce speciali solo su richiesta



Codice	Prodotto	U.m.
1145820000	DYNAPROTECT	ml a richiesta

Tipo: treccia a 12 fusi senz'anima interna.

Composizione: fibra 100% Dyneema® SK 75 (marchio registrato DSM), con impregnazione protettiva in resina uretanica colorata.

Caratteristiche: liscia senz'anima (lavorazione LSA) super leggera, altissima tenacità, praticamente inestensibile, facilmente impalmabile.

Allungamento: da 0,4% a 0,5% con un carico di lavoro pari al 20% del carico di rottura.

Classe: inestensibile.

Colore: azzurra o nera.

Utilizzo e impiego: scotta e drizza da regata e per cavo verricelli dei fuoristrada (nei diametri 8-9-10-12).



Codice	Prodotto	U.m.
1145335000	doppia DYNAPLAM COLORATA	ml a richiesta

Tipo: doppia treccia a 16, 24 fusi liscia.

Composizione: calza esterna in fibra di poliestere alta tenacità a torsioni contrapposte, calza intermedia in fiocco di poliestere antiscivolo (per i diametri da mm. 5 in poi), anima interna intrecciata in Dyneema® SK 75 (marchio registrato DSM).

Caratteristiche: leggera, praticamente inestensibile, impalmabile. Il tipo diametro mm. 5,1 è realizzato aumentando la percentuale di anima interna ottenendo così una treccia a elevate prestazioni per il carico di rottura.

Allungamenti: da 3% a 4% alla rottura.

Classe: inestensibile.

Colore: bianca, nera, rossa, blu, azzurro royal, verde, gialla, tutte con/senza segnalino colorato.

Utilizzo e impiego: scotte e drizze per usi estremi e regate, come sagola per fucili sub (nei diametri mm. 1,5-2-2,5), come stroppini per optimist (nel diametro mm. 1,8 lavorazione granita) e come treccino da montagna ad alte prestazioni (nei diametri mm. 4 e 5).





Diametro mm	C.R kg teorico	peso gr/mtl	rotolo metri
0,79	191	3200	500
0,94	275	2100	500
1,09	320	1500	500
1,19	370	1250	500



Diametro mm	C.R kg teorico	peso gr/mtl	rotolo metri
9	1800	55	200
10,5	2825	75	200
10,5*	2700	75	200
11	2900	82	200
12	3100	95	200

* Certificato EN 1891:1998

11.45 Trecce speciali solo su richiesta

Codice	Prodotto	U.m.
1145714000	rafforzino nylon bianco	ml a richiesta

Tipo: 3 capi doppia torsione Z-S.

Composizione e caratteristiche: nylon alta tenacità ritorto a doppia torsione termofissato cerato (disponibile in diverse versioni).

Colore: bianco.

Utilizzo e impiego: pesca, nautica, tappezzeri, materassai e usi tessili in genere.

Codice	Prodotto	U.m.
1145815000	treccia statica per speleologia	ml a richiesta

Tipo: treccia a 32 fusi granita.

Composizione: multifibra di nylon 100% alta tenacità.

Caratteristiche: anima termofissata gherlino con torsioni contrapposte antigiro.

Classe: alpinismo/speleologia.

Colore: standard, bianca con doppio segnalino nero.

Utilizzo e impiego: treccia statica da speleologia e per usi industriali quali lavori in parete, disaggi, giardinaggio, funi anticaduta e di sicurezza per lavori edili ed in quota. Corrispondente EN 1891.



Diametro mm	C.R kg teorico	peso gr/mtl
2,8	420	bobina 200 m
3,5	750	bobina 200 m
4	1080	bobina 200 m
10	3400	matassa 20 m
10	2700	matassa 20 m 1 redance *
10	2700	matassa 20 m 2 redance *

* in acciaio inox impalmata a mano



Diametro mm	C.R kg teorico	peso gr/mtl	rotolo metri
1,5	80	2	100
2	180	3,5	100
2,5	220	5	100
3	300	8	100
4	400	12	100
5	650	21	100
6	950	25	100
8	-	30	100
5,5	1400	-	100
6,2 *	1650	27	100

* Certificato EN 564:2006

11.45 Trecce speciali solo su richiesta

Codice	Prodotto	U.m.
1145830000	trecchia Kelafire antincendio	ml a richiesta

Tipo: trecchia a 16 fusi liscia senz'anima.

Composizione: fibra 100% Kevlar® (marchio registrato Dupont International).

Caratteristiche: antincendio resistente al fuoco. Prodotta nel diametro standard mm. 10 (a richiesta diametro mm. 8,5 e 12). Carico di rottura dinamometrico minimo garantito della fune Kg. 3.400 ca., mentre sulle asole impalmate Kg. 2.700 ca. Temperatura di decomposizione termica tra i 427 e i 482 gradi C.

Temperatura massima di utilizzo 350 gradi C. Tenacità residua dopo 10 ore di esposizione a 250 gradi C. circa 80%.

Classe: ignifuga.

Colore: naturale gialla.

Utilizzo e impiego: per attrezzature antincendio e dotazioni obbligatorie di sicurezza VV. FF.

Codice	Prodotto	U.m.
1145340000	doppia trecchia Kelaplam	ml a richiesta

Tipo: doppia trecchia a 16, 24 fusi liscia.

Composizione: calza esterna in fibra di poliestere alta tenacità a torsioni contrapposte, anima interna intrecciata in fibra in Kevlar® 29 originale (marchio registrato Dupont International).

Caratteristiche: leggera, praticamente inestensibile e facilmente impalmabile.

Classe: inestensibile.

Colore: bianca o nera (multicolor fantasy solo nel diametro mm. 6.2).

Utilizzo e impiego: scotte e drizze per usi estremi e regate, come sagola per fucili sub (nei diametri mm. 1,5-2-2,5), come stroppini per optimist (nel diametro mm. 1,5 lavorazione granita) e come cordino da montagna ad alte prestazioni (nei diametri mm. 4 - 5 e 6,2).





45.70 Brache - Cinghie piatte a nastro doppio per sollevamento solo su richiesta



Codice	Prodotto	Verticale	Canestro	Canestro 45°	Canestro 60°	Cappio
4570B01T	mm 50 - viola	1000	2000	1400	1000	800
4570B02T	mm 60 - verde	2000	4000	2800	2000	1600
4570B03T	mm 90 - giallo	3000	6000	4200	3000	2400
4570B04T	mm 120 - grigio	4000	8000	5600	4000	3200
4570B05T	mm 150 - rosso	5000	10000	7000	5000	4000
4570B06T	mm 180 - marrone	6000	12000	8400	6000	4800
4570B08T	mm 240 - blu	8000	16000	11200	8000	6400
4570B10T	mm 300 - arancio	10000	20000	14000	10000	8000

Per misure disponibili contattare i nostri uffici commerciali



45.70 Nastri poliestere per sollevamento (tipo brache)

Codice	Prodotto	U.m.	Conf.	M
45700500	mm 50 kg 4500 viola	ml	100	50
45700600	mm 60 kg 9000 verde	ml	100	60
45700900	mm 90 kg 13500 giallo	ml	100	90
45701200	mm 120 kg 18000 grigio	ml	100	120
45701500	mm 150 kg 22500 rosso	ml	100	150
45701800	mm 180 kg 30000 marrone	ml	100	180
45702400	mm 240 kg 40000 blu	ml	100	240
45703000	mm 300 kg 50000 arancio	ml	100	300



/
CINQUANTA

Sistema Prontocar

50

cinquanta

→ sistema prontocar

50



50.03 Prontocar acciaio inox scatto

Codice	Prodotto	U.m.	Conf.	L	Kg
50031750	gancio uncino chiuso f.z.	nr	50	70,0	1.400



50.03 Prontocar acciaio inox scatto gancio metal 50150010

Codice	Prodotto	U.m.	Conf.	L	Kg
50031751	gancio metal acciaio inox nastro nero	nr	50	70,0	1.400
50031751*	gancio metal acciaio inox 304 nastro nero	nr	50	70,0	1.400

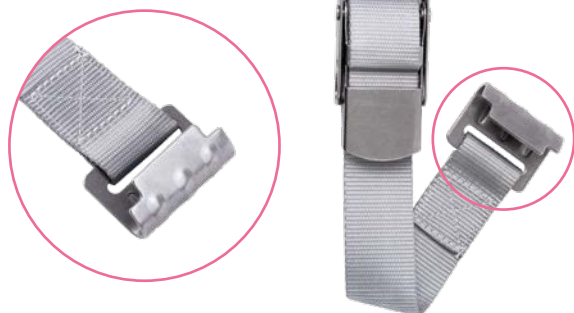

Codice	Prodotto	U.m.	Conf.	L	Kg
50031751G	gancio metal acciaio inox nastro grigio	nr	50	70,0	1.400



Codice	Prodotto	U.m.	Conf.	L	Kg
50031751H	gancio metal acciaio inox nastro nero con riga blu	nr	50	70,0	1.400



cinquanta

→ sistema prontocar

50



50.03 Prontocar acciaio inox scatto gancio metal 50150011

Codice	Prodotto	U.m.	Conf.	L	Kg
50031751K	gancio metal K acciaio inox nastro nero	nr	50	70,0	1.400
50031754G	gancio metal K acciaio inox nastro grigio	nr	50	70,0	1.400





50.03 Prontocar acciaio inox molla

Codice	Prodotto	U.m.	Conf.	L	Kg
50031752	gancio uncino chiuso f.z.	nr	50	70,0	1.400



50.03 Prontocar acciaio inox molla gancio metal 50150010

Codice	Prodotto	U.m.	Conf.	L	Kg
50031753	gancio metal acciaio inox	nr	50	70,0	1.400



50.03 Prontocar acciaio inox molla gancio metal 50150010

Codice	Prodotto	U.m.	Conf.	L	Kg
50031753B	gancio uncino metal con freno	nr	50	70,0	1.400



cinquanta

→ sistema prontocar

50



50.03 Tenditore inox

Codice	Prodotto	U.m.	Conf.
50039090	senza cinghia con vite di regolazione	nr	50



cinquanta

→ sistema prontocar

50

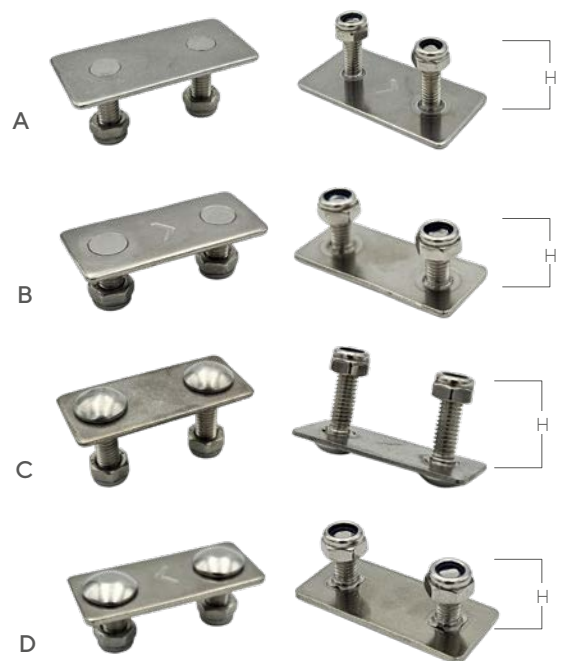

50.12 Piastre fissaggio inox prontocar Interasse mm28

Codice	Prodotto	U.m.	Conf.	H	
50121759	con viti M6 mm 18 e bulloni mm 45x20	A	nr	50	18
50121760	con viti M6 mm 12 e bulloni mm 45x20	B	nr	50	12

Codice	Prodotto	U.m.	Conf.	H	
50121759R	rinforzata con viti M6 mm 18 e bulloni mm 45x20	C	nr	50	18

Codice	Prodotto	U.m.	Conf.	H	
50121760R	rinforzata con viti M6 mm 14 e bulloni mm 45x20	D	nr	50	14



50.12 Piastre fissaggio prontocar Interasse mm28

Codice	Prodotto	U.m.	Conf.	H
50121761	nylon con viti e bulloni per carrucole PSC	nr	50	16



50.12 Piastre fissaggio inox prontocar Interasse mm28

Codice	Prodotto	U.m.	Conf.	Ø foro	
50121762	senza viti mm 48,5x25,50 spessore 1,85	A	nr	50	6,9
50121762L	senza viti mm 45x20 spessore 1,50	B	nr	50	6,5



cinquanta

→ sistema prontocar

50

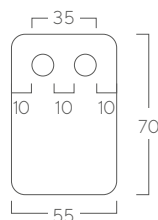
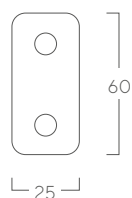

50.12 Piastre fissaggio prontocar

Codice	Prodotto	U.m.	Conf.
50121765	nylon per carrucola int. 28mm	nr	10

Codice	Prodotto	U.m.	Conf.
50121770	nylon per carrucola int. 25 mm	nr	10



09.60 Collare e bulloni a strappo

Codice	Prodotto	U.m.	Conf.
09603534	collare svasato per bullone a strappo d.6,4 alluminio	nr	1.000
09606000	collare per bullone a strappo	nr	1.000
09606432	bullone a strappo d.6,4x32 alluminio	nr	1.000
09606442	bullone a strappo d.6,4x42 alluminio	nr	1.000
09606452	bullone a strappo d.6,4x52 alluminio	nr	1.000

A richiesta rivettatrice cod. 85900508

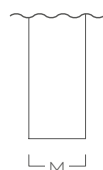

13.70 Nastri prontocar

Codice	Descrizione	U.m.	M	Conf.	Cr (kg)
13704504	nero	ml	45	100	2.200
13704504R	nero con riga blu	ml	45	100	2.200
13704503	grigio	ml	45	100	2.200



cinquanta

→ sistema prontocar

50



50.15 Ganci prontocar

Codice	Prodotto	U.m.	Conf.	H
50150001	uncino chiuso f.z.	nr	10	50

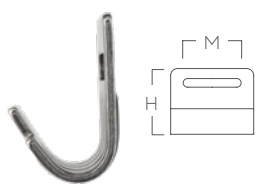

50.15 Ganci prontocar

Codice	Prodotto	U.m.	Conf.	M	S	A	H	
50150010	metal acciaio inox	A	nr	50	50	3	25	48
50150011	metal acciaio inox tipo K	B	nr	50	50	3	30	48
50150014	metal nichel	C	nr	50	50	3	30	55

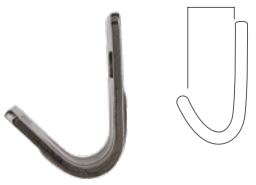

50.15 Prontocar

Codice	Prodotto	U.m.	Conf.
50151750	acciaio inox a scatto	nr	10



**50.15** Prontocar

Codice	Prodotto	U.m.	Conf.
50151752	acciaio inox a molla	nr	10

**50.15** Prontocar

Codice	Prodotto	U.m.	Conf.
50151753	acciaio inox a molla con freno	nr	10

**50.15** Cinghie prontocar

Codice	Prodotto	U.m.	Conf.
50150701	cm 70 gancio uncino chiuso f.z.	nr	10

A richiesta altre misure

**50.15** Cinghie prontocar

Codice	Prodotto	U.m.	Conf.
50150710	cm 70 gancio metal inox nastro nero	nr	10
50150711	cm 70 gancio metal f.z. nastro nero	nr	10
50150715HRB	cm 70 gancio metal inox nastro nero con riga blu	nr	10

A richiesta altre misure



Codice	Prodotto	U.m.	Conf.
50150715	cm 70 gancio metal inox nastro grigio	nr	10

A richiesta altre misure



cinquanta

→ sistema prontocar

50



50.08 Nastri riflettenti Orafol® · Oralite® · VC 104+

Codice	Prodotto	U.m.	Conf.
50085000	bianco adesivo sup. rigide	ml	50
50085002	giallo adesivo sup. rigide	ml	50
50085005	rosso adesivo sup. rigide	ml	50
50085030	bianco adesivo per PVC segmentato	ml	50
50085032	giallo adesivo per PVC segmentato	ml	50
50085035	rosso adesivo per PVC segmentato	ml	50



50.08 Nastri riflettenti 3M®

Codice	Prodotto	U.m.	Conf.
50086010	bianco adesivo per PVC segmentato - cod. 997	ml	50
50086022	giallo adesivo per PVC segmentato - cod. 997	ml	50
50086025	rosso adesivo per PVC segmentato - cod. 997	ml	50

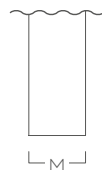

50.10 Cinghie saldabili pvc

Codice	Prodotto	U.m.	Conf.	M	Kg
50101706	grigia Kg 700 spessore 1,00 mm ± 0,3 mm	ml	100	25	700
50101800	bianca Kg 1300 spessore 1,00 mm ± 0,3 mm	ml	100	48	1.300
50101804	nera Kg 1300 spessore 1,00 mm ± 0,3 mm	ml	100	48	1.300
50101806	grigia Kg 1300 spessore 1,00 mm ± 0,3 mm	ml	100	48	1.300
50101808	avorio Kg 1300 spessore 1,00 mm ± 0,3 mm	ml	100	48	1.300
50101810	bianca Kg 2400 spessore 1,40 mm ± 0,3 mm	ml	100	48	2.400
50101811	grigia Kg 2400 spessore 1,40 mm ± 0,3 mm	ml	100	48	2.400
50101814	nera Kg 2400 spessore 1,40 mm ± 0,3 mm	ml	100	48	2.400





50.10 Cavo antitaglio saldabile

Codice	Prodotto	U.m.	Conf.	M
50101900	cinghia con cavo centrale acciaio*	ml	150	25

*Colore standard TRASPARENTE · A richiesta colori Nero e Grigio

Codice	Prodotto	U.m.	Conf.	M	Kg
50101906	cinghia grigia con cavi laterali acciaio	ml	150	25	700

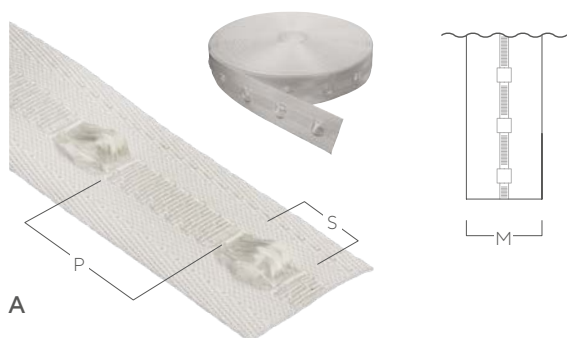

50.10 Cinghie saldabili pvc con asole

Codice	Prodotto	U.m.	Conf.	M	KG	P	S	
50105050	mm 50 *	B	ml	100	50	1.000	150	30
50107000	mm 70 in esaurimento	A	ml	100	70	1.400	50	25

* a richiesta mm 70



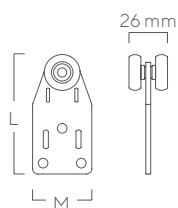

50.20 Carrucole MINI STAR contropiastre compatibili 25100200/25100210/25100211

Codice	Prodotto	U.m.	Conf.	L	M
50200024T	ruota nera nylon Ø 24 mm	nr	50	81	40

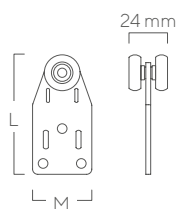

Codice	Prodotto	U.m.	Conf.	L	M
50200024GN	ruota nera NANO Ø 24 mm	nr	50	73,5	40

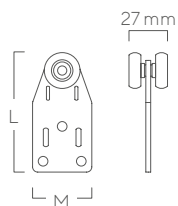

Codice	Prodotto	U.m.	Conf.	L	M
50200024G	ruota bianca nylon Ø 24 mm	nr	50	83	40

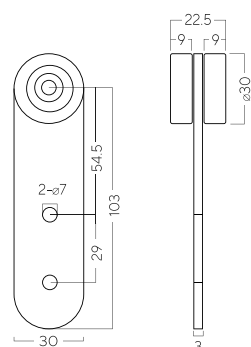

50.20 Carrucole BEST STAR contropiastre compatibili 50121759/R-760/R

Codice	Prodotto	U.m.	Conf.	M
50202530	ruota nylon Ø 30 mm	nr	50	30



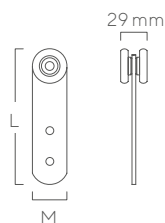

50.20 Carrucole 2 ruote

Codice	Prodotto	U.m.	Conf.	L	M
50202533	ruota nylon Ø 31 mm con protezione scorrevole	nr	50	120	30

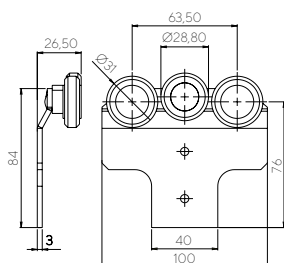

50.20 Carrucole 3 ruote per piantone

Codice	Prodotto	U.m.	Conf.
50203358	2 ruote arancio Ø 31 mm 1 ruota bianco Ø 28 mm	nr	10

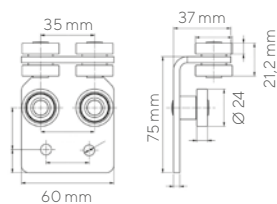

50.20 Carrucole ALU SCHMAL

Codice	Prodotto	U.m.	Conf.
50203524	ruota acciaio Ø 24 mm piastra piegata	nr	50

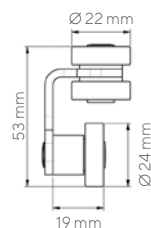
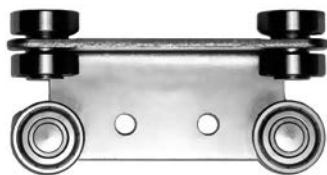

50.20 Carrucole ALU SCHMAL

Codice	Prodotto	U.m.	Conf.
50203527	ruota acciaio Ø 24 mm tropical piastra piegata per VERSUS	nr	50

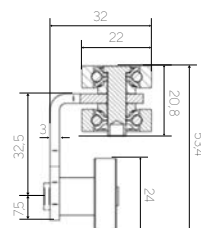

Codice	Prodotto	U.m.	Conf.
50203527G	ruota acciaio Ø 24 mm zincata piastra piegata per VERSUS	nr	50



cinquanta

→ sistema prontocar

interasse fori

50

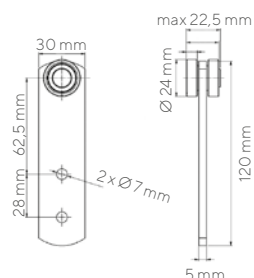

50.20 Carrucole ALU STAR
contropiastre compatibili 50121759/R-760/R

Codice	Prodotto	U.m.	Conf.
50203530	ruota acciaio Ø 24 mm	nr	50

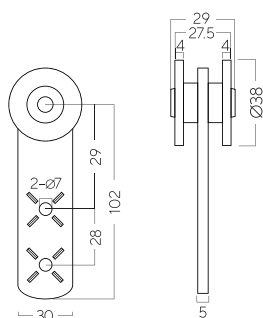

50.20 Carrucole SC5 FERRO GOLA
contropiastre compatibili 50121759/R-760/R

Codice	Prodotto	U.m.	Conf.	L	M
50205038	ruota Ø 38 mm	nr	50	128	30

Disponibile binario l. 7mt - Cod. 50205070

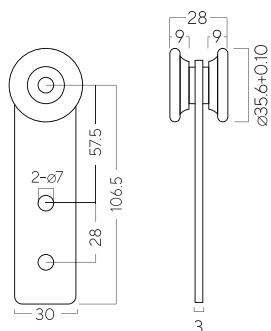

50.20 Carrucole FERRO GOLA CON SFERE
contropiastre compatibili 50121759/R-760/R

Codice	Prodotto	U.m.	Conf.	L	M
50205039	ruota con sfere Ø 36 mm	nr	50	125	30

Disponibile binario l. 7mt - Cod. 50205070



cinquanta

→ sistema prontocar

DEKRA
APPROVED

50

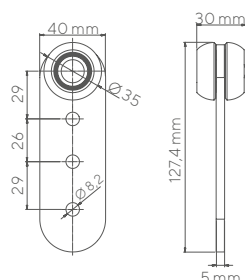

50.20 Carrucole
contropiastre compatibili 50121759/R-760/R

Codice	Prodotto	U.m.	Conf.
50208035	ruota nylon Ø 35 mm	nr	50

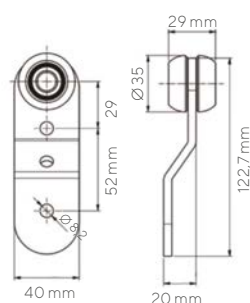

50.20 Carrucole

Codice	Prodotto	U.m.	Conf.
50208037	ruota nylon Ø 35 mm piastra piegata	nr	50

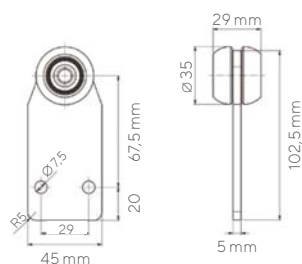

50.20 Carrucole
contropiastre compatibili 50121759/R-760/R

Codice	Prodotto	U.m.	Conf.
50208135	ruota nylon Ø 35 mm	nr	50

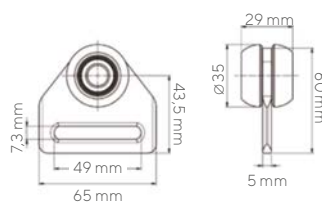

50.20 Carrucole

Codice	Prodotto	U.m.	Conf.
50208136	ruota nylon Ø 35 mm conasola	nr	50



cinquanta

→ sistema prontocar



50

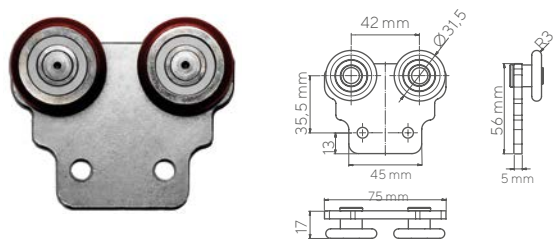

50.20 Carrucole
contropiastre compatibili 50121759/R-760/R

Codice	Prodotto	U.m.	Conf.
50208036	ruota nylon Ø 32 mm con 2 fori	nr	50



50.20 Carrucole

Codice	Prodotto	U.m.	Conf.
50208038	ruota nylon Ø 32 mm con asola	nr	50

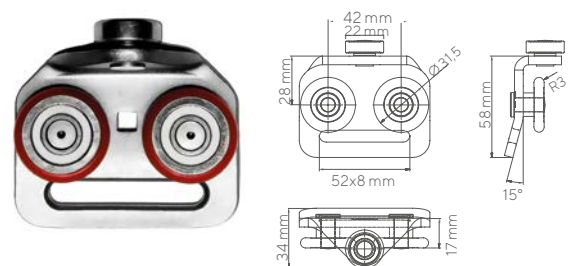

50.20 Carrucole

Codice	Prodotto	U.m.	Conf.
50208040	ruota nylon Ø 32 mm con asola piastra inclinata	nr	25



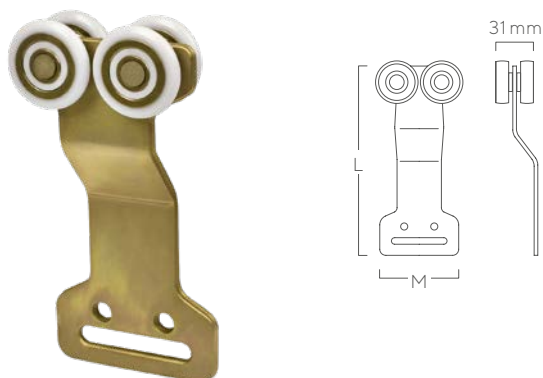

50.20 Carrucole contropiastre compatibili 50121770

Codice	Prodotto	U.m.	Conf.	L	M
50208039	ruota nylon Ø 35 mm staffa lunga	nr	25	155	65

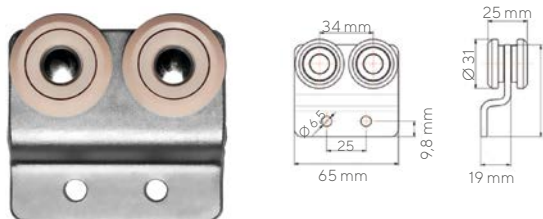

50.20 Carrucole contropiastre compatibili 50121770

Codice	Prodotto	U.m.	Conf.
50208235	ruota nylon Ø 31 mm piastra piegata 4 cuscinetti	nr	50

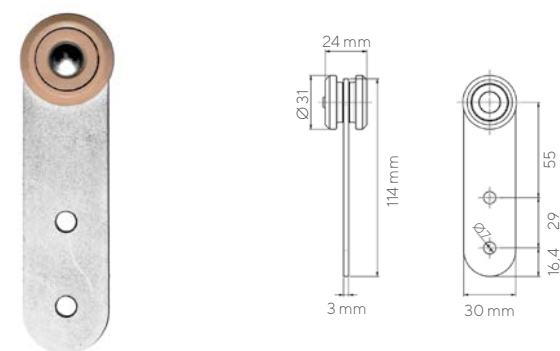

50.20 Carrucole contropiastre compatibili 50121759/R-760/R

Codice	Prodotto	U.m.	Conf.
50208236	ruota nylon Ø 31 mm	nr	50

cinquanta

→ sistema prontocar



50

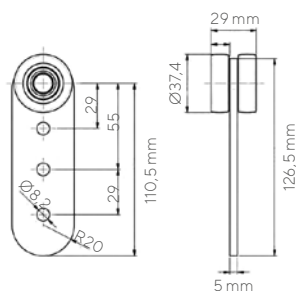

50.20 Carrucole BIGSTAR
contropiastre compatibili 50121759/R-760/R

Codice	Prodotto	U.m.	Conf.
50208237	ruota nylon Ø 37 mm	nr	50

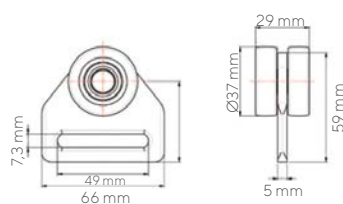

50.20 Carrucole BIGSTAR

Codice	Prodotto	U.m.	Conf.
50208238	ruota nylon Ø 37 mm con asola	nr	50



50.40 Barre tenditrici perni Ø 27mm



Codice	50401554
Prodotto	perno superiore Ø 27 mm
U.m./Conf.	nr. 2



Codice	50401273
Prodotto	barra tenditrice alluminio Ø 27 mm
U.m./Conf.	nr. 3 L 3,0



Codice	50401549
Prodotto	adattatore per perno inf. Ø 27mm
U.m./Conf.	nr. 2



Codice	50401553
Prodotto	perno inferiore Ø 27 mm
U.m./Conf.	nr. 2



Codice	50401553AI
Prodotto	perno inferiore acciaio inox Ø 27 mm
U.m./Conf.	nr. 2



Codice	50401556AL
Prodotto	perno inferiore alluminio con taglio Ø 27 mm
U.m./Conf.	nr. 2



Codice	50401600
Prodotto	riduttore per barra tenditrice Ø 27 mm
U.m./Conf.	nr. 2



Codice	50401553T
Prodotto	perno inferiore barra telescopica
U.m./Conf.	nr. 2



Codice	50401273T
Prodotto	barra tenditrice alluminio Ø 27 mm TELESCOPICA con adattatori
U.m./Conf.	nr. 2 L 2,75 estensibile fino a 3,15



cinquanta

→ sistema prontocar

50

50.40 Barre tenditrici perni Ø 35mm



Codice	50401556
Prodotto	perno superiore Ø 35 mm
U.m./Conf.	nr. 2



35 mm

Codice	50401353
Prodotto	barra tenditrice alluminio Ø 35 mm
U.m./Conf.	nr. 3 L 3,0



Codice	50401555
Prodotto	perno inferiore Ø 35 mm
U.m./Conf.	nr. 2



Codice	50401555AI
Prodotto	perno inferiore acciaio inox Ø 35 mm
U.m./Conf.	nr. 2

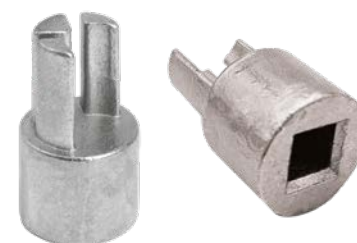

Codice	50401555Q
Prodotto	perno inferiore Ø 35 mm innesto quadro
U.m./Conf.	nr. 2



Codice	50401700
Prodotto	bussola alluminio con grano M6 d. 12x16 mm
U.m./Conf.	nr. 2



**50.45** Profili tensione telo alluminio

Codice	Prodotto	U.m.	Conf.	
504530CL	anodizzato ml 3,0 CL	nr	4	3,0
504565CL	anodizzato ml 6,6 CL	nr	4	6,6
504565CLG	grezzo ml 6,6 CL	nr	4	6,6

**50.45** Profili tensione telo alluminio

Codice	Prodotto	U.m.	Conf.	L
504530NL	anodizzato ml 3,0 NL	nr	4	3,0
504565NL	anodizzato ml 6,6 NL	nr	4	6,6

**50.45** Profili tensione telo alluminio

Codice	Prodotto	U.m.	Conf.	L
504565VT	anodizzato ml 6 vert.	nr	s.r.	6

Solo su richiesta

**50.45** Profili tensione telo alluminio

Codice	Prodotto	U.m.	Conf.	L
504565CC	anodizzato ml 6,6 CC	nr	4	6,6

**50.45** Pistone barra retrattile

Codice	Prodotto	U.m.	Conf.	L
50459000	F400N 145 mm	nr	1	145
50459001	F600N 156 mm	nr	1	156
50459002	F700N 205 mm	nr	1	205

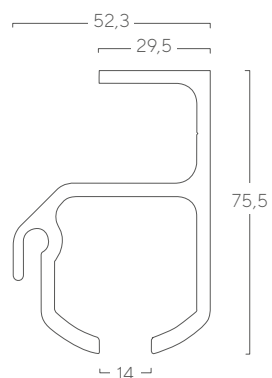

**50.20** Binari vari

Codice	Prodotto	U.m.	Conf.	L
50205071	binario alluminio ALU C	ml	14	7,0

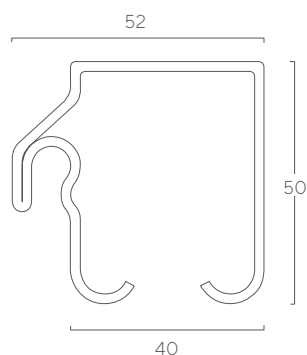
**50.20** Binari vari

Codice	Prodotto	U.m.	Conf.	L
50205070	binario FERRO GOLA	ml	14	7,0

**50.45** Canalina per guaina Versus

Codice	Prodotto	U.m.	Conf.	A	L
50459006	canalina per guaina Versus	ml	35	7	3,5

Guaina compatibile 50186516 - 50186517

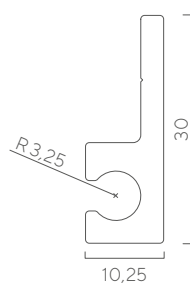
**50.45** Canalina per guaina Sesam

Codice	Prodotto	U.m.	Conf.	A	L
50459007	canalina per guaina Sesam	ml	35	3	7,0

Guaina compatibile 50186513



50.18 Guaine per binario

Codice	Prodotto	Col.	U.m.	Conf.	H (stesa)	S	D
50186511	Alu C - Ferro Gola	nero	ml	28	135	3,5	6
50186513	Alu Star - Schm. - Minil.	nero	ml	28	152	4	6
50186516	Versus - Nano - Lgl	nero	ml	14	148	4	5
50186517	Versus - Nano - Lgl	nero	ml	9	148	4	5
50186520	Versus - Alu Schm.	nero	ml	9	103	4	5,5
50186521	Versus - Alu Schm.	nero	ml	14	103	4	5,5
50186522	Trike	nero	ml	21	135	4	5,5
50186524	Trike	nero	ml	14	135	4	5,5
50186526	Trike	nero	ml	9	135	4	5,5
50186782	ATC	nero	ml	10	155	5	9,5
50186783	ATC	nero	ml	14	155	5	9,5
501862309	Versus - Alu Star	nero	ml	9	153	4,5	6
501862314	Versus - Alu Star	nero	ml	14	153	4,5	6
501862315	Versus - Alu Star	nero	ml	15	153	4,5	6
501862321	Versus - Alu Star	nero	ml	21	153	4,5	6
5018880609	Eds	nero	ml	9	124	4	6
5018880614	Eds	nero	ml	14	124	4	6
5018880616	Eds	grigio	ml	13,7	124	4	6
5018880616N	Eds	nero	ml	13,7	124	4	6



art.
50186511 Alu C - Ferro Gola

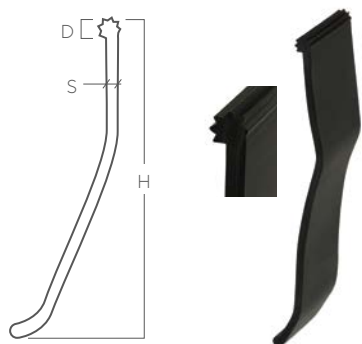

art.
50186513 Alu Star - Schm. - Minil.

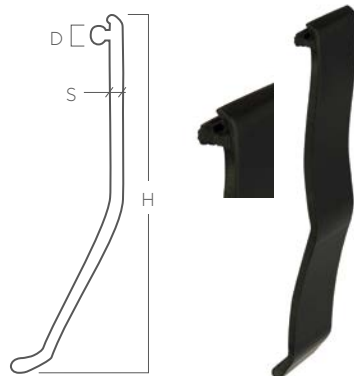

art.
50186516 Versus - Nano - Lgl
50186517

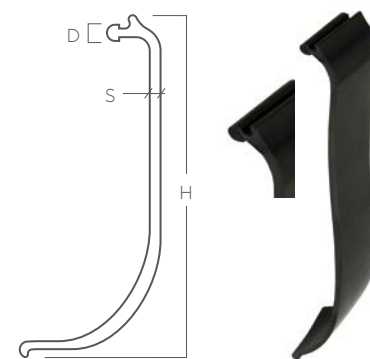

art.
50186520 Alu Schm. - Versus
50186521

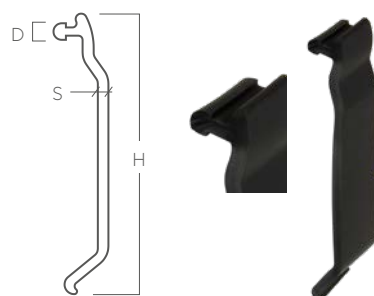

art.
50186522 Sch - Duo Trike
50186524
50186526

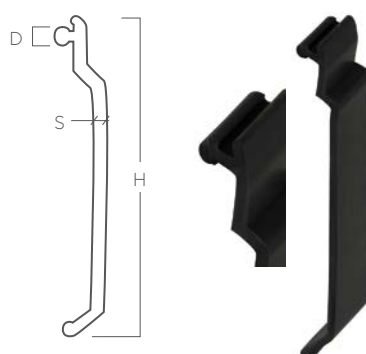

art.
50186782 ATC
50186783

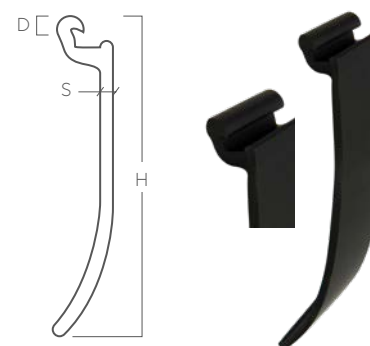

art.
501862309 Versus - Alu Star
501862314
501862315
501862321

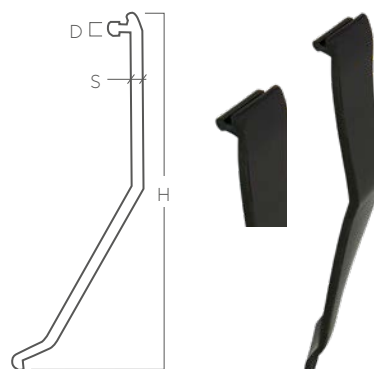

art.
5018880609 Eds
5018880614

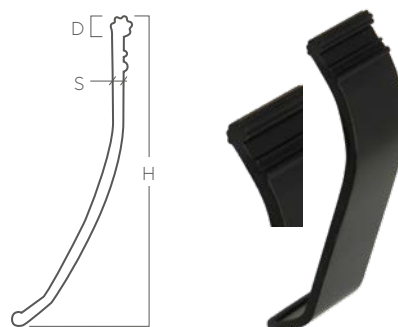

art.
5018880616 Eds
5018880616N nera

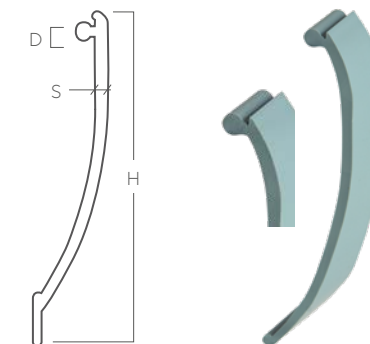

50.18 Cuscinetti

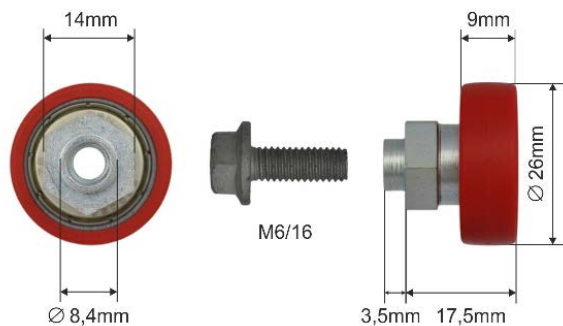

50181001

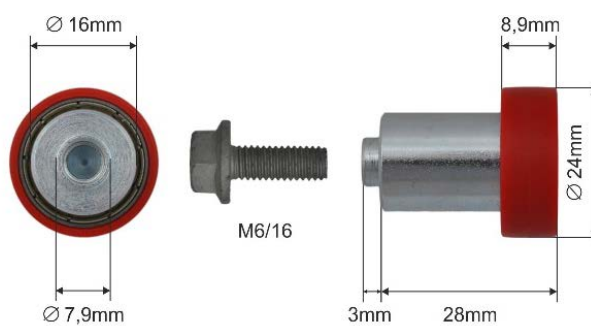

50181002

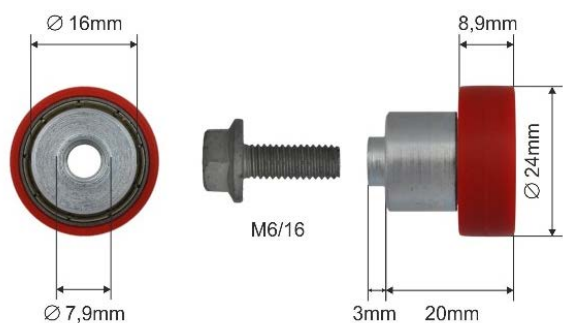

50181003

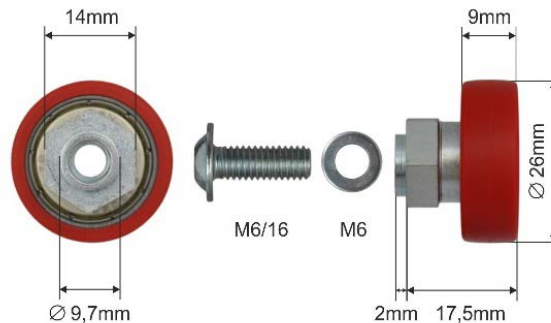

50181011



5018101T

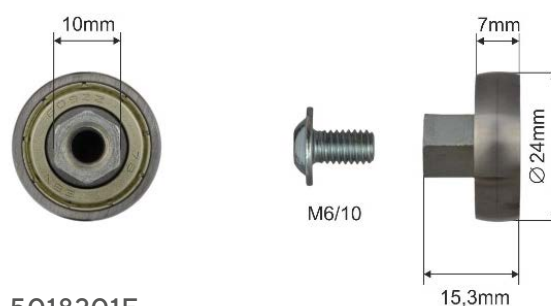

5018201E

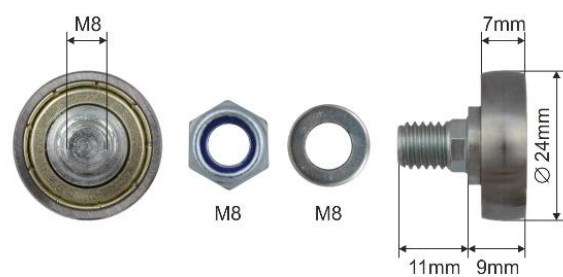

5018202E

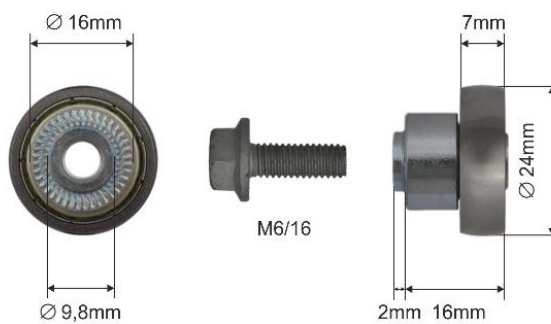

5018203M



50.18 Cuscinetti

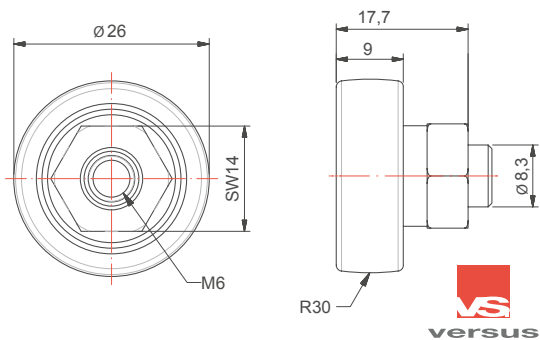

50183002

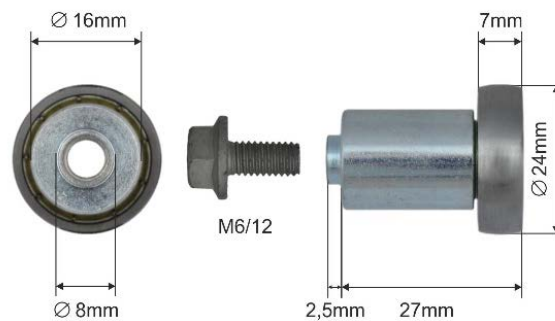

50183002

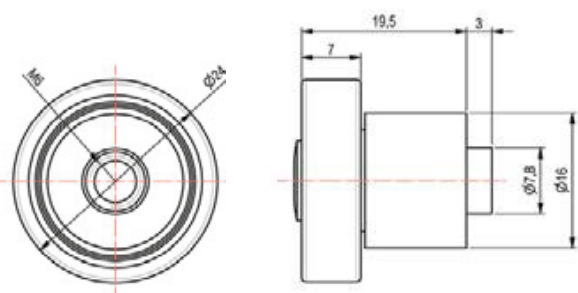

50183003

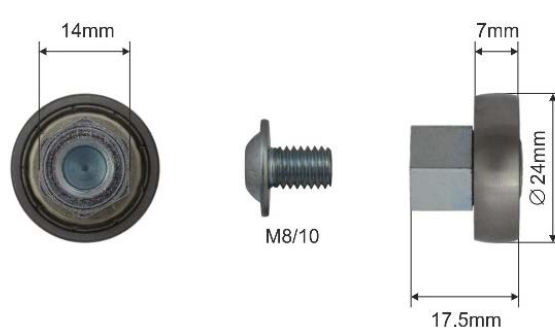

50183004

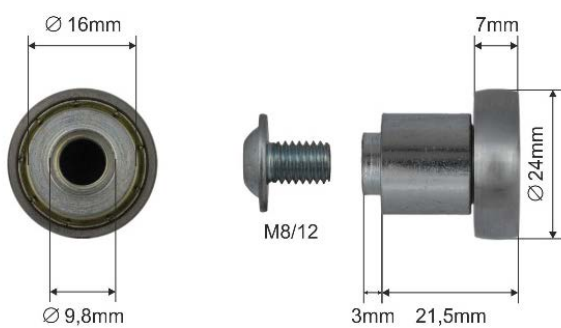

50183005

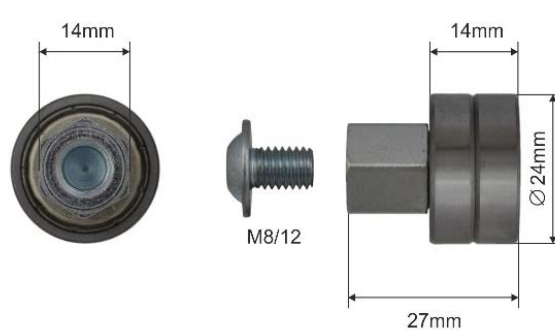

50183006

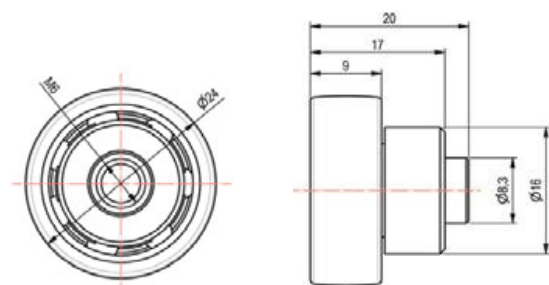

50183006



cinquanta

→ sistema prontocar

50

50.50 Piatti PVC tetto

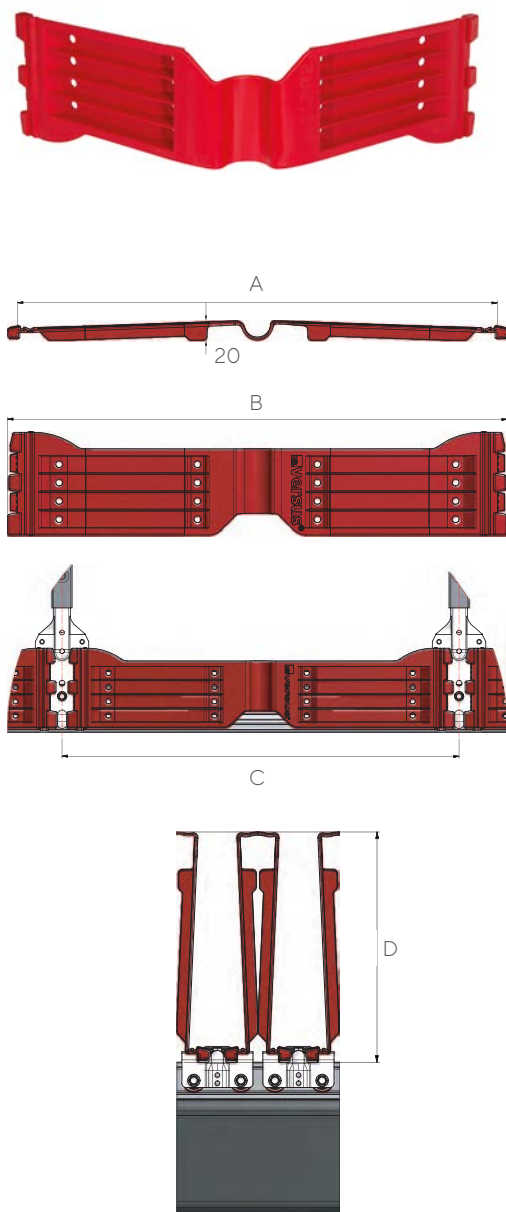

Codice	Prodotto		U.m.	Conf.	A	B	C	D
50500400	Versus mm 400	incastro rosso	nr	10	355	380	395	160
50500500	Versus mm 500	incastro rosso	nr	10	455	480	495	210
50500550	Versus mm 570*	incastro rosso	nr	10	530	555	570	247,5
50500600	Versus mm 600	incastro rosso	nr	10	555	580	595	260
50500650	Versus mm 650	incastro rosso	nr	10	610	635	650	287,5
50500700	Versus mm 700	incastro rosso	nr	10	655	680	695	310

*solo su richiesta



cinquanta

→ sistema prontocar

50

50.50 Piatti PVC tetto



Codice	Prodotto	U.m.	L	U.m.	Conf.
50500380	Eds mm 380	rivettare	verde	nr	10

50500570	Eds mm 570	rivettare	verde	nr	10
50500650RT	Eds mm 650	rivettare	verde	nr	10

50500650AT	Eds Ali mm 650	incastro	verde	nr	10
------------	----------------	----------	-------	----	----

50500600S	Sesam mm 600	incastro	nero	nr	10
50500600T	Tipo Sesam mm 600	incastro	nero	nr	10
50500700S	Sesam mm 700	incastro	nero	nr	10

5017061820	Roller per piatto EDS			nr	1
------------	-----------------------	--	--	----	---

5017061174	Roller per piatto Versus (versione per Kogel)			nr	1
------------	---	--	--	----	---

5017061175	Roller per piatto Versus (versione W/3 plastic bearing)			nr	1
------------	---	--	--	----	---



cinquanta

→ sistema prontocar

50

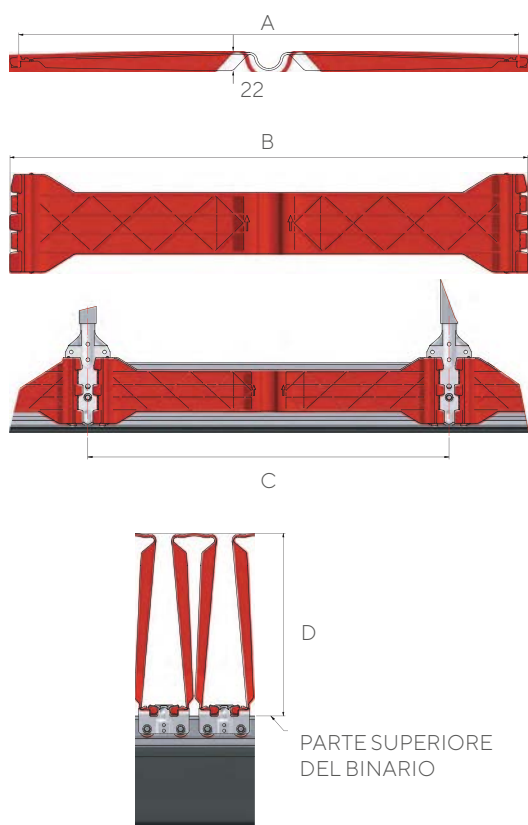

50.50 Piatti rinforzati solo su richiesta

Codice	Prodotto	U.m.	L	A	B	C	D
50500570VR	Piatto rinf. Versus mm 570	incastro rosso	530	555	570	247,5	
50500650VR	Piatto rinf. Versus mm 650	incastro rosso	610	635	650	287,5	
50500700VR	Piatto rinf. Versus mm 700	incastro rosso	655	680	695	310	



50.60 Nastri per tetto polietilene

Codice	Prodotto	U.m.	Conf.	L	M
50607500	mm 75 spessore 2	ml	50	50	75
50609000	mm 90 spessore 2	ml	50	50	90

A richiesta colore nero





50.19 Tenditore F30

Codice	Prodotto	U.m.	Conf.
50190300	zincato perno quadro Ø 27	nr	2
50190300K	chiave per tenditore F30	nr	1

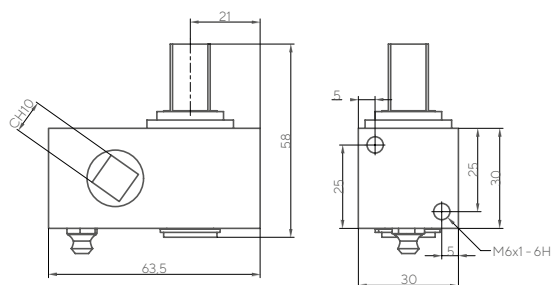

Sinistro



50.19 Tenditore F32

Codice	Prodotto	U.m.	Conf.
50190320L	sinistro zincato perno quadro Ø 27	nr	2
50190320R	destro zincato perno quadro Ø 27	nr	2

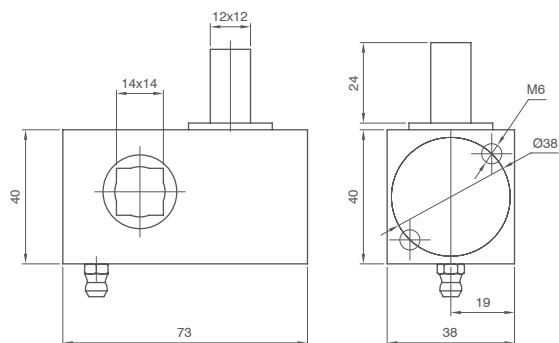

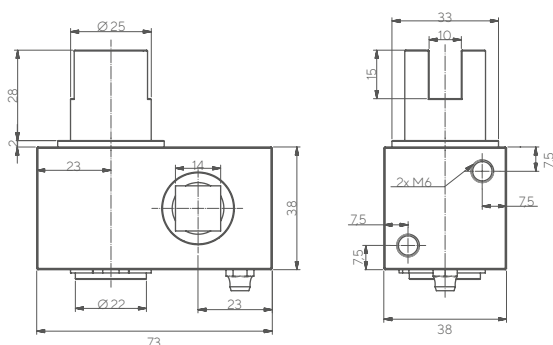

50.19 Tenditore BP34

Codice	Prodotto	U.m.	Conf.
50190340	zincato perno tondo Ø 35	nr	1



Sinistro

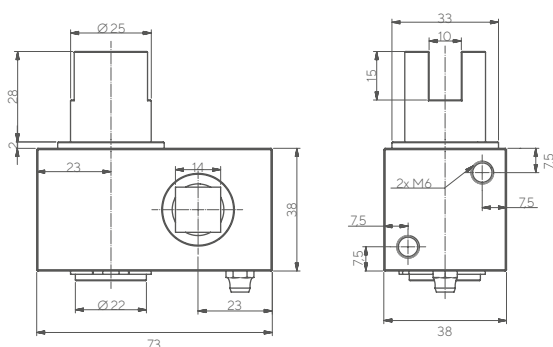

50.19 Tenditore BP36

Codice	Prodotto	U.m.	Conf.
50190360L	sinistro zincato perno tondo Ø 35	nr	2
50190360R	destra zincato perno tondo Ø 35	nr	2



cinquanta

→ sistema prontocar

50



50.19 Chiavi per tenditori

Codice	Prodotto	U.m.	Conf.
50190400	chiave per tenditori F32 - BP34 - BP36	nr	1



Sinistro



50.19 Tenditore BP41

Codice	Prodotto	U.m.	Conf.
50190401L	sinistro zincato perno quadro Ø 27	nr	2
50190401R	destra zincato perno quadro Ø 27	nr	2

La foto è riferita al destro



Sinistro



50.19 Tenditore BP42

Codice	Prodotto	U.m.	Conf.
50190501L	sinistro zincato perno tondo Ø 35	nr	2
50190501R	destra zincato perno tondo Ø 35	nr	2

La foto è riferita al destro



cinquanta

→ sistema prontocar

50

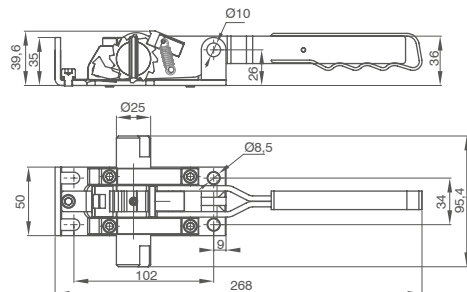

50.19 Tenditore F35

Codice	Prodotto	U.m.	Conf.
50190601	destro/sinistro zincato perno tondo Ø 35	nr	2

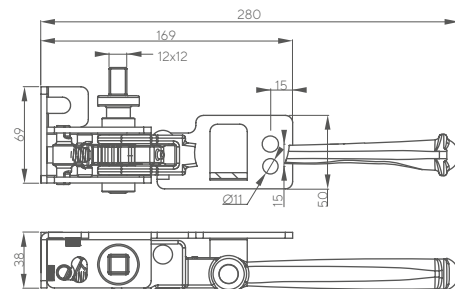

50.19 Tenditore F27

Codice	Prodotto	U.m.	Conf.
50190701L	sinistro Dacromet perno quadro Ø 27	nr	2
50190701R	destro Dacromet perno quadro Ø 27	nr	2



cinquanta

→ sistema prontocar

50

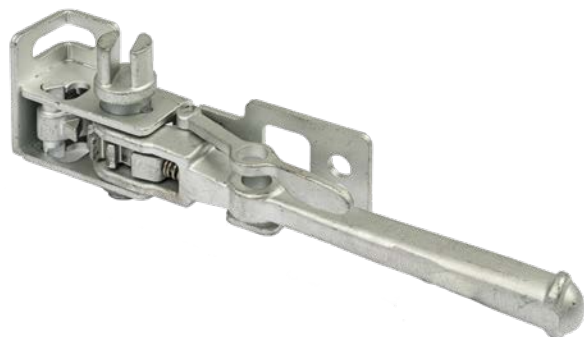

50.19 Tenditore F35

Codice	Prodotto	U.m.	Conf.
50190801L	sinistro dacromet perno tondo Ø 35	nr	2
50190801R	destra dacromet perno tondo Ø 35	nr	2

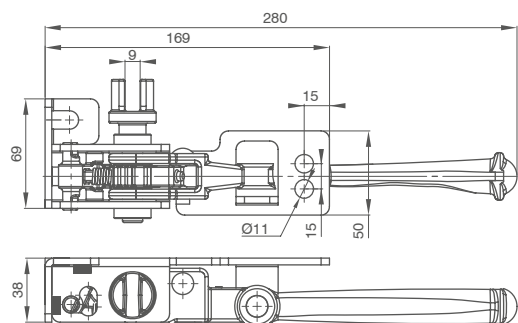

50.19 Chiusura zincata

Codice	Prodotto	U.m.	Conf.
50190901	completa di riscontro	nr	2

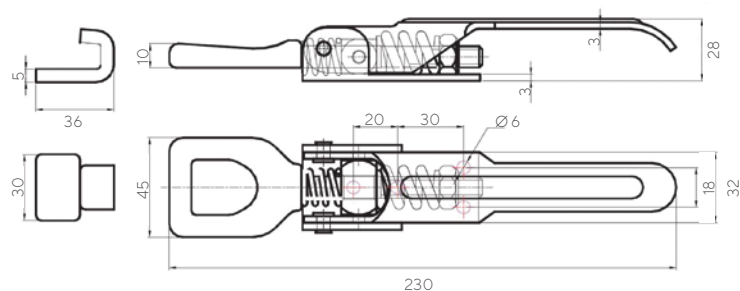

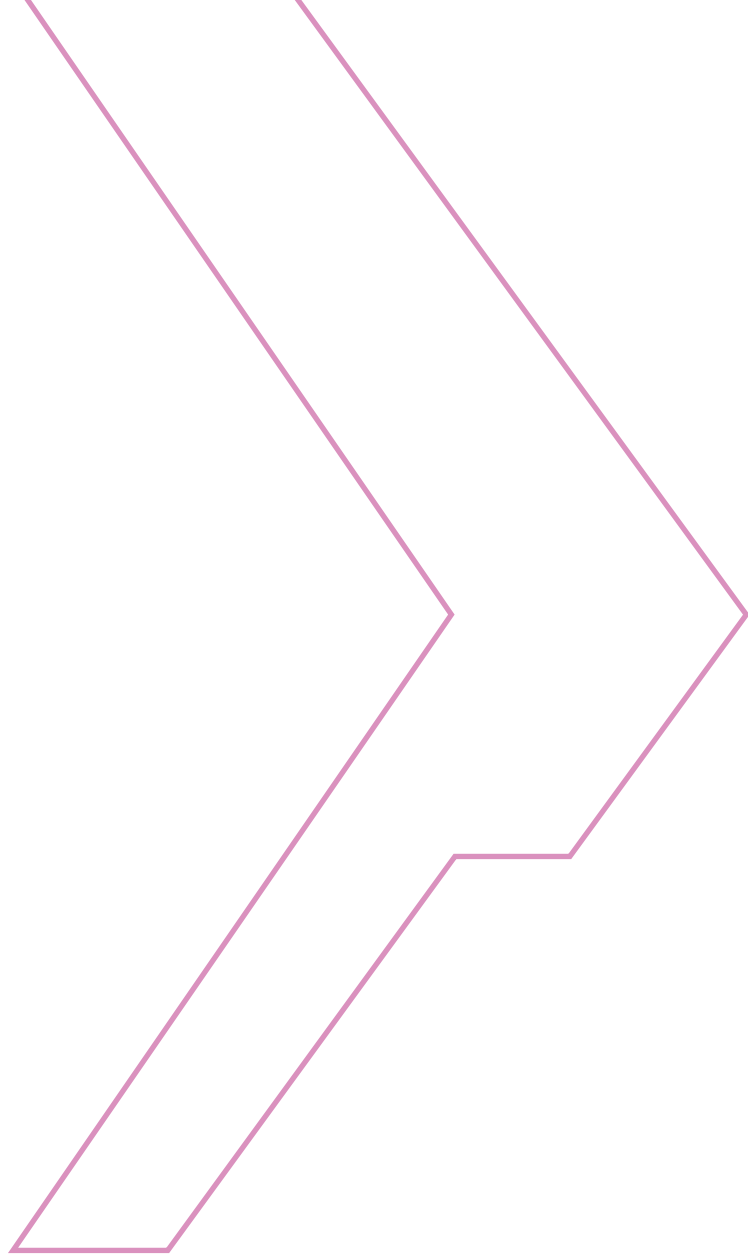

/
SETTANTA

Cristal, Profili
& Staffe

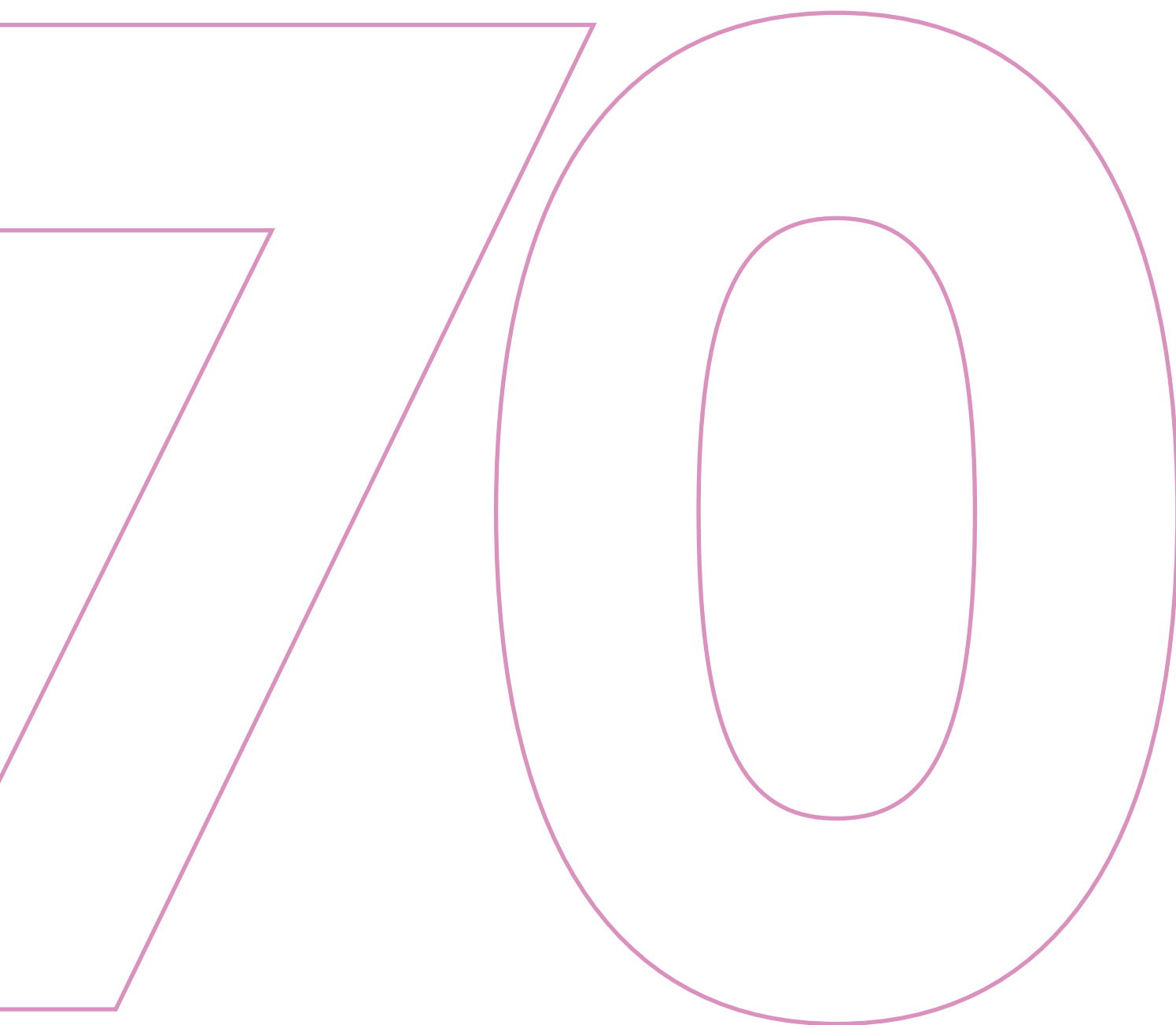

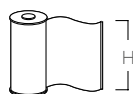
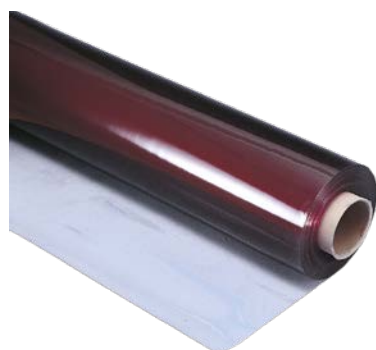

70.03 Cristal PLUS elevata trasparenza

Codice	Prodotto	U.m.	Conf.	gr/mq	S	Durezza	Resistenza°C
70035002	050 h.140 mm5/10	ml	50	620ca	0,50	2S	-65/-10
70036502	065 h.140 mm6,5/10	ml	30	800ca	0,65	3S	-65/-10
70038002	080 h.140 mm8/10	ml	30	1020ca	0,80	3S	-65/-10

codice	70035002	70036502	70038002	
utilizzi	tende ad avvolgimento verticale, chiusure laterali di pergole, strutture modulari finestrate	chiusure laterali di pergole, tende ad avvolgimento verticale, strutture modulari, coperture trasparenti	chiusure laterali, strutture modulari, coperture trasparenti, finestrate, inserti in porte industriali	
composizione	100% PVC	100% PVC	100% PVC	
peso	620 g/m ²	800 g/m ²	1020 g/m ²	ISO 2286-2
spessore	0,5 mm/500 μm	0,65 mm/650 μm	0,8 mm/800 μm	ISO 2286-3
durezza	2S	3S	3S	Scala Hand
altezza rotolo	140 cm	140 cm	140 cm	
lunghezza rotolo	50 m	30 m	30 m	
riciclabile	Sì	Sì	Sì	
resistenza alla trazione	MD-TD 220-200 Kg/cm ²	MD-TD 220-200 Kg/cm ²	MD-TD 220-200 Kg/cm ²	ASTM D882
allungamento a rottura	MD-TD 320-300%	MD-TD 350-350%	MD-TD 350-350%	ASTM D882
restringimento (70°C)	2,5%	3%	3%	ASTM D1204
resistenza allo strappo	MD-TD 60-60 Kg/cm	MD-TD 60-60 Kg/cm	MD-TD 60-60 Kg/cm	ASTM D1004
resistenza outdoor (quv test uva-340nm)	>1000 ore	>1000 ore	>1000 ore	ISO 4892-3
resistenza alle alte temperature (vicat test)	+65°C	+65°C	+65°C	
resistenza alle basse temperature (cold crack)	-10°C	-10°C	-10°C	

Le caratteristiche tecniche menzionate sono valori medi con una tolleranza di ± 5%. I valori indicati in questo documento sono dei risultati di test conformi agli usi in materia di studio, sono forniti perché la nostra clientela possa fare il miglior uso dei prodotti forniti. Essi sono altresì soggetti ad evoluzioni in funzione dei progressi tecnici e ci riserviamo la facoltà di modificarne le caratteristiche in qualsiasi momento. E' responsabilità dell'acquirente controllare la validità dei presenti dati. Gli acquirenti dei nostri prodotti hanno inoltre la responsabilità della loro applicazione, della loro trasformazione e confezione per ciò che riguarda gli eventuali diritti dei terzi, della loro messa in opera ed installazione in ottemperanza alle normative, alle regole dell'arte e alle regole di sicurezza vigenti nel Paese di destinazione.



settanta
→ cristal

70

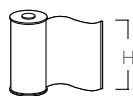
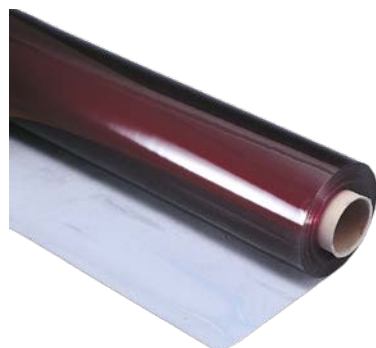

70.03 Cristal TOP senza Ftalati

Codice	Prodotto	U.m.	Conf.	gr/mq	S	Durezza	Resistenza°C
70033001	030 h.140 mm3/10 IGNIFUGO Cl.1	ml	100	370ca	0,30	2S	+65/-20
70035000	050 h.140 mm5/10	ml	50	620ca	0,50	2S	+65/-20
70035002I	050 h.140 mm5/10 IGNIFUGO Cl.1	ml	50	620ca	0,50	2S	+65/-20
70035003I	050 h.180 mm5/10 IGNIFUGO Cl.1	ml	50	610ca	0,50	2S	+65/-20
70036500	065 h.140 mm6,5/10	ml	50	800ca	0,65	3S	+65/-20
70036501	065 h.180 mm6,5/10	ml	50	800ca	0,65	3S	+65/-20
70036500I	065 h.180 mm6,5/10 IGNIFUGO Cl.1	ml	50	800ca	0,65	3S	+65/-20
70038000	80 h. 140 mm 8/10	ml	30	1020ca	0,80	3S	+65/-20
70038002I	80 h. 140 mm 8/10 IGNIFUGO Cl.1	ml	30	1020ca	0,80	3S	+65/-20



70.03 Cristal TOP senza Ftalati

codice	70033001	70035000	700350021 / 700350031	
utilizzi	Chiusure laterali, finestre, tende da campeggio e verande	Tende ad avvolgimento verticale, chiusure laterali di pergole, strutture modulari e finestre.	Tende ad avvolgimento verticale, chiusure laterali di pergole, strutture modulari e finestre.	
composizione	Film in PVC Plastificato trasparente stabilizzato UV	Film in PVC Plastificato trasparente stabilizzato UV	Film in PVC Plastificato trasparente stabilizzato UV	
peso	370 g/m ²	620 g/m ²	620 g/m ²	ISO 2286-2
spessore	0,3 mm/300 µm	0,5 mm/500 µm	0,5 mm/500 µm	ISO 2286-3
durezza	2S	2S	2S	Scala Hand
altezza rotolo	140 cm	140 cm	140 cm / 180 cm	
lunghezza rotolo	100 m	50 m	50 m	
senza ftalati	Sì	Sì	sì	
riciclabile	Sì	Sì	sì	
resistenza alla trazione	MD-TD 220-200 Kg/cm ²	MD-TD 220-200 Kg/cm ²	MD-TD 220-200 Kg/cm ²	ASTM D882
allungamento a rottura	MD-TD 350-350%	MD-TD 350-350%	MD-TD 350-350%	ASTM D882
restringimento (70°C)	2,5%	2,5%	2,5%	ASTM D1204
resistenza allo strappo	MD-TD 60-60 Kg/cm	MD-TD 60-60 Kg/cm	MD-TD 60-60 Kg/cm	ASTM D1004
classificazione di reazione al fuoco	Classe 1 (IT)	NO	Classe 1 (IT)	UNI 9177
	M2 (FR)		M2 (FR)	NF P92-507
resistenza outdoor (quv test uva-340nm)	>1000 ore	>1000 ore	>1000 ore	ISO 4892-3
resistenza alle alte temperature (vicat test)	+65°C	+65°C	+65°C	
resistenza alle basse temperature (cold crack)	-20°C	-20°C	-20°C	

Le caratteristiche tecniche menzionate sono valori medi con una tolleranza di $\pm 5\%$. I valori indicati in questo documento sono dei risultati di test conformi agli usi in materia di studio, sono forniti perché la nostra clientela possa fare il miglior uso dei prodotti forniti. Essi sono altresì soggetti ad evoluzioni in funzione dei progressi tecnici e ci riserviamo la facoltà di modificarne le caratteristiche in qualsiasi momento. E' responsabilità dell'acquirente controllare la validità dei presenti dati. Gli acquirenti dei nostri prodotti hanno inoltre la responsabilità della loro applicazione, della loro trasformazione e confezione per ciò che riguarda gli eventuali diritti dei terzi, della loro messa in opera ed installazione in ottemperanza alle normative, alle regole dell'arte e alle regole di sicurezza vigenti nel Paese di destinazione.



70.03 Cristal TOP senza Ftalati

70036500 / 70036501	700365001	70038000	700380021	
Tende ad avvolgimento verticale, chiusure laterali di pergole, strutture modulari e finestrate.	Tende ad avvolgimento verticale, chiusure laterali di pergole, strutture modulari e finestrate.	Chiusure laterali, strutture modulari, coperture trasparenti, finestrate, inserti in porte industriali	Chiusure laterali, strutture modulari, coperture trasparenti, finestrate, inserti in porte industriali	
Film in PVC Plastificato trasparente stabilizzato UV	Film in PVC Plastificato trasparente stabilizzato UV	Film in PVC Plastificato trasparente stabilizzato UV	Film in PVC Plastificato trasparente stabilizzato UV	
800 g/m ²	800 g/m ²	1020 g/m ²	1020 g/m ²	ISO 2286-2
0,65 mm/650 µm	0,65 mm/650 µm	0,80 mm/800 µm	0,80 mm/800 µm	ISO 2286-3
3S	3S	3S	3S	Scala Hand
140 cm / 180 cm	180 cm	140 cm	140 cm	
50 m	50 m	30 m	30 m	
sì	sì	sì	sì	
sì	sì	sì	sì	
MD-TD 220-200 Kg/cm ²	MD-TD 220-200 Kg/cm ²	MD-TD 220-200 Kg/cm ²	MD-TD 220-200 Kg/cm ²	ASTM D882
MD-TD 350-350%	MD-TD 350-350%	MD-TD 350-350%	MD-TD 350-350%	ASTM D882
3%	3%	3%	3%	ASTM D1204
MD-TD 60-60 Kg/cm	MD-TD 60-60 Kg/cm	MD-TD 60-60 Kg/cm	MD-TD 60-60 Kg/cm	ASTM D1004
NO	Classe 1 (IT) M2 (FR)	NO	Classe 1 (IT) M2 (FR)	UNI 9177 NF P92-507
>1000 ore	>1000 ore	>1000 ore	>1000 ore	ISO 4892-3
+65°C	+65°C	+65°C	+65°C	
-20°C	-20°C	-20°C	-20°C	

Le caratteristiche tecniche menzionate sono valori medi con una tolleranza di ± 5%. I valori indicati in questo documento sono dei risultati di test conformi agli usi in materia di studio, sono forniti perché la nostra clientela possa fare il miglior uso dei prodotti forniti. Essi sono altresì soggetti ad evoluzioni in funzione dei progressi tecnici e ci riserviamo la facoltà di modificarne le caratteristiche in qualsiasi momento. E' responsabilità dell'acquirente controllare la validità dei presenti dati. Gli acquirenti dei nostri prodotti hanno inoltre la responsabilità della loro applicazione, della loro trasformazione e confezione per ciò che riguarda gli eventuali diritti dei terzi, della loro messa in opera ed installazione in ottemperanza alle normative, alle regole dell'arte e alle regole di sicurezza vigenti nel Paese di destinazione.

settanta
→ cristal

70

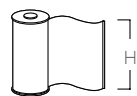
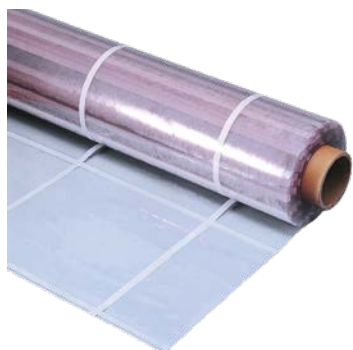

70.15 Cristal TOP Finestrato

Codice	Prodotto	U.m.	Conf.	gr/mq	S	Durezza
7015F130	h. 132 mm 3/10 ignifugo	ml	100	370 ca	0,30mm	2S
7015F151I	h. 132 mm 5,0/10 ignifugo	ml	50	610 ca	0,50	2S

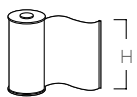

70.15 Cristalplus gofrato

Codice	Prodotto	U.m.	Conf.	gr/mq	S	Durezza
7015C030	h.140 mm 3/10 disegno G42	ml	50	ND	0,30	



settanta
→ cristal

70

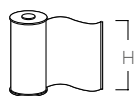
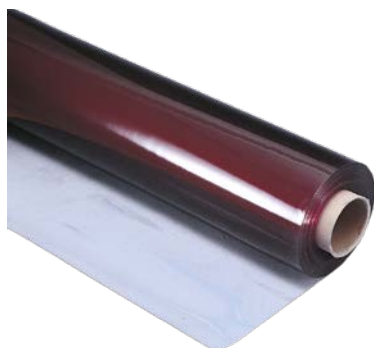

70.04 Cristal PRIME

NEW

Codice	Prodotto	U.m.	Conf.	gr/mq
70040250	025 h.140 mm 2,5/10	ml	100	310ca
70040300	030 h.140 mm 3/10	ml	80	372ca
70040400	040 h.140 mm 4/10	ml	60	496ca
70040500	050 h.140 mm 5/10	ml	50	610ca
70040501	050 h.183 mm 5/10	ml	30	610ca
70040650	065 h.140 mm 6,5/10	ml	30	806ca
70040750	075 h.140 mm 7,5/10	ml	30	915ca
70041000	100 h.140 mm 10/10	ml	30	1220ca
70040300I	030 h.140 mm 3/10 flame retardant	ml	80	372ca
70040500I	050 h.140 mm 5/10 flame retardant	ml	50	610ca
70040750I	075 h.140 mm 7,5/10 flame retardant	ml	30	915ca



70.04 Cristal PRIME

codice	70040250	70040300	70040400	
utilizzi	tende ad avvolgimento verticale, chiusure laterali di pergole, strutture modulari finestrate	tende ad avvolgimento verticale, chiusure laterali di pergole, strutture modulari finestrate	tende ad avvolgimento verticale, chiusure laterali di pergole, strutture modulari finestrate	
composizione	100% PVC	100% PVC	100% PVC	
peso	310 g/m ²	372 g/m ²	496 g/m ²	
spessore	0,25 mm/250 μm +/-5%	0,3 mm/300 μm +/-5%	0,4 mm/400 μm +/-5%	EN2286-3 (10mm*50kpa)
durezza	42	46	46	PHR
altezza rotolo	140 cm	140 cm	140 cm	
lunghezza rotolo	100 m	80 m	60 m	
riciclabile	Sì	Sì	Sì	
resistenza alla trazione	MD-TD 28,0-27,1 n/mm ²	MD-TD 27,0-23,7 n/mm ²	MD-TD 27,4-23,6 n/mm ²	ASTM D882-02
allungamento a rottura	MD-TD 289,8-279,9%	MD-TD 278,1-284,9%	MD-TD 275,8-288,4%	ASTM D882-02
resistenza outdoor (xenotest)	2000 ore	2000 ore	2000 ore	ASTM D1499
resistenza alle basse temperature (cold crack)	-10 °C	-25 °C	-20 °C	EN 1876-2
	-15 °C	-20 °C	-20 °C	ASTM D179-02
	-40 °C	-40 °C	-30 °C	EN 495-5

Le caratteristiche tecniche menzionate sono valori medi con una tolleranza di $\pm 5\%$. I valori indicati in questo documento sono dei risultati di test conformi agli usi in materia di studio, sono forniti perché la nostra clientela possa fare il miglior uso dei prodotti forniti. Essi sono altresì soggetti ad evoluzioni in funzione dei progressi tecnici e ci riserviamo la facoltà di modificarne le caratteristiche in qualsiasi momento. E' responsabilità dell'acquirente controllare la validità dei presenti dati. Gli acquirenti dei nostri prodotti hanno inoltre la responsabilità della loro applicazione, della loro trasformazione e confezione per ciò che riguarda gli eventuali diritti dei terzi, della loro messa in opera ed installazione in ottemperanza alle normative, alle regole dell'arte e alle regole di sicurezza vigenti nel Paese di destinazione.



70.04 Cristal PRIME

70040500	70040650	70040750	70041000	
tende ad avvolgimento verticale, chiusure laterali di pergole, strutture modulari finestrate	chiusure laterali di pergole, tende ad avvolgimento verticale, strutture modulari, coperture trasparenti	chiusure laterali, strutture modulari, coperture trasparenti, finestrate, inserti in porte industriali	chiusure laterali, strutture modulari, coperture trasparenti, finestrate, inserti in porte industriali	
100% PVC	100% PVC	100% PVC	100% PVC	
610 g/m ²	806 g/m ²	915 g/m ²	1220 g/m ²	
0,5 mm/500 μm +/-5%	0,65 mm/650 μm +/-5%	0,75 mm/750 μm +/-5%	1 mm/1000 μm +/-5%	EN2286-3 (10mm*50kpa)
40 46	46	46	46	PHR
140 cm	140 cm	140 cm	140 cm	
50 m	30 m	30 m	30 m	
Sì	Sì	Sì	Sì	
MD-TD 27,6-24,2 n/mm ²	MD-TD 26,7-22 n/mm ²	MD-TD 25,4-22,1 n/mm ²	MD-TD 25,0-19,5 n/mm ²	ASTM D882-02
MD-TD 296,5-309,2%	MD-TD 303,7-312,1%	MD-TD 304,5-308%	MD-TD 324,1-310,1%	ASTM D882-02
2000 ore	2000 ore	2000 ore	2000 ore	ASTM D1499
-15°C -20 °C	-20 °C	-30 °C	-25 °C	EN 1876-2
-15 °C -20 °C	-20 °C	-20 °C	-20 °C	ASTM D179-02
-30 °C -30 °C	-30 °C	-30 °C	-35 °C	EN 495-5

Le caratteristiche tecniche menzionate sono valori medi con una tolleranza di $\pm 5\%$. I valori indicati in questo documento sono dei risultati di test conformi agli usi in materia di studio, sono forniti perché la nostra clientela possa fare il miglior uso dei prodotti forniti. Essi sono altresì soggetti ad evoluzioni in funzione dei progressi tecnici e ci riserviamo la facoltà di modificarne le caratteristiche in qualsiasi momento. E' responsabilità dell'acquirente controllare la validità dei presenti dati. Gli acquirenti dei nostri prodotti hanno inoltre la responsabilità della loro applicazione, della loro trasformazione e confezione per ciò che riguarda gli eventuali diritti dei terzi, della loro messa in opera ed installazione in ottemperanza alle normative, alle regole dell'arte e alle regole di sicurezza vigenti nel Paese di destinazione.



70.30 Cristal in lastra

Codice	Prodotto	U.m.	Conf.
70300075	mm 0,75 h. 1,37 x 2,8 L	nr	5 fogli
70300100	mm 1,00 h. 1,37 x 2,8 L	nr	5 fogli

a richiesta prodotti specifici per la pulizia



70.07 Cristal Art Colorato Trasparente solo su richiesta

Codice	Prodotto	U.m.	Conf.	S
7007050C	h.140 mm 5/10 azzurro	ml	40	0,5
7007051C	h.140 mm 5/10 giallo	ml	40	0,5
7007052C	h.140 mm 5/10 rosso	ml	40	0,5
7007053C	h.140 mm 5/10 brunito	ml	40	0,5

Le specifiche tecniche indicate sono valori medi con una tolleranza del $\pm 5\%$. Informazioni non vincolanti.

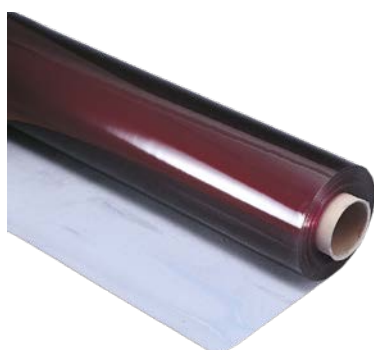

70.08 Cristal PRINT con Lyner

Codice	Prodotto	U.m.	Conf.	S	Durezza
70085003	Cristal ART 50 h. 140 mm 5/10 1 con lyner in poliestere	ml	30	0,5	2S



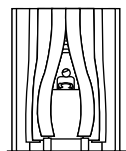
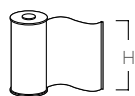

70.50 Cristal port in strisce per porte lamellari

Codice	Prodotto	U.m.	Conf.	H	gr/MI	kg/rt
70502010	mm 2 h. 100 trasparente	ml	50	100	240	12
70502020	mm 2 h. 200 trasparente	ml	50	200	480	24
70502020C	mm 2 h. 200 arancio trasparente	ml	50	200	480	24
70502020G	mm 2 h. 200 grigio coprente	ml	50	200	480	24
70502020O	mm 2 h. 200 satinato opaco	ml	50	200	480	24
70502020P	mm 2 h. 200 polare	ml	50	200	480	24
70502020R	mm 2 h. 200 rosso trasparente	ml	50	200	480	24
70502020Y	mm 2 h. 200 giallo trasparente	ml	50	200	480	24
70502030	mm 2 h. 300 trasparente	ml	50	300	740	37
70502030R	mm 2 h. 300 rosso trasparente	ml	50	300	740	37
70503020	mm 3 h. 200 trasparente	ml	50	200	740	37
70503030	mm 3 h. 300 trasparente	ml	50	300	1040	52
70503030N	mm 3 h. 300 nero coprente	ml	50	300	1040	52
70503030R	mm 3 h. 300 rosso trasparente	ml	50	300	1040	52
70503030O	mm 3 h. 300 satinato opaco	ml	50	300	1040	52
70503030P	mm 3 h. 300 popolare	ml	50	300	1040	52
70504040	mm 4 h. 400 trasparente	ml	50	400	1960	98

materiale AUTOESTINGUENTE, NON IGNIFUGO, AD USO ALIMENTARE

resistenza temperatura +50° / -15°

a richiesta altri spessori e altezze / a richiesta versione POLARE - 25°

a richiesta versione antistatica / a richiesta versione opaca / colore arancio trasparente



settanta
→ cristal

70

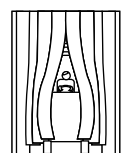
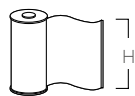

70.52 Cristal port in manti

Codice	Prodotto	U.m.	Conf.	H	gr/MI	kg/rt
70522100	mm 2 h. 1000 ml 20	ml	20	1000	2450	49
70522120	mm 2 h. 1200 ml 20	ml	20	1200	2950	59
70522150	mm 2 h. 1500 ml 20	ml	20	1500	3650	73
70523100	mm 3 h. 1000 ml 20	ml	20	1000	3650	73
70523120	mm 3 h. 1200 ml 20	ml	20	1200	4400	88
70523150	mm 3 h. 1500 ml 20	ml	20	1500	5500	110
70525100	mm 5 h. 1000 ml 20	ml	20	1000	6100	122
70525120	mm 5 h. 1200 ml 20	ml	20	1200	7300	146
70525150	mm 5 h. 1500 ml 20	ml	20	1500	9150	183

materiale AUTOESTINGUENTE, NON IGNIFUGO, AD USO ALIMENTARE
resistenza temperatura +50° / -15°
a richiesta altri spessori e altezze / a richiesta versione POLARE - 25°
a richiesta versione antistatica





70.56 Profili e staffe f.z.

Codice	Prodotto	U.m.	Conf.	L
70560100	profilo ml 1	nr	1	1
70560200	profilo ml 2	nr	1	2
70560300	profilo ml 3	nr	1	3

Codice	Prodotto	U.m.	Conf.	M
70561200	staffa mm 200	nr	10	200
70561300	staffa mm 300	nr	10	300
70561400	staffa mm 400	nr	10	400



70.56 Profili e staffe acciaio inox 430

Codice	Prodotto	U.m.	Conf.	L
70560200AI	profilo ml 1,96	nr	1	1,96

A richiesta altre misure

Codice	Prodotto	U.m.	Conf.	M
70561200AI	staffa mm 200	nr	10	200
70561300AI	staffa mm 300	nr	10	300



Esempi di montaggio

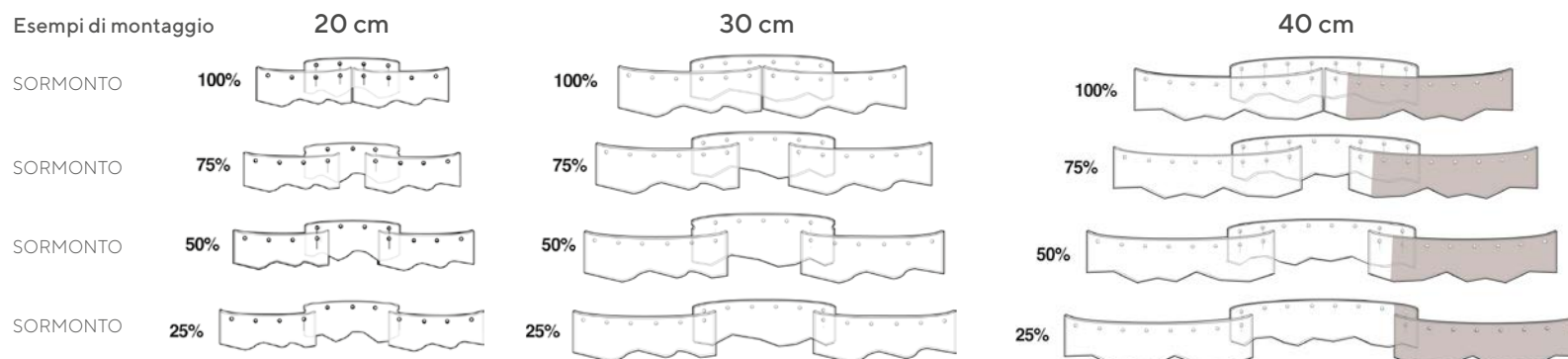

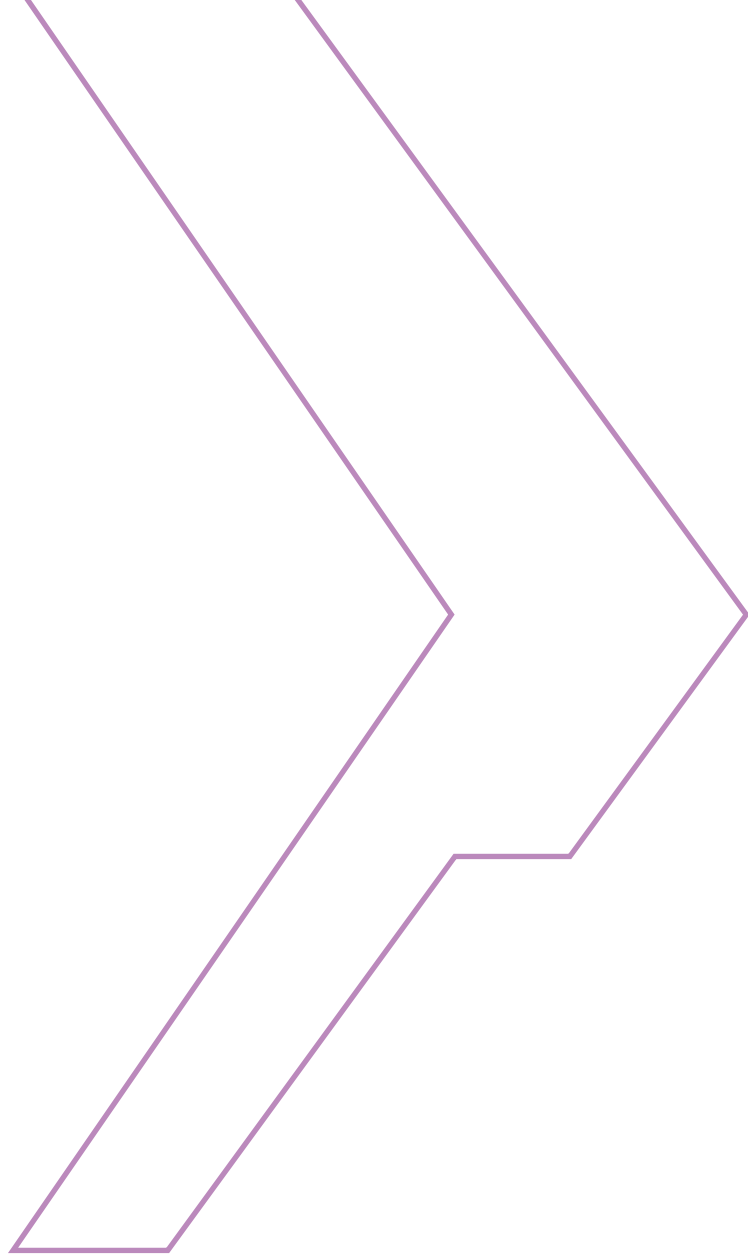

/
SETTANTACINQUE

Reti





75.01 Reti indemagliabili

Codice	Prodotto	U.m.	Conf.	L	H	gr/mq
75014001	blu h. 400 ombreggiante 70%	mq	400	100	4	230
75014006	verde h. 400 ombreggiante 70%	mq	400	100	4	150
75017001	bordata e occhiellata blu ombreggiante 70%	mq	a misura			230
75017006	bordata e occhiellata verde ombreggiante 50%	mq	a misura			150

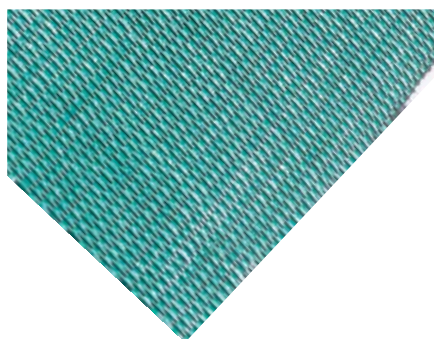

75.10 Reti ombreggianti frangivento

Codice	Prodotto	U.m.	Conf.	L	H	gr/mq
75107026	75 % verde h. 200	mq	200	100	2	135
75107046	75 % verde h. 400	mq	400	100	4	135
75109026	90 % verde h. 200	mq	200	100	2	155
75109046	90 % verde h. 400	mq	400	100	4	155

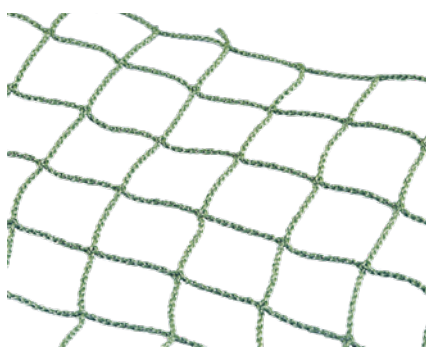

75.20 Reti a rombi

Codice	Prodotto	U.m.	Conf.	gr/mq
75202506	mm 25x25 verde bordata	mq	a misura	210
75204006	mm 45x45 verde bordata	mq	a misura	120
75204006B	mm 45x45 bianca bordata	mq	a misura	120

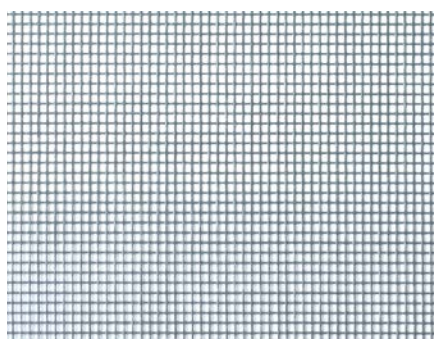

75.20 Zanzariera fibra vetro ricoperta PVC

Codice	Prodotto	U.m.	Conf.	L	H
75200125	rete zanzariera h. 120 grigia	mq	36	30	120
75200125N	rete zanzariera h. 120 nera*	mq	36	30	120
75200165	rete zanzariera h. 160 grigia	mq	48	30	160

*solo su richiesta



/
SETTANTANTOTTO

Cerniere, chiusura a strappo,
filo per cucire e altri prodotti



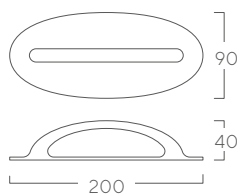
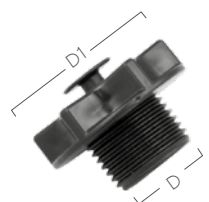

78.01 Tappi per piscina Saldabili ad alta frequenza

Codice	Prodotto	U.m.	Conf.
78010400	a vite - tappo doppia chiusura - tenuta aria-acqua	nr	100

A richiesta altri colori

Codice	Prodotto	U.m.	Conf.	D	D1
78010300	a vite - tappo nero - tenuta acqua	nr	100	20	40
78010301	a vite - tappo bianco - tenuta acqua	nr	100	20	40
78010302	a vite - tappo azzurro - tenuta acqua	nr	100	20	40

A richiesta altri colori

Codice	Prodotto	U.m.	Conf.	D	D1
78010200	a vite - codulo nero - tenuta acqua	nr	100	68	20
78010201	a vite - codulo bianco - tenuta acqua	nr	100	68	20
78010202	a vite - codulo azzurro - tenuta acqua	nr	100	68	20

A richiesta altri colori

Codice	Prodotto	U.m.	Conf.
78010203	a vite - laccetto di sicurezza nero	nr	100
78010204	a vite - laccetto di sicurezza bianco	nr	100
78010206	a vite - laccetto di sicurezza azzurro	nr	100

A richiesta altri colori

Codice	Prodotto	U.m.	Conf.	D	D1
78010100	a pressione nero	nr	100	61	27
78010102	a pressione azzurro	nr	100	61	27

A richiesta altri colori

Codice	Prodotto	U.m.	Conf.
05253000S	maniglia PVC nera saldabile	nr	10





78.02 Valvola di gonfiaggio

Codice	Prodotto	U.m.	Conf.
78020050	Valvola gonfiaggio	nr	10
78020051	Raccordo a baionetta per 78020050	nr	10



78.03 Articoli copri piscina

Codice	Prodotto	U.m.	Conf.	L	D
78031260	Tenditelo per copri piscina cm 60 con ganci	nr	100	60	8,5

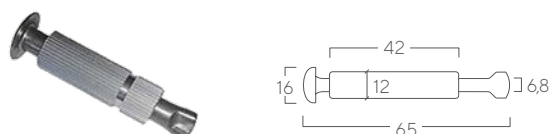

Codice	Prodotto	U.m.	Conf.	L	D
78031265	Chiodo a scomparsa A.I. Ø16 mm cilindro Ø12 mm	nr	50	65	16



Codice	Prodotto	U.M.	Conf.	M	Kg	kN
40032500Al	mm 25 kg 800acciaio inox 304	nr	10	25	800	4

Codice	Prodotto	U.m.	Conf.	M
13702501	mm 25 kg 1200 bianco	ml	100	25



Codice	Prodotto	U.m.	Conf.	L	M	C/R nastro	kN
40010026Al	mm 25 kg 800 nastro bianco cricchetto acciaio inox 304	nr	10	1,5	25	800	4





78.01 Tappi

Codice	Prodotto	U.m.	Conf.
78010600	tappo rosso a vite Ø 34 mm	nr	10
78010500	codulo trasparente Ø 34 mm	nr	10



78.01 Tappi completi

Codice	Prodotto	U.m.	Conf.
78010615	a vite diametro 100 mm con codulo	nr	10





78.10 Stecche rigide PVC

Codice	Prodotto	U.m.	Conf.	Spess.
78102000	stecca rigida pvc ml 2,00 bianca	nr	25	5,3
78102004	stecca rigida pvc ml 2,00 nera	nr	25	5,3
78102500	stecca rigida pvc ml 2,50 bianca	nr	25	5,3
78102504	stecca rigida pvc ml 2,50 nera	nr	25	5,3

Disponibili anche lunghezza ml 3,00 · A richiesta altre misure



78.30 Chiusura a strappo Adesivo

Codice	Prodotto	U.m.	Conf.	L	M
78300200	mm 20 bianco	ml	25	25	20
78300250	mm 25 bianco	ml	25	25	25
78300300	mm 30 bianco	ml	25	25	30
78300380	mm 38 bianco	ml	25	25	38
78300500	mm 50 bianco	ml	25	25	50
78301000	mm 100 bianco	ml	25	25	100

A richiesta altri colori

Codice	Prodotto	U.m.	Conf.	L	M
78300204	mm 20 nero	ml	25	25	20
78300254	mm 25 nero	ml	25	25	25
78300304	mm 30 nero	ml	25	25	30
78300384	mm 38 nero	ml	25	25	38
78300504	mm 50 nero	ml	25	25	50
78301004	mm 100 nero	ml	25	25	100

A richiesta altri colori

A - Asola
U - Uncino





A - Asola

U - Uncino

78.34 Chiusura a strappo Da cucire

Codice	Prodotto	U.m.	Conf.	L	M
78340200	mm 20 bianco	ml	25	25	20
78340250	mm 25 bianco	ml	25	25	25
78340300	mm 30 bianco	ml	25	25	30
78340380	mm 38 bianco	ml	25	25	38
78340500	mm 50 bianco	ml	25	25	50
78341000	mm 100 bianco	ml	25	25	100

A richiesta altri colori / autoestinguente

Codice	Prodotto	U.m.	Conf.	L	M
78340204	mm 20 nero	ml	25	25	20
78340254	mm 25 nero	ml	25	25	25
78340304	mm 30 nero	ml	25	25	30
78340384	mm 38 nero	ml	25	25	38
78340504	mm 50 nero	ml	25	25	50
78341004	mm 100 nero	ml	25	25	100

A richiesta altri colori / autoestinguente



A - Asola

U - Uncino

78.37 Chiusura a strappo Da saldare ad alta frequenza

Codice	Prodotto	U.m.	Conf.	L	M
78370200	mm 20 bianco	ml	25	25	20
78370250	mm 25 bianco	ml	25	25	25
78370300	mm 30 bianco	ml	25	25	30
78370380	mm 38 bianco	ml	25	25	38
78370500	mm 50 bianco	ml	25	25	50
78371000	mm 100 bianco	ml	25	25	100

A richiesta altri colori

Codice	Prodotto	U.m.	Conf.	L	M
78370204	mm 20 nero	ml	25	25	20
78370254	mm 25 nero	ml	25	25	25
78370304	mm 30 nero	ml	25	25	30
78370384	mm 38 nero	ml	25	25	38
78370504	mm 50 nero	ml	25	25	50
78371004	mm 100 nero	ml	25	25	100

A richiesta altri colori



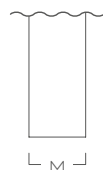

78.30 Velcro® One Wrap® Autobloccante

Codice	Prodotto	U.m.	Conf.	L	M
78302000	mm 20 bianco	ml	25	25	20
78302004	mm 20 nero	ml	25	25	20

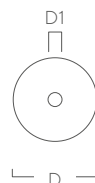
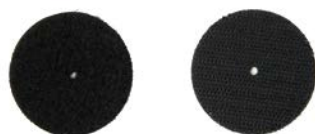

78.39 Disco PVC

Codice	Prodotto	U.m.	Conf.	D	D1
78390454A	Disco PVC 45mm asola con foro nero	nr	100	45	2,5
78390454U	Disco PVC 45mm uncino con foro nero	nr	100	45	2,5

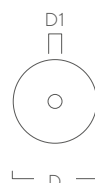

78.39 Disco PVC

Codice	Prodotto	U.m.	Conf.	D	D1
78390500A	Disco PVC 45mm asola con foro bianco	nr	100	45	2,5
78390500U	Disco acetico 45mm ZIGRINATO uncino con foro bianco	nr	100	45	2,5
78390450U	Disco PVC 45mm uncino con foro bianco	nr	100	45	2,5

Dati tecnici Cerniera Spirale e Pressofusa CT 10

	Spirale CT 10 Saldabile	Pressofusa CT 10 Saldabile
Nastro	100% Poliestere termosaldabile	100% Poliestere termosaldabile
Dente	Spirale: 100% Poliestere	Pressofuso: Copolimero acetatico (Pom)
Cucirino	100% Poliestere HT	
Tenuta trazione laterale	Min 130 kg - Max 140 kg	Min 70 kg - Max 75 kg

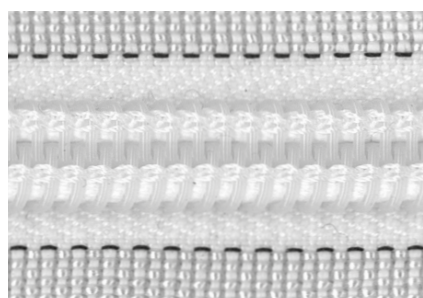

cerniera spirale

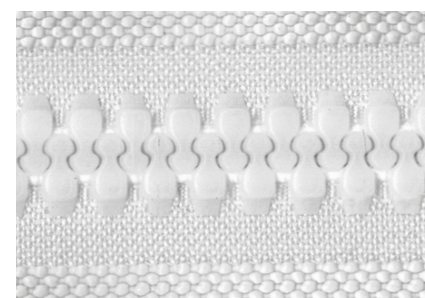

cerniera pressofusa

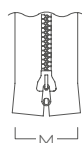

78.40 Cerniere divisibili spirali da cucire Cursore doppio tiretto in tinta

Codice	Colore	Prodotto	U.m.	Conf.	L	M
78400150	bianca	CT 10 cm 150	nr	10	150	40
78400200	bianca	CT 10 cm 200	nr	10	200	40
78400250	bianca	CT 10 cm 250	nr	10	250	40
78400300	bianca	CT 10 cm 300	nr	10	300	40
78400400	bianca	CT 10 cm 400	nr	10	400	40
78400500	bianca	CT 10 cm 500	nr	10	500	40
78400150N	nera	CT 10 cm 150	nr	10	150	40
78400200N	nera	CT 10 cm 200	nr	10	200	40
78400250N	nera	CT 10 cm 250	nr	10	250	40
78400300N	nera	CT 10 cm 300	nr	10	300	40
78400400N	nera	CT 10 cm 400	nr	10	400	40
78400500N	nera	CT 10 cm 500	nr	10	500	40

A richiesta altri colori e misure



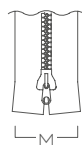

78.40S Cerniere divisibili spirali

Da saldare ad alta frequenza · Corsore doppio tiretto Nichel

Codice	Colore	Prodotto	U.m.	Conf.	L	M
7840S150	bianca	CT 10 cm 150	nr	10	150	53
7840S200	bianca	CT 10 cm 200	nr	10	200	53
7840S220	bianca	CT 10 cm 220	nr	10	220	53
7840S250	bianca	CT 10 cm 250	nr	10	250	53
7840S300	bianca	CT 10 cm 300	nr	10	300	53
7840S350	bianca	CT 10 cm 350	nr	10	350	53
7840S400	bianca	CT 10 cm 400	nr	10	400	53
7840S150N	nera	CT 10 cm 150	nr	10	150	53
7840S200N	nera	CT 10 cm 200	nr	10	200	53
7840S220N	nera	CT 10 cm 220	nr	10	220	53
7840S250N	nera	CT 10 cm 250	nr	10	250	53
7840S300N	nera	CT 10 cm 300	nr	10	300	53
7840S350N	nera	CT 10 cm 350	nr	10	350	53
7840S400N	nera	CT 10 cm 400	nr	10	400	53

A richiesta altre misure

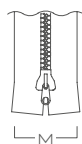

78.42 Cerniere spirali Su rotolo

Codice	Prodotto	U.m.	Conf.	L	M
78420003	bianca CT 03 da cucire	ml	300	300	-
78420003N	nera CT 03 da cucire	ml	300	300	-
78420006	bianca CT 06 da cucire	ml	200	200	32
78420006N	nera CT 06 da cucire	ml	200	200	32
78420006S	bianca CT 06 da saldare *	ml	200	200	32
78420006SN	nera CT 06 da saldare *	ml	200	200	32
78420008	bianca CT 08 da cucire	ml	100	100	35
78420008N	nera CT 08 da cucire	ml	100	100	35
78420010	bianca CT 10 da cucire	ml	100	100	40
78420010N	nera CT 10 da cucire	ml	100	100	40
78420010S	bianca CT 10 da saldare *	ml	100	100	53
78420014S	nera CT 10 da saldare *	ml	100	100	53
78420016S	grigia CT 10 da saldare *	ml	100	100	53

*ad alta frequenza / A richiesta altri colori



78.43 Cursori zama per spirali Doppio tiretto

Codice	Prodotto	U.m.	Conf.
78430010	CT 10 zama bianco	nr	50
78430014	CT 10 zama nero	nr	50



78.43 Cursori per spirali Doppio tiretto

Codice	Prodotto	U.m.	Conf.
78430106	CT 06 nichel	nr	50
78430108	CT 08 nichel	nr	50
78430110	CT 10 nichel da cucire	nr	50
78430110A	CT 10 nichel da saldare	nr	50
78430010NY	CT 10 nylon bianco	nr	50





78.43 Cursori per spirali Singolo tiretto

Codice	Prodotto	U.m.	Conf.
78430003	CT 03 autobloccante zama bianco	nr	50
78430003N	CT 03 autobloccante zama nero	nr	50
78431106	CT 06 nichel	nr	50
78431106N	CT 06 nero	nr	50
78431108	CT 08 nichel	nr	50
78431008	CT 08 zama bianco	nr	50
78431008N	CT 08 zama nero	nr	50
78431110	CT 10 nichel	nr	50
78431110N	CT 10 nero	nr	50
78431110NY	CT 10 nylon bianco	nr	50

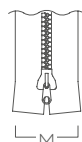

78.40P Cerniere divisibili pressofuse Da cucire · Corsore doppio tiretto in tinta

Codice	Colore	Prodotto	U.m.	Conf.	L	M
7840P150	bianca	CT 10 cm 150	nr	10	150	40
7840P200	bianca	CT 10 cm 200	nr	10	200	40
7840P220	bianca	CT 10 cm 220	nr	10	220	40
7840P250	bianca	CT 10 cm 250	nr	10	250	40
7840P300	bianca	CT 10 cm 300	nr	10	300	40

A richiesta altri colori e misure

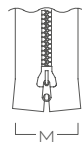

78.41 Cerniere divisibili pressofuse Da saldare ad alta frequenza · Corsore doppio tiretto in tinta

Codice	Colore	Prodotto	U.m.	Conf.	L	M
78410150	bianca	CT 10 cm 150	nr	10	150	40
78410200	bianca	CT 10 cm 200	nr	10	200	40
78410220	bianca	CT 10 cm 220	nr	10	220	40
78410250	bianca	CT 10 cm 250	nr	10	250	40
78410300	bianca	CT 10 cm 300	nr	10	300	40

A richiesta altre misure



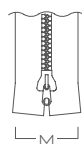

78.41 Cerniere divisibili pressofuse · Da saldare ad alta frequenza Cursore doppio tiretto nero fibra di vetro

Codice	Colore	Prodotto	U.m.	Conf.	L	M
784114200	bianca	CT 14 cm 200	nr	10	200	70
784114220	bianca	CT 14 cm 220	nr	10	220	70
784114250	bianca	CT 14 cm 250	nr	10	250	70
784114300	bianca	CT 14 cm 300	nr	10	300	70

A richiesta colore nero e altre misure

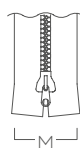
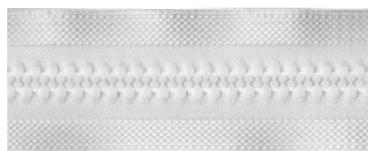

78.42 Cerniere pressofuse Su rotolo

Codice	Prodotto	U.m.	Conf.	L	M
78420108	bianca CT 08 da cucire	ml	100	100	35
78420108N	nera CT 08 da cucire	ml	100	100	35
78420110	bianca CT 10 da cucire	ml	100	100	40
78420110N	nera CT 10 da cucire	ml	100	100	40
78420110S	bianca CT 10 da saldare *	ml	100	100	40
78420114S	bianca CT 14 da saldare *	ml	25	25	70
78420115S	nera CT 14 da saldare *	ml	25	25	70
78420120S	bianca CT 20 da saldare *	ml	25	25	100
78420124S	nera CT 20 da saldare *	ml	25	25	100

*ad alta frequenza

d.t. = doppio tiretto

A richiesta altri colori



78.43 Cursori per pressofuse da cucire Singolo Tiretto

Codice	Prodotto	U.m.	Conf.
784400081	CT08 nichel	nr	50
78431008A	CT08 zama bianco autobloccante	nr	50
78431010	CT10 zama bianco	nr	50





78.44 Cursori per pressofuse da cucire Doppio tiretto

Codice	Prodotto	U.m.	Conf.
78440008	CT 08 zama bianco	nr	50
78440012	CT 10 zama bianco	nr	50
78440012N	CT 10 zama nero	nr	50



78.44 Cursori per pressofuse da saldare Doppio tiretto

Codice	Prodotto	U.m.	Conf.
78440010	CT 10 zama bianco	nr	50



78.44 Cursori per pressofuse da cucire Tiretto

Codice	Prodotto	U.m.	Conf.
78440108	CT 08 nichel doppio tiretto	nr	50
78440110	CT 10 nichel doppio tiretto	nr	50
78441008	CT 08 zama singolo tiretto	nr	50



78.45 Fermi per cerniere

Codice	Prodotto	U.m.	Conf.
78450010	superiore O.N. per CT10 pressofusa	nr	100
78450110	superiore ALL. per CT10 spirale	nr	100
78450111	inferiore ALL. per CT10 spirale	nr	100



78.44 Cursori per pressofuse

Codice	Prodotto	U.m.	Conf.
78440014	doppio tiretto CT 14 fibra di vetro nero	nr	10
78440015	kit montaggio CT 14 bianco composto da: divisibile, fermo e viti	nr	10
78440015N	kit montaggio CT 14 nero composto da: divisibile, fermo e viti	nr	10



78.44 Cursori per pressofuse

Codice	Prodotto	U.m.	Conf.
78440020	doppio tiretto nero CT 20 nylon	nr	10
78440020AI	doppio tiretto CT 20 acciaio inox	nr	10
78440021	kit montaggio CT 20 bianco composto da: divisibile, fermo e viti	nr	10
78440021N	kit montaggio CT 20 nero composto da: divisibile, fermo e viti	nr	10



78.45 Dentini di ricambio

Codice	Prodotto	U.m.	Conf.
78450022NY	dentino nero ricambio con vite per CT20 e CARGOPLUS	A	nr 10
78450022NY1	dentino nero ricambio con vite per CT20 e CARGOPLUS	B	nr 10
78450023NY	dentino nero ricambio con vite per RH Zip	C	nr 10



settantotto

→ zip speciali per chiusure trasparenti
schermanti e oscuranti

cod. 78480054
semicatena mm16
2x1 grigia/grey

cod. 78480055
semicatena mm16
2x1 bianca/white

cod. 78480057
semicatena mm16
2x1,5 bianca/white

cod. 78480058
semicatena mm16
2x1,5 grigia/grey

Ingombro zero

rotolo mt 300

saldabile ad alta frequenza

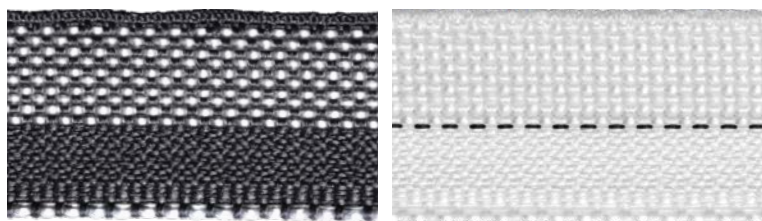

Composizione:

Nastro	100% poliestere ordito PVC
Cordonetto	100% poliestere
Cucirino	100% poliestere

Prova di tenuta trazione laterale

Forza	130 kg
-------	--------

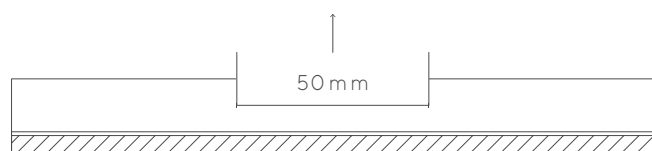

Ingombro zero · spalmata colla PU

rotolo mt 300

saldabile ad alta frequenza e aria calda

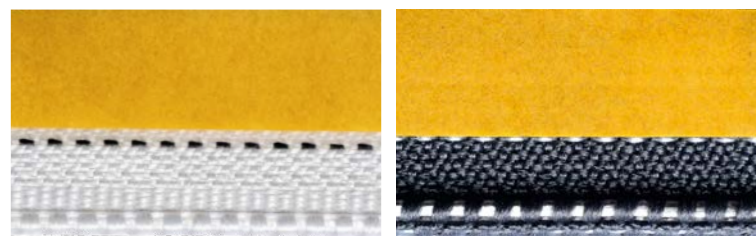

Composizione:

Nastro	100% poliestere + colla PU
Cordonetto	100% poliestere
Cucirino	100% poliestere

Prova di tenuta trazione laterale

Forza	130 kg
-------	--------

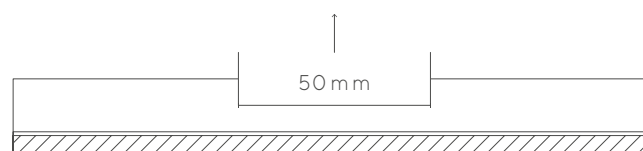

settantotto

→ zip speciali per chiusure trasparenti
schermanti e oscuranti

cod. 78480015

Nyguard 4

rotolo mt 200

nastro thermo-pvc nero
saldabile ad alta frequenza

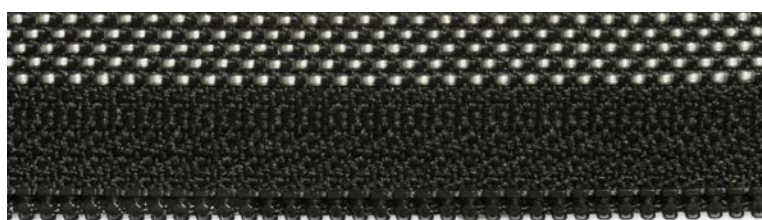

Composizione:

Nastro	poliestere testurizzato
Dente	poliammide 6
Cucirino	poliestere Tit.80/3Nm

Prova di tenuta trazione laterale (no semicatena)

Forza 75 kg

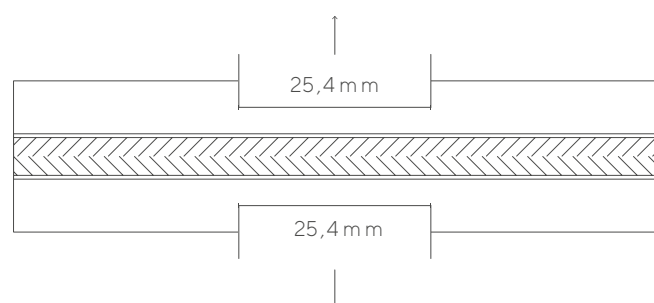

cod. 78480025
CT4 saldabile bianca
CT4 weldable white

CT4 saldabile

rotolo mt 200

saldabile ad alta frequenza
a richiesta oscurante (fig. 2)



fig.1



fig.2

Composizione:

Nastro	100% poliestere
Catena	monofilo 100% poliestere
Cucirino	100% poliestere ad alta tenacità

Prova di tenuta trazione laterale (no semicatena)

Forza 60 kg

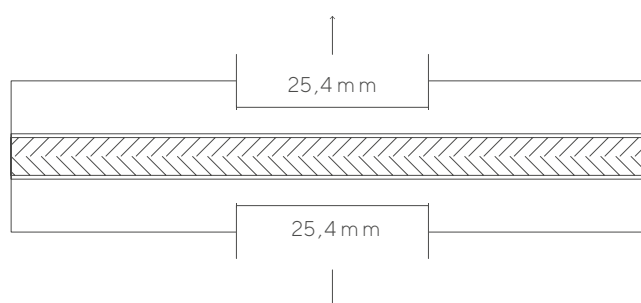

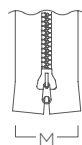

78.49 Cerniere divisibili YKK® pressofuse Cursore nylon · Doppio tiretto autoblock · Da cucire

Codice	Prodotto	Colore	U.m.	Conf.	L	M
78492050	CT 10 cm 50	bianca 501	nr	10	50	38
78492050B	CT 10 cm 50	blu 560	nr	10	50	38
78492050N	CT 10 cm 50	nera 580	nr	10	50	38
78492050A	CT 10 cm 50	beige 573	nr	10	50	38
78492100	CT 10 cm 100	bianca 501	nr	10	100	38
78492100B	CT 10 cm 100	blu 560	nr	10	100	38
78492100N	CT 10 cm 100	nera 580	nr	10	100	38
78492100A	CT 10 cm 100	beige 573	nr	10	100	38
78492150	CT 10 cm 150	bianca 501	nr	10	150	38
78492150B	CT 10 cm 150	blu 560	nr	10	150	38
78492150N	CT 10 cm 150	nera 580	nr	10	150	38
78492150A	CT 10 cm 150	beige 573	nr	10	150	38
78492200	CT 10 cm 200	bianca 501	nr	10	200	38
78492200B	CT 10 cm 200	blu 560	nr	10	200	38
78492200N	CT 10 cm 200	nera 580	nr	10	200	38
78492200A	CT 10 cm 200	beige 573	nr	10	200	38
78492250	CT 10 cm 250	bianca 501	nr	10	250	38
78492250B	CT 10 cm 250	blu 560	nr	10	250	38
78492250N	CT 10 cm 250	nera 580	nr	10	250	38
78492250A	CT 10 cm 250	beige 573	nr	10	250	38
78492300	CT 10 cm 300	bianca 501	nr	10	300	38
78492300B	CT 10 cm 300	blu 560	nr	10	300	38
78492300N	CT 10 cm 300	nera 580	nr	10	300	38
78492300A	CT 10 cm 300	beige 573	nr	10	300	38
78492350	CT 10 cm 350	bianca 501	nr	10	350	38
78492350B	CT 10 cm 350	blu 560	nr	10	350	38
78492350N	CT 10 cm 350	nera 580	nr	10	350	38
78492350A	CT 10 cm 350	beige 573	nr	10	350	38
78492400	CT 10 cm 400	bianca 501	nr	10	400	38
78492400B	CT 10 cm 400	blu 560	nr	10	400	38
78492400A	CT 10 cm 400	beige 573	nr	10	400	38
78492450	CT 10 cm 450	bianca 501	nr	10	450	38
78492450B	CT 10 cm 450	blu 560	nr	10	450	38
78492450A	CT 10 cm 450	beige 573	nr	10	450	38
78492500	CT 10 cm 500	bianca 501	nr	10	500	38
78492500B	CT 10 cm 500	blu 560	nr	10	500	38
78492500A	CT 10 cm 500	beige 573	nr	10	500	38
78492550	CT 10 cm 550	bianca 501	nr	10	550	38
78492550A	CT 10 cm 550	beige 573	nr	10	550	38
78492600	CT 10 cm 600	bianca 501	nr	10	600	38
78492600A	CT 10 cm 600	beige 573	nr	10	600	38
78492700	CT 10 cm 700	bianca 501	nr	10	700	38
78492700A	CT 10 cm 700	beige 573	nr	10	700	38



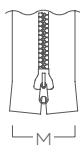

78.49 Cerniere divisibili YKK® pressofuse
Doppio tiretto libero zama · Da cucire

Codice	Prodotto	Colore	U.m.	Conf.	L	M
78491050	CT 08 cm 50	bianca 501	nr	10	50	34
78491050B	CT 08 cm 50	blu 560	nr	10	50	34
78491050N	CT 08 cm 50	nera 580	nr	10	50	34
78491100	CT 08 cm 100	bianca 501	nr	10	100	34
78491100B	CT 08 cm 100	blu 560	nr	10	100	34
78491100N	CT 08 cm 100	nera 580	nr	10	100	34
78491150	CT 08 cm 150	bianca 501	nr	10	150	34
78491150B	CT 08 cm 150	blu 560	nr	10	150	34
78491150N	CT 08 cm 150	nera 580	nr	10	150	34
78491200	CT 08 cm 200	bianca 501	nr	10	200	34
78491200B	CT 08 cm 200	blu 560	nr	10	200	34
78491200N	CT 08 cm 200	nera 580	nr	10	200	34
78491250	CT 08 cm 250	bianca 501	nr	10	250	34
78491250B	CT 08 cm 250	blu 560	nr	10	250	34
78491250N	CT 08 cm 250	nera 580	nr	10	250	34
78491300	CT 08 cm 300	bianca 501	nr	10	300	34
78491300B	CT 08 cm 300	blu 560	nr	10	300	34
78491300N	CT 08 cm 300	nera 580	nr	10	300	34
78491350	CT 08 cm 350	bianca 501	nr	10	350	34
78491350B	CT 08 cm 350	blu 560	nr	10	350	34
78491350N	CT 08 cm 350	nera 580	nr	10	350	34
78491400	CT 08 cm 400	bianca 501	nr	10	400	34
78491400B	CT 08 cm 400	blu 560	nr	10	400	34
78491400N	CT 08 cm 400	nera 580	nr	10	400	34
78491450	CT 08 cm 450	bianca 501	nr	10	450	34
78491450B	CT 08 cm 450	blu 560	nr	10	450	34
78491450N	CT 08 cm 450	nera 580	nr	10	450	34

A richiesta altre misure

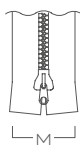

78.49 Cerniere divisibili YKK® pressofuse
Doppio tiretto autoblock · Da cucire

Codice	Prodotto	Colore	U.m.	Conf.	L	M
784905050	CT 05 cm 50	bianca 501	nr	10	50	30
784905100	CT 05 cm 100	bianca 501	nr	10	100	30
784905150	CT 05 cm 150	bianca 501	nr	10	150	30
784905200	CT 05 cm 200	bianca 501	nr	10	200	30
784905250	CT 05 cm 250	bianca 501	nr	10	250	30
784905300	CT 05 cm 300	bianca 501	nr	10	300	30
784905350	CT 05 cm 350	bianca 501	nr	10	350	30



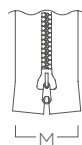

78.49 Cerniere divisibili YKK® pressofuse Nautica · Da cucire - su rotolo

Codice	Prodotto	U.m.	Conf.	L	M
78490005	CT05 bianca 501	ml	100	100	30
78490008	CT08 bianca 501	ml	100	100	34
78490008B	CT08 blu 560	ml	100	100	34
78490008N	CT08 nera 580	ml	100	100	34
78490000	CT10 bianca 501	ml	100	100	38
78490000B	CT10 blu 560	ml	100	100	38
78490000N	CT10 nera 580	ml	100	100	38
78490000G	CT10 grigia 577	ml	100	100	38



78.49 Cursori YKK® per pressofuse Da cucire

Codice	Prodotto	U.m.	Conf.
78490050	nylon doppio tiretto autoblock CT05 bianco	nr	10
78490051	nylon singolo tiretto autoblock CT05 bianco	nr	10
78490080	nylon singolo tiretto autoblock CT08 bianco	nr	10
78490081	zama singolo tiretto libero CT08 bianco	nr	10
78490084	nylon singolo tiretto autoblock CT08 nero	nr	10
78490084L	zama singolo tiretto libero CT08 nero	nr	10
78490082	zama doppio tiretto libero CT08 bianco	nr	10
78490082N	zama doppio tiretto libero CT08 nero	nr	10
78490082R	nichel singolo tiretto reversibile CT08	nr	10
78490010	nylon singolo tiretto autoblock CT10 bianco	nr	10
78490010A	nylon singolo tiretto autoblock CT10 beige	nr	10
78490010B	nylon singolo tiretto autoblock CT10 blu	nr	10
78490010N	nylon singolo tiretto autoblock CT10 nero	nr	10
78490012	nylon doppio tiretto autoblock CT10 bianco	nr	10
78490012N	nylon doppio tiretto autoblock CT10 nero	nr	10
78490012B	nylon doppio tiretto autoblock CT10 blu	nr	10
78490012G	nylon doppio tiretto autoblock CT10 grigio	nr	10



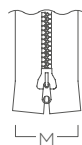

78.49 Cerniere YKK® spirali Da cucire - su rotolo

Codice	Prodotto	U.m.	Conf.	L	M
78496005	CT4.5 - bianca 501	ml	100	100	28
78496006	CT06 - bianca 501	ml	100	100	32
78496006N	CT06 - nera 580	ml	100	100	32
78496008	CT08 - bianca 501	ml	100	100	33
78496008N	CT08 - nera 580	ml	100	100	33
78496010	CT10 - bianca 501	ml	100	100	38
78496010B	CT10 - blu 560	ml	100	100	38
78496010N	CT10 - nera 580	ml	100	100	38



A



B

78.49 Cursori YKK® per spirali Da cucire

Codice	Prodotto	U.m.	Conf.
78496610	doppio tiretto libero nichel CT10	A	nr 10
78496611	singolo tiretto libero nichel CT10	A	nr 10
78496641NY	singolo tiretto libero nylon CT4.5	B	nr 10
78496651NY	singolo tiretto libero nylon CT06	B	nr 10
78496681	doppio tiretto libero nichel CT08	A	nr 10



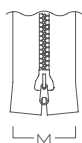

78.42 Cerniere pressofuse Da saldare ad alta frequenza

Codice	Prodotto	U.m.	Conf.	L	M
78420114S	CT14 col. bianco	ml	25	25	70
78420115S	CT14 col. nero	ml	25	25	70
78440014	cursore doppio tiretto fibra di vetro nero	nr	10		
78440015	kit montaggio bianco	nr	10		
78440015N	kit montaggio nero	nr	10		

78.42 Cerniere pressofuse Da saldare ad alta frequenza

Codice	Prodotto	U.m.	Conf.	L	M
78420120S	CT20 col. bianco	ml	25	25	100
78420124S	CT20 col. nero	ml	25	25	100
78440020	cursore doppio tiretto nylon nero	nr	10		
78440020AI	cursore doppio tiretto acciaio inox	nr	10		
78440021	kit montaggio bianco	nr	10		
78440021N	kit montaggio nero	nr	10		
78450022NY	dentino di ricambio nero	nr	10		

78.42 Cerniere CT 30

Codice	Prodotto	U.m.	Conf.	M
78420134S	pressofusa da saldare/cucire	ml	10	100
78440030	cursore doppio tiretto Nylon	nr	1	
78440030AI	cursore doppio tiretto acciaio inox	nr	1	
78440031	kit montaggio composto da: divisibile, fermo e viti	nr	1	
78440032	kit riparazione CT30 composto da 10 denti, viti e dadi + attrezzo foratura	nr	1	

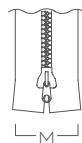
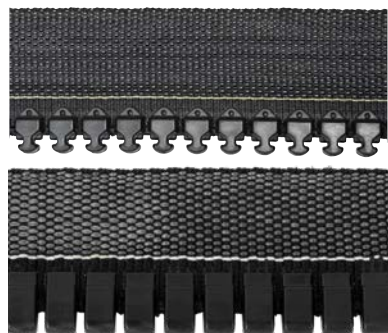

78.45 Zip per portoni industriali

Codice	Prodotto	U.m.	Conf.	M
78450040P	pressofusa da saldare	mt	100	54
78450040RX	RH Zip dente rettangolare	mt	100	35



Codice	Prodotto	U.m.	Conf.
78450022NY	dentino nero ricambio con vite per CT20 e CARGOPLUS	A	nr 10
78450022NY1	dentino nero ricambio con vite per CT20 e CARGOPLUS	B	nr 10
78450023NY	dentino nero ricambio con vite per RH Zip	C	nr 10

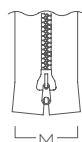

78.45 Zip Nyseal CT 08

Codice	Prodotto	U.m.	Conf.	M
78452100	spirale rivestita TPU (poliuretano) A tenuta d'aria, resistenza alla pressione dell'aria 6-10 kpa Impermeabile	a richiesta	40	



Retro



Fronte



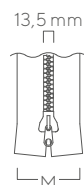

78.45 ZIP AIR

Codice	Prodotto	U.m.	Conf.	M
78453000	tenuta stagna* cursore fibra di vetro		a richiesta	70

* da cucire - saldabile - incollabile a neoprene
Prodotto solo su richiesta

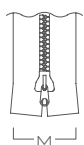

78.45 Cerniera REFRESH CT 40

Codice	Prodotto	U.m.	Conf.	M
78456000	pressofusa da saldare cursore acciaio inox		a richiesta	130
78456020	cursore inox		a richiesta	
78456030	fermo inox		a richiesta	

Prodotto solo su richiesta

Dati tecnici Cerniera CT 14 - 20 - 30 - 40 Refresh

	CT 14 su nastro termosaldabile	CT 20 su nastro termosaldabile	CT 30 su nastro termosaldabile	CT 40 su nastro termosaldabile
Nastro	100% poliestere tinto in pasta HT ricoperto PVC	100% poliestere tinto in pasta HT ricoperto PVC	100% poliestere tinto in pasta HT ricoperto PVC	100% poliestere doppio strato tinto in pasta HT ricoperto PVC Membrana di tenuta interna Poliuretano / Poliestere
Vite di tenuta	-	-	-	Acciaio inossidabile
Dente pressoiniettato	Copolimero acetalico (Pom)	Copolimero acetalico (Pom)	Copolimero acetalico (Pom)	Copolimero acetalico (Pom)
Tenuta trazione trasversale (su mm 50)	140 kg	220 kg	330 kg	1250 kg



78.50

Filo per cucire Rasant Oxella

65% poliestere rivestito 35% cotone
A richiesta: filo idrorepellente

Codice	Prodotto	U.m.	Conf.	L
78501100	titolo 11	rt	4	1.100
78501500	titolo 15	rt	4	1.400
78502000	titolo 20	rt	4	2.000
78502500	titolo 25	rt	4	2.750
78503000	titolo 30	rt	4	2.500
78503500	titolo 35	rt	4	4.000
78505000	titolo 50	rt	4	5.000
78507500	titolo 75	rt	4	5.000
78512000	titolo 120	rt	4	5.000

11,15,20 25 30		11,15,20 25 30		11,15,20 25 30	
2000	. . .	1098		277	. .
1000	.	1617	.	262	.
3000	. . .	1621	. .	1245	. . .
661	.	420		3147	
120		358	. .	1052	. . .
800	. .	3150	. .	1157	.
2260		863	. .	7086	.
508	.	672	. .	6213	
2427	. . .	3148		1069	. . .
2900	. .	372	.	1277	. . .
2076	. . .	1630	. .	978	. .
1056		7243	. . .	3144	.
2052		671	. . .	5667	.
578	.	766	.	191	. .
3640	.	3146		107	. . .
3622	. .	972	. . .	1629	. . .
1276	.	859	.	119	. .
3145		831	.	1238	
3555	. . .	1504	.	136	. . .
3143	.	849	.	4000	. . .



78.60

Filo per cucire Saba

100% Poliestere

Codice	Prodotto	U.m.	Conf.	L
78602500	titolo 25	rt	5	5.000
78603000	titolo 30	rt	4	3.000
78603500	titolo 35	rt	4	5.000
78605000	titolo 50	rt	5	2.500
78608000	titolo 80	rt	5	5.000
78610000	titolo 100	rt	5	5.000
78612000	titolo 120	rt	5	5.000

saba^C 35
100% polyester



78.70

Filo per cucire Serafil

100% poliestere multifilamento
A richiesta: filo idrorepellente

• Serafil
10, 15, 20 WR, 40 WR

Codice	Prodotto	U.m.	Conf.	L
78701000	titolo 10	rt	4	1.000
78701500	titolo 15	rt	5	450
78702000	titolo 20	rt	4	2.500
78703000	titolo 30	rt	4	4.000

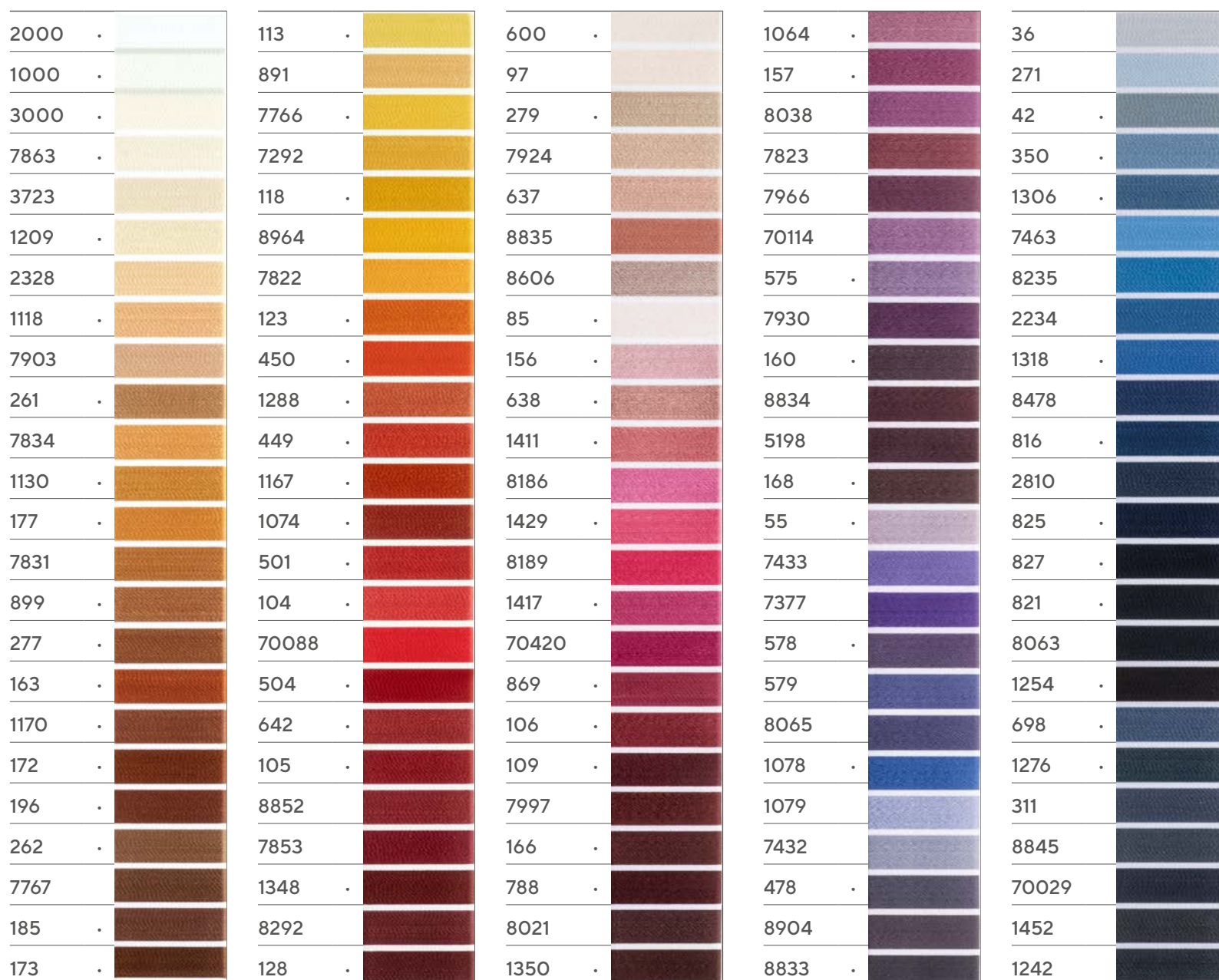

78.70

Filo per cucire Serafil

• Serafil
10, 15, 20 WR, 40 WR

8470		1090		565		475		411	
1394		1095		269		1228		321	
8842		91		1456		8059		412	
359		1148		971		397		70115	
760		466		465		1380		316	
485		839		380		1182		340	
8022		92		267		186		850	
764		8190		379		975		318	
425		842		1227		1224		1476	
20		1210		3225		8577		1358	
70188		1185		770		8060		414	
1091		8844		326		264		415	
1397		667		861		3548		416	
70118		182		779		8929		1361	
1314		1043		265		428		324	
70268		663		8073		399		3437	
239		8324		7769		7770		8861	
7498		290		1222		976		1282	
244		114		7862		1382		1283	
8973		1102		287		1002		8061	
1097		8843		281		1003		4000	
757		8837		3542		7768		1426	
846		7832		1223		1050		1427	
55		7971		175		8893		1428	

78.72

Filo per cucire Tenara®

ePTFE (politetrafluoroetilene espanso)

Codice	Prodotto	U.m.	Conf.	L
78720000	neutro	rt	1	1.750

Realizzato in PTFE espanso (politetrafluoroetilene) per cucitura ad alta velocità.

Garanzia di 15 anni*

- Supera la resistenza dei fili in poliestere e in cotone/poliestere
- Resiste per l'intera durata del tessuto
- Resiste ai raggi UV e agli agenti atmosferici
- Resiste alle radiazioni UV della luce solare
- Resiste agli effetti negativi degli agenti atmosferici, inclusa l'acqua dolce e salata
- Non si deteriora né decompone

Resistenza chimica

- Resiste agli effetti negativi di piogge acide e inquinanti industriali
- Resiste a sbiancanti a base di cloro e a soluzioni pulenti

Resistenza allo scolorimento

- I colori universali "CLEAR" si abbinano a molti tipi di tessuto.
- Disponibili colori accesi, che non scoloriscono, per abbinamento con molti tipi di tessuto.

GORE™ TENARA® Filo per cuciture TR STYLE - CLEAR

CODICE ARTICOLO	DENSITÀ LINEARE (denier/dtex)	EQUIVALENTE POLIESTERE APP. (Nm)	RESISTENZA ALLA ROTTURA NOMINALE (cN)	RESA (m/bobine)	MISURA AGO CONSIGLIATA (Nm)	LUBRIFICANTE CERA AL SILICONE	ELASTICITÀ NOMINALE (%)
M1000LTR-L-5	1000/1111	50/60	3114	2100	90-110	sì	17
M1000KTR-L-5	1400/1556	35/40	4448	1750	100-120	sì	17
M1000HKTR-L-5	2800/3111	20/25	8452	875	120-140	sì	17
M1000XHTR	4800/5333	15	13789	900	Consultare il costruttore della macchina	no	12

GORE™ TENARA® Filo per cuciture TR STYLE - COLOURS

CODICE ARTICOLO	DENSITÀ LINEARE (denier/dtex)	EQUIVALENTE POLIESTERE APP. (Nm)	RESISTENZA ALLA ROTTURA NOMINALE (cN)	RESA (m/bobine)	MISURA AGO CONSIGLIATA (Nm)	LUBRIFICANTE CERA AL SILICONE	ELASTICITÀ NOMINALE (%)
M1000TR-(XX)-5	1400/1556	35/40	3559	1750	100-120	sì	17
M1000HTR-(XX)-5	2800/3111	20/25	6228	875	120-140	sì	17

Per ordinare i fili per cuciture GORE™ TENARA® colorati sostituire "XX" con il codice del colore: WH (bianco), LB (azzurro), CB (blu chesapeake), YW (giallo), RG (arancione), RD (rosso), FG (verde foresta), GY (grigio), LG (grigio chiaro), BR (marrone cioccolato), BK (nero)

Europa/Medio Oriente/Africa
W. L. GORE & ASSOCIATES GMBH
Wernher-von-Braun-Straße 18 • D-85640 Putzbrunn • Germania
Tel.: +49 89 4612-2211 • Fax: +49 89 4612-2306 • E-mail: ipd-deutschland@wigore.com

USA/Canada/Estremo Oriente/America Latina/Sud America
W. L. GORE & ASSOCIATES, INC.
100 Airport Road • P. O. Box 1010 • Elkton, MD 21921-1010 • USA
Tel.: +1 410-392-3200 • Fax: +1 410-506-8445 • E-mail: info@wigore.com

Cina
GORE INDUSTRIAL PRODUCTS TRADE (SHANGHAI) Co., Ltd.
Floor 43, United Plaza • 1468 Nanjing Road West • Shanghai 200040 • Cina
Tel.: +86-21-6247-1999 • Fax: +86-21-6247-9199 • E-mail: info_china@wigore.com

gore.com/tenara

* Per i dettagli relativi alle condizioni di garanzia vedere relativa scheda separata. Tutte le informazioni tecniche e i consigli indicati si basano sulla nostra precedente esperienza. Forniamo queste informazioni sulla base delle nostre migliori conoscenze, ma non ci assumiamo responsabilità legale per quanto indicato. I dati operativi forniti sono stati determinati in condizioni tecniche ideali. Ogni deviazione da tali dati dipende dalle condizioni della singola applicazione e dal rispetto delle nostre istruzioni di cucitura e di procedimento. Per ottenere risultati ottimali consigliamo di consultare i nostri specialisti di prodotto, fornendo loro tutti i dettagli dell'applicazione in questione. I nostri tecnici saranno lieti di aiutarvi. Le specifiche sono soggette a modifiche, che vengono applicate senza preavviso. GORE, Tenara e i relativi progetti sono marchi commerciali di W. L. Gore & Associates, © di W. L. Gore & Associates GmbH, 2007.



78.81

Filo per cucire OutdoorPro Waterproof

- Poliestere filamento continuo bonderizzato
- Che si tratti di tende da sole, coperture per barche, mobili da esterno o scarpe, Outdoor-Pro è il filo per cucire ideale per i prodotti da esterno
- Dotazione standard di finitura PFC-free WRe
- Colori brillanti, aspetto tessile
- Particolarmente adatto per cuciture multidirezionali
- Eccellente resistenza ai raggi UV grazie a tinture speciali
- Test d'invecchiamento secondo ISO 4892-1 e ISO 4892-2 (DIN EN ISO 12402-7) e conservazione a freddo a -30°C Nuovo

Codice	Prodotto	U.m.	Conf.	L	Tex no.	Misura ago	
						Nm	No
7881100	titolo 10*	rt	4	1.400	270	200-220	25-26
7881150	titolo 15*	rt	4	1.900	210	180-200	24-25
7881200	titolo 20	rt	4	1.500	135	130-160	21-23
7881300	titolo 30	rt	4	2.300	90	110-130	18-21

*solo su richiesta

Nat. White	7003U		Dark Olive	7567U	
Creme	7600U		Sand	7680U	
Sunflower Gold	7466U		Sandstone	7622U	
Ochre	7477U		Olive Brown	7654U	
Orange	7800U		Beaver	7582U	
Toboggan	7890U		Saddle	7719U	
Magma	7904U		Nutmeg	7762U	
Red	7905U		Brown	7765U	
Burgundy	7997U		Bay Brown	7793U	
Black Cherry	7983U		Storm Grey	7077U	
Pacific Blue	8421U		Cloudy Grey	7069U	
Mediterranean	8403U		Pearl Grey	7070U	
Royal Blue	8578U		Shark Grey	7090U	
Marine Blue	8555U		Charcoal	7115U	
Navy	8566U		Med. Steel	7113U	
Forest Green	8847U		Graphite	7182U	
Seagrass Green	8857U		Black	7020U	

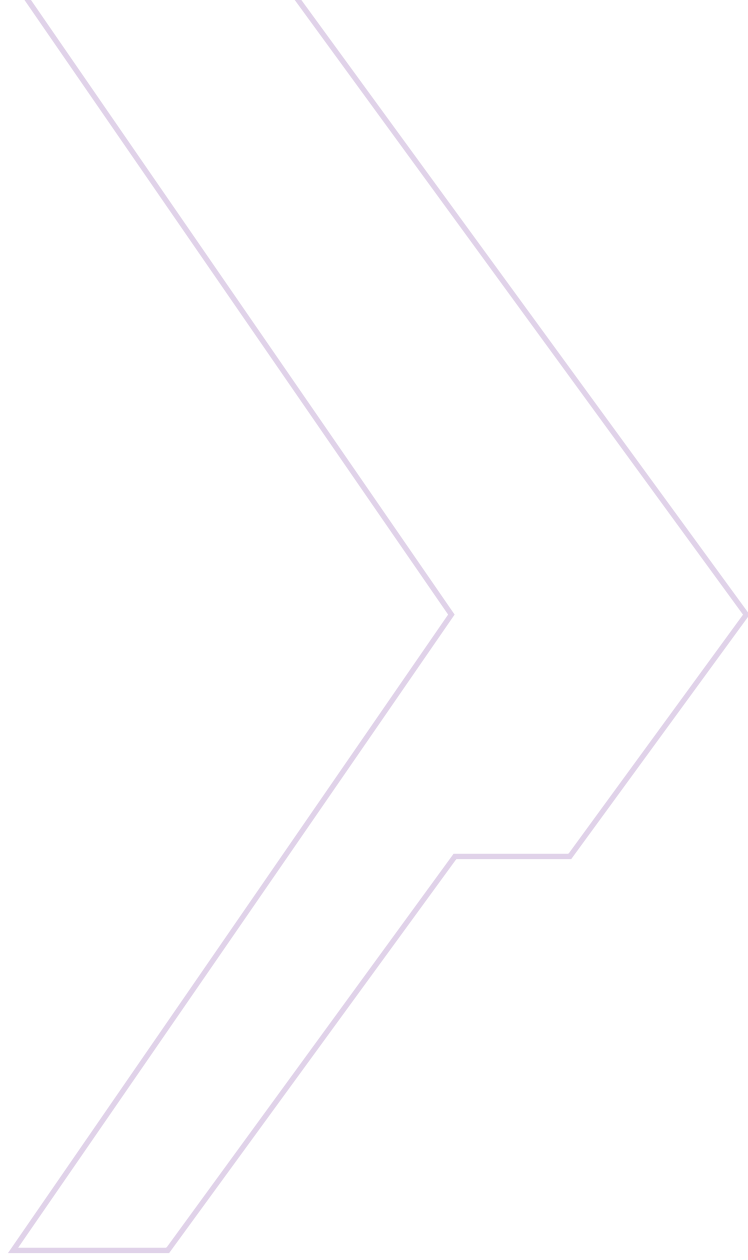

/
OTTANTA

Punzoni





80.01 Punzoni a martello tondi

Codice	Prodotto	U.m.	Conf.	D
80010831	VL 31	nr	1	8
80011040	VL 40	nr	1	10
80011250	VL 50	nr	1	12
80011460	VL 60	nr	1	14
80011670	VL 70	nr	1	16
80011880	VL 80	nr	1	18
80012400	VL 100	nr	1	24
8001100E	mm 10 DIN	nr	1	10
8001120E	mm 12 DIN	nr	1	12
8001140E	mm 14 DIN	nr	1	14
8001160E	mm 16 DIN	nr	1	16
8001180E	mm 18 DIN	nr	1	18
8001200E	mm 20 DIN	nr	1	20
8001250E	mm 25 DIN	nr	1	25
8001380E	mm 38 e VL 150	nr	1	38



80.02 Punzoni a martello rivetti

Codice	Prodotto	U.m.	Conf.
80020800	senza ricambio	nr	1
80491100	ricambio per rivetti 33	nr	1
80491101	ricambio per rivetti 36	nr	1
80491102	ricambio per rivetti 37	nr	1

Codice	Prodotto	U.m.	Conf.
80020801	per autopercoranti	nr	1





80.02 Punzoni a martello turniquet

Codice	Prodotto	U.m.	Conf.	L	M
80020814	occhiello 05060402	nr	1	15	9
80021711	occhiello 05060702/802	nr	1	17	11
80021811	occhiello 05060502	nr	1	19,5	12
80022213	occhiello 05060202/302/602	nr	1	22,5	13,5



80.02 Punzoni a martello vari

Codice	Prodotto	U.m.	Conf.	L	M
80022708	jeep rettangolare	nr	1	27	8
80023808	rettangolare	nr	1	38	8
80023105	jeep ovale	nr	1	27	7



80.02 Punzoni a martello TIR ovali

Codice	Prodotto	U.m.	Conf.	L	M
80024010	mm 40x10	nr	1	40	10
80024222	mm 42x22 - mm 40x20	nr	1	42	22



80.07 Punzoni a martello capicorda

Codice	Prodotto	U.m.	Conf.
80070681	freccia	nr	1

Codice	Prodotto	U.m.	Conf.
80070682	porta freccia Ø 6	nr	1
80070686	porta freccia Ø 8	nr	1

Codice	Prodotto	U.m.	Conf.
80070683	punzone Ø 6 - 8	nr	1

Codice	Prodotto	U.m.	Conf.
80070684	base Ø 6	nr	1
80070685	base Ø 8	nr	1



LO
D

80.11 Fustelle a martello tonde

Codice	Prodotto	U.m.	Conf.	D
80110300	mm 03	nr	1	3
80110831	mm 08	nr	1	8
80111040	mm 10	nr	1	10
80111250	mm 12	nr	1	12
80111460	mm 14	nr	1	14
80111670	mm 16	nr	1	16
80111880	mm 18	nr	1	18
80112000	mm 20	nr	1	20
80112400	mm 24	nr	1	24
80112500	mm 25	nr	1	25
80113800	mm 38	nr	1	38
80114015	mm 40	nr	1	40

Altre misure a richiesta





80.12 Fustelle a martello varie

Codice	Prodotto	U.m.	Conf.	L	M
80120814	occhiello 05060402	nr	1	15	9
80121711	occhiello 05060702/802	nr	1	17	11
80121811	occhiello 05060502	nr	1	19,5	12
80122213	occhiello 05060202/302/602	nr	1	22,5	13,5
80122205	fori campanella copri/scopri	nr	1	24	5
80122708	jeep rettangolare	nr	1	27	8
80123808	rettangolare	nr	1	38	8
80123105	jeep ovale	nr	1	31	5
80124010	tir ovale	nr	1	40	10
80124222	tir ovale	nr	1	42	22



80.17 Fustelle a martello varie

Codice	Prodotto	U.m.	Conf.	A
80170301	cavallotto inter. mm 56 senza ricambio	nr	1	56
80170302	cavallotto inter. mm 51 senza ricambio	nr	1	51
80170303	cavallotto inter. mm 34 senza ricambio	nr	1	34

Codice	Prodotto	U.m.	Conf.	A
80170705	gancio nylon inter. mm 20 senza ricambio	nr	1	20

Codice	Prodotto	U.m.	Conf.
80172400	carrello 25022400 senza ricambio	nr	1
80172402	carrello 250224402/ganci 070510CD senza ricambio	nr	1

Ricambi da abbinare:

Codice	Prodotto	U.m.	Conf.	D
80490300	ricambio filettato mm 3 per fustella	nr	1	3
80490400	ricambio filettato mm 4 per fustella	nr	1	4
80490500	ricambio filettato mm 5 per fustella	nr	1	5



80.17 Fustelle a martello DOT

Codice	Prodotto	U.m.	Conf.
80170510	fustella dot per 05060112	nr	1
80170512	fustella dot per 05060115	nr	1



80.17 Fustelle a martello varie

Codice	Prodotto	U.m.	Conf.	A
80175028	prontocar int. mm 28 senza ricambio	nr	1	28

Ricambi da abbinare:

Codice	Prodotto	U.m.	Conf.	D
80490550	fustella attacco d. 10 forat. mm 5	nr	1	5
80490600	fustella attacco d. 10 forat. mm 6	nr	1	6
80490750	fustella attacco d. 10 forat. mm 7,5	nr	1	7,5



80.31 Punzoni per torchio tondi

Codice	Prodotto	U.m.	Conf.	D
80310831	mm 08	nr	1	8
80311040	mm 10	nr	1	10
80311250	mm 12	nr	1	12
80311460	mm 14	nr	1	14
80311670	mm 16	nr	1	16
80311880	mm 18	nr	1	18
80312400	mm 24	nr	1	24
80314000	mm 38	nr	1	38



80.32 Punzoni per torchio 85019201/203

Codice	Prodotto	U.m.	Conf.	D
80321250	mm 12	nr	1	12
80321460	mm 14	nr	1	14



80.33 Punzoni per torchio 85019201/203 Per occhielli stampa digitale

Codice	Prodotto	U.m.	Conf.	D
80331001	#1 mm 08 filetto/attacco Europeo	nr	1	8
80331001A	#1 mm 08 filetto/attacco Americano	nr	1	8
80331002	#2 mm 9,4 filetto/attacco Europeo	nr	1	9,4
80331002A	#2 mm 9,4 filetto/attacco Americano	nr	1	9,4
80331003	#3 mm 11,6 filetto/attacco Europeo	nr	1	11,6
80331003A	#3 mm 11,6 filetto/attacco Americano	nr	1	11,6
80331004	#4 mm 14,5 filetto/attacco Europeo	nr	1	14,5
80331004A	#4 mm 14,5 filetto/attacco Americano	nr	1	14,5
80331005	#5 mm 18,2 filetto/attacco Europeo	nr	1	18,2
80331005A	#5 mm 18,2 filetto/attacco Americano	nr	1	18,2



80.37 Punzoni per torchio vari DOT e Turniquet

Codice	Prodotto	U.m.	Conf.	L	M
80370040	bottoni Dot parte inferiore	nr	1		
80370041	bottoni Dot parte superiore	nr	1		
80371509	occhiello turniquet 05060402	nr	1	15	9
80371912	occhiello turniquet 05060502	nr	1	19,5	12
80372213	occhiello turniquet 05060302	nr	1	22	13
80371711	occhiello turniquet 05060802	nr	1	17	11





80.37 Punzoni per torchio bottoni

Codice	Prodotto	U.m.	Conf.	D
80371500A	testa mm 15	nr	1	15
80371700A	testa mm 17	nr	1	17

Codice	Prodotto	U.m.	Conf.
80371500B	molla	nr	1

Codice	Prodotto	U.m.	Conf.
80371500C	godronato	nr	1

Codice	Prodotto	U.m.	Conf.
80371500D	olgo	nr	1



80.41 Fustelle per torchio

Codice	Prodotto	U.m.	Conf.	D
80410831A	mm 08 VL 31	nr	1	8
80411040A	mm 10 VL 40	nr	1	10
80411250A	mm 12 VL 50	nr	1	12
80411460A	mm 14 VL 60	nr	1	14
80411670A	mm 16 VL 70	nr	1	16
80411880A	mm 18 VL 80	nr	1	18
80414000	mm 40 VL 150	nr	1	40



80.42 Fustelle per torchio a sfera

Codice	Prodotto	U.m.	Conf.	D
80420831	VL 31	nr	1	8
80420940	VL 40	nr	1	9
80421150	VL 50	nr	1	10
80421360	VL 60	nr	1	13
80421470	VL 70	nr	1	14
80421680	VL 80	nr	1	16
80422400	VL 100	nr	1	24
80424000	VL 150	nr	1	38



80.49 Ricambi e accessori

Codice	Prodotto	U.m.	Conf.	D
80490300	ricambio filettato fustella mm 03	nr	1	3
80490400	ricambio filettato fustella mm 04	nr	1	4
80490500	ricambio filettato fustella mm 05	nr	1	5

Codice	Prodotto	U.m.	Conf.	D
80490550	fustella attacco d.10 forat. mm 05	nr	1	5
80490600	fustella attacco d.10 forat. mm 06	nr	1	6
80490750	fustella attacco d.10 forat. mm 07,5	nr	1	7,5

Codice	Prodotto	U.m.	Conf.
80491100	ricambio punzone per rivetti 33	nr	1
80491101	ricambio punzone per rivetti 36	nr	1
80491102	ricambio punzone per rivetti 37	nr	1

Codice	Prodotto	U.m.	Conf.
80492800	base in ottone per torchio	nr	1



/
OTTANTACINQUE

Accessori

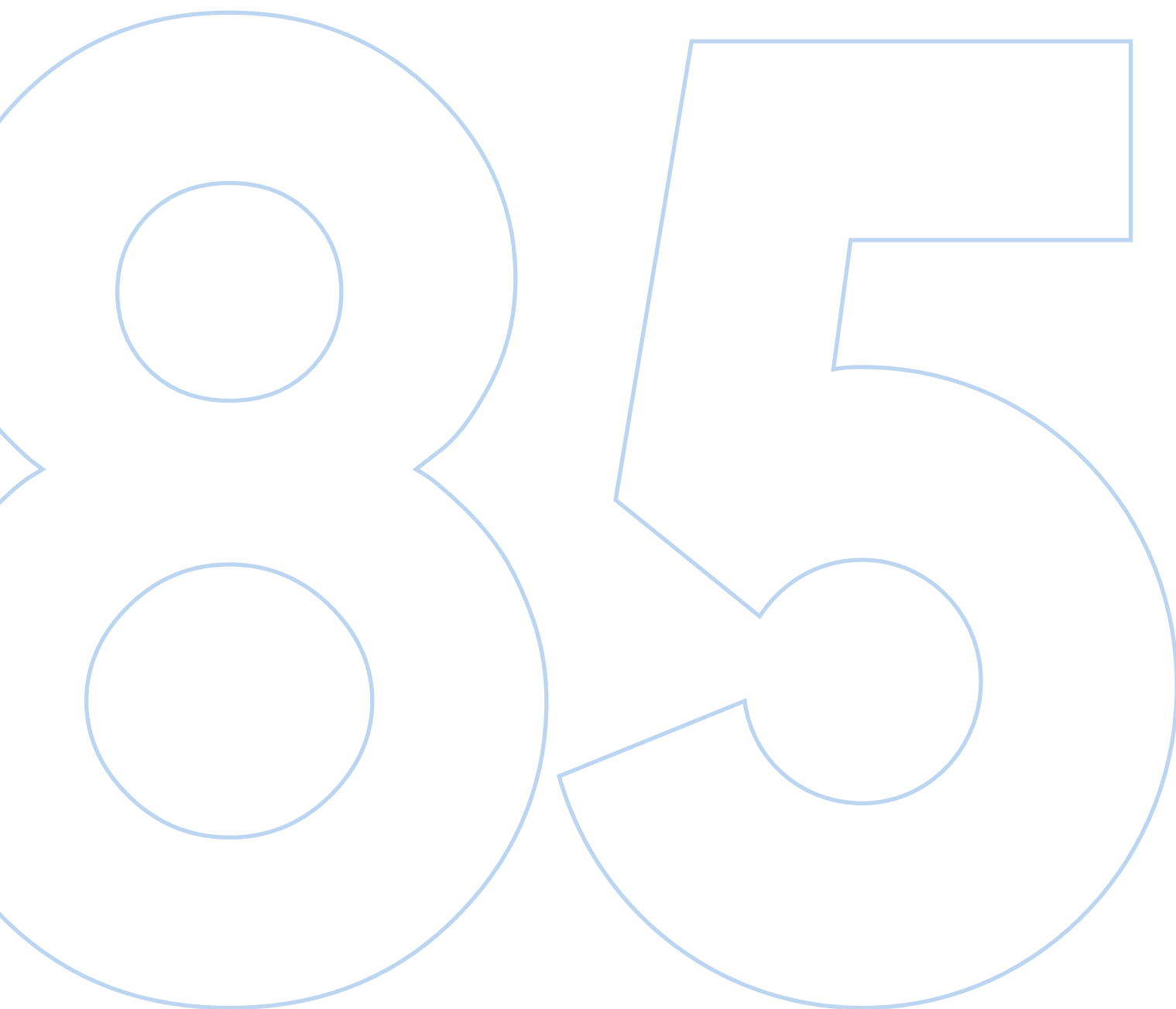

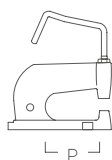

85.01 Torchi

Codice	Prodotto	U.m.	Conf.	P
85010500	torchietto numero 5	nr	1	15 cm

Utilizzabile con punzoni e fustelle per torchio · Indicato per occhielli fino a VL70/mm 16 alluminio

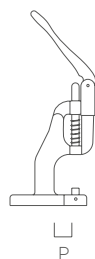

85.01 Torchi per stampa digitale

Codice	Prodotto	U.m.	Conf.	P
85019201	torchio manuale per occhielli	nr	1	5 cm

Utilizzabile con punzoni 80.33



85.01 Torchi per stampa digitale

Codice	Prodotto	U.m.	Conf.	P
85019203	torchio manuale per occhielli	nr	1	10 cm

Utilizzabile con punzoni 80.33 · Indicato per occhielli 01.70





85.01 Torchi

Codice	Prodotto	U.m.	Conf.	P	
850190LE	torchio a leva indicato per occhielli fino a VL100/mm 25	A	nr	1	7 cm
850191LE	regolatore completo	B	nr	1	
850192LE	adattatore	C	nr	1	
850190LER	torchio a leva rinforzato indicato per occhielli fino a VL150/mm 40	nr	1	7 cm	

Utilizzabile con punzoni e fustelle per torchio



85.01 Torchi

Codice	Prodotto	U.m.	Conf.	P
850193LE	torchio a leva indicato per occhielli da mm 3 a VL150/ mm40 e ovali turniquet	nr	1	15 cm

Utilizzabile con punzoni e fustelle per torchio



85.01 Autoperforanti

Codice	Prodotto	U.m.	Conf.	P
850196LE	torchio a leva autoperforante	nr	1	18 cm



Punzone



Matrice

90.01 Stampi

Codice	Prodotto	U.m.	Conf.	D
9001140031	stampo VL 31 AR10	nr	1	08
9001140040	stampo VL 40 AR10	nr	1	10
9001140050	stampo VL 50 AR10	nr	1	12
9001140060	stampo VL 60 AR10	nr	1	14
9001140070	stampo VL 70 AR10	nr	1	16
9001140080	stampo VL 80 AR10	nr	1	18

A richiesta solo parte inferiore (matrice) o solo la parte superiore (punzone)





85.03 Chiavi Clipmax

Codice	Prodotto	U.m.	Conf.
85030504	chiave per avvitare	nr	1



85.05 Pinze

Codice	Prodotto	U.m.	Conf.
85050506	per fascette	nr	1



85.05 Pinze

Codice	Prodotto	U.m.	Conf.
85050507	per punti P7	nr	1



85.05 Pinze

Codice	Prodotto	U.m.	Conf.
85050508	per bottoni senza ricambi	nr	1

Abbinare punzoni per torchio bottoni 80.37



Codice	Prodotto	U.m.	Conf.
85050511	per occhielli e bottoni senza ricambi	nr	1

Per **torchio occhielli tondi** abbinare punzoni 80.31 (max mm18)

Per **torchio bottoni** abbinare punzoni 80.37



85.05 Pinze

Codice	Prodotto	U.m.	Conf.
85050509	multipla a 6 fustelle da 02 a 05 mm	nr	1





85.05 Pinze

Codice	Prodotto	U.m.	Conf.
85050510	per DOT senza ricambi	nr	1
80370040	bottoni Dot parte inferiore	nr	1
80370041	bottoni Dot parte superiore	nr	1



85.07 Piastre PEHD¹ per ribattere

Codice	Prodotto	U.m.	Conf.	L	M
85070125	spessore mm 25	nr	1	25	25
85070130	spessore mm 30	nr	1	25	25
85070140	spessore mm 40	nr	1	25	25

¹ poliestere ad alta densità

85.10 Collanti



A



B



C

Codice	Prodotto	U.m.	Conf.
8510200T	colla per tessuto PVC ml 200	A	nr 1

Codice	Prodotto	U.m.	Conf.
8510070T	colla per tessuto PVC e poliuretani (PU) ml 65	B	nr 1

Codice	Prodotto	U.m.	Conf.
8510860B	colla per tessuto PVC gr. 860	C	nr 1





85.09 Collanti

Codice	Prodotto	U.m.	Conf.
85091380025B	SABA 70T colla per PVC ml 250 con pennello	nr	1
85091380100B	SABA 70T colla per PVC ml 1000	nr	1



85.11 Nastri vari

Codice	Prodotto	U.m.	Conf.
85110600	Idrorepellente BIADESIVO per acrilici - 06 mm x 100mt	nr	1
85110900	Idrorepellente BIADESIVO per acrilici - 09 mm x 100mt	nr	1
85112000	Idrorepellente BIADESIVO per acrilici - 12 mm x 100mt	nr	1



Codice	Prodotto	U.m.	Conf.
8511260T	Trasparente TERMOADESIVO per impermeabilizzare cuciture - 20 mm x 100 mt	nr	1

Codice	Prodotto	U.m.	Conf.
8511271	Trasparente saldabile ARIA CALDA e H.F. per acrilici mm 22 x 100 mt	nr	1

Codice	Prodotto	U.m.	Conf.
8511280	Trasparente saldabile H.F. per acrilici mm17,50x100mt	nr	1



Codice	Prodotto	U.m.	Conf.
85112525	BIADESIVO per PVC - 25 mm x 25 mt	nr	1
85115025	BIADESIVO per PVC - 50 mm x 25 mt	nr	1



Codice	Prodotto	U.m.	Conf.
85116125	BIADESIVO 3M® mm 12 x 33mt sp.mm0,05 per acrilici	nr	1
85116500	Dispenser per nastro adesivo 3M® da mm 12 a 19	nr	1





85.11 Nastri per riparazioni

Prima di applicare si consiglia di pulire bene la parte danneggiata

Codice	Prodotto	U.m.	Conf.
8511906010BI	PVC ADESIVO per riparazioni col.BIANCO h. cm 10 x mt 60	mt	60
8511906010BL	PVC ADESIVO per riparazioni col.BLU h. cm 10 x mt 60	mt	60
8511906010GI	PVC ADESIVO per riparazioni col.GIALLO h. cm 10 x mt 40	mt	40
8511906010GR	PVC ADESIVO per riparazioni col.GRIGIO h. cm 10 x mt 60	mt	60
8511906010RO	PVC ADESIVO per riparazioni col.ROSSO h. cm 10 x mt 60	mt	60
8511906010VL	PVC ADESIVO per riparazioni col.VERDE h. cm 10 x mt 60	mt	60



85.11 Impermeabilizzanti per tessuti acrilici

Codice	Prodotto	U.m.	Conf.
85120400	spray lt 0,40	A	nr 1
85121000	bottiglia lt 1,00	B	nr 1
85121020	tanica lt 20,00	C	nr 1



**TEXTOUT® PER PVC**

Apco Intense Cleaner	Detergente concentrato
----------------------	------------------------

Apco Fast Cleaner	Pulitore pronto all'uso
-------------------	-------------------------

Apco Protectant	Protettivo autolucidante
-----------------	--------------------------

Disponibili in flacone spray no gas 0,75 l
oppure tanica 5 l

A richiesta prodotti per la pulizia APCO

Codice	Prodotto	U.m.	Conf.
85170201	Texout APCO PVC intense cleaner - spray 0,75 lt - no gas	nr	1
85170205	Texout APCO PVC intense cleaner - tanica da 5 lt	nr	1
85170301	Texout APCO PVC fast cleaner - spray 0,75 lt - no gas	nr	1
85170305	Texout APCO PVC fast cleaner - tanica da 5 lt	nr	1
85170401	Texout APCO PVC protectant - spray 0,75 lt - no gas	nr	1
85170405	Texout APCO PVC protectant - tanica da 5 lt	nr	1

**IRISUN® PER ACRILICI**

Apco Fast Cleaner	Detergente liquido
-------------------	--------------------

Apco Protectant	Protettivo repellente all'acqua
-----------------	---------------------------------

Disponibili in flacone spray no gas 0,75 l
oppure tanica 5 l

Codice	Prodotto	U.m.	Conf.
85170001	Irisun APCO Acrilici fast cleaner - spray 0,75 lt - no gas	nr	1
85170005	Irisun APCO Acrilici fast cleaner - tanica da 5 lt	nr	1
85170101	Irisun APCO Acrilici protectant - spray 0,75 lt - no gas	nr	1
85170105	Irisun APCO Acrilici protectant - tanica da 5 lt	nr	1

ottantacinque
→ prodotti Leister®



85



85.65 Prodotti Leister®

Codice	Prodotto	U.m.	Conf.
85650000ST	Triac ST 230 V - 1600 W	nr	1

Fornito con valigetta



85.65 Beccucci

Codice	Prodotto	U.m.	Conf.
85651120L	mm 20	nr	1
85651140L	mm 40	nr	1

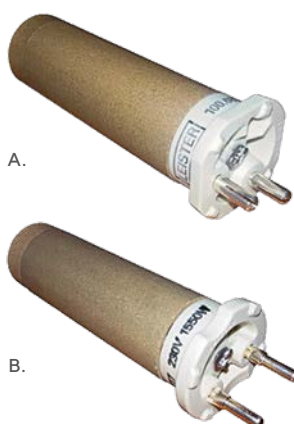

85.65 Ricambi Leister® Triac

Codice	Prodotto	U.m.	Conf.
85652001	carboncino	nr	1
85652010	tubo isolante	nr	1
85652115	resistenza per Triac S watt 1550 (A)	nr	1
85652200	scheda elettronica	nr	1
85652118	resistenza per Triac ST 1550 W (B)	nr	1
85652002	spazzola ottone per saldatrici	nr	1



ottantacinque
→ prodotti Leister®



85



85.65 Rulli al silicone

Codice	Prodotto	U.m.	Conf.
85652503	con sfere 1 braccio mm 28	nr	1
85652504	con sfere 1 braccio mm 43	nr	1



85.65 Rulli in gomma*

Codice	Prodotto	U.m.	Conf.
85652501	senza sfere 1 braccio mm 44	nr	1
85652502	senza sfere 2 braccia mm 44	nr	1

* Prodotti non Leister



ottantacinque
→ prodotti Leister®



85



85.66 Uniplan 300

Codice	Prodotto	U.m.	Conf.
85660040	mm 20	nr	1
85660041	mm 30	nr	1
85660042	mm 40	nr	1



85.66 Uniplan 500

Codice	Prodotto	U.m.	Conf.
85660050	mm 20	nr	1
85660051	mm 30	nr	1
85660052	mm 40	nr	1





85.66 Tapemat

Codice	Prodotto	U.m.	Conf.
85660022	per saldatura cinghia pvc 50 mm	nr	1

Disponibile resistenza di ricambio 400V/3 - 3300W



85.66 Tapemat

Codice	Prodotto	U.m.	Conf.
85660024	Spriegel per saldature PVC 100 mm	nr	1

Disponibile resistenza di ricambio 400V/3 - 3300W
Disponibile anche mm 125



85.66 Variant T1

Codice	Prodotto	U.m.	Conf.
85660028	saldatura Sovrapposizione	nr	1

Disponibile in 4 varianti

230V/3680W nastro mm 25	230V/3680W nastro mm 50
400V/5700W nastro mm 25	400V/5700W nastro mm 50

Altre versioni disponibili a richiesta

Disponibili resistenze di ricambio 230V e 400V



85.66 Variant T1

Codice	Prodotto	U.m.	Conf.
85660029	nastro	nr	1

Disponibile in 4 varianti

230V/3680W nastro mm 25	230V/3680W nastro mm 50
400V/5700W nastro mm 25	400V/5700W nastro mm 50

Altre versioni disponibili a richiesta

Disponibili resistenze di ricambio 230V e 400V



85.66 Hemtek ST

Codice	Prodotto	U.m.	Conf.
85660860	mm 40	nr	1
85660861	mm 30	nr	1
85660862	mm 20	nr	1



Panoramica apparecchi manuali

Tipo di apparecchio	Triac ST
Tensione V~	230
Max. Potenza W	1.600
Temperatura °C	40 - 700
Dimensioni mm (L x Ø)	338 x 90
Impugnatura (Ø)	56
Peso kg (senza di cavo)~	1,0
Marchio di conformità	CE
Marchio di sicurezza	
Tipo di certificazione	
Classe di protezione II	
Applicazioni	
Impiego esterno	✓
Impiego interno	✓
Coperture	✓
Banner pubblicitari / teloni	✓
Ingegneria civile / tunnel / opere idrauliche e discariche	✓
Costruzione di serbatoi e manufatti in plastica	✓
Pavimenti / decorazioni interne	✓
Termo-retrazione	✓
Soffiante integrato	✓
Display digitale	NO

Panoramica delle saldatrici automatiche

Tipo di apparecchio	Variant T1 Sovrapposiz.	Variant T1 Nastro 50 mm	Variant T1 Nastro 25 mm	Tapemat 50 mm	Tapemat Spriegel 100 / 125 mm
Tensione max V~	230 / 400	230 / 400	230 / 400	3x400	3x400
Potenza max W	3.680 / 5.700	3.680 / 5.700	3.680 / 5.700	10.000	10.000
Temperatura °C	100 - 620	100 - 620	100 - 620	650	650
Velocità m/min	1,5 - 18	1,5 - 18	1,5 - 18	4,0 - 20	4,0 - 20
Larghezza di saldatura mm	20 / 40	50	25	50	2x20
Dimensioni (LxPxA) mm	500x400x195	700x415x85	700x415x85	555x435x370	555x435x370
Peso kg	22,5	28,0	28,0	35,0	40,0
Marchio di omologazione	CE	CE	CE	CE	CE
Marchio di sicurezza	Ⓢ	Ⓢ	Ⓢ	Ⓢ	Ⓢ
Tipo di certificazione	CCA	CCA	CCA	CCA	CCA
Classe di protezione	Ⓛ	Ⓛ	Ⓛ	Ⓛ	Ⓛ
Processi di saldatura possibili					
Saldatura a sovrapposizione	✓				
Saldatura a orlatura	✓				
Saldatura di rinforzo	✓				
Saldatura con nastro		✓	✓	✓	✓
Tecnologia degli apparecchi					
Aria calda	✓	✓	✓	✓	✓
Cuneo caldo					
Caratteristiche					
Temperatura regolata	✓	✓	✓		
Motore regolato	✓	✓	✓		
Temperatura e motore regolabili in modo continuo	✓	✓	✓	✓	✓
Display digitale	✓	✓	✓	✓	



Tipo di apparecchio	Uniplan 300	Uniplan 500	Hemtek ST
Tensione max V~	230	230	230
Frequenza Hz	50/60	50/60	50/60
Potenza max W	3.450	3.450	3.450
Lunghezza ugello mm	20 (85660040) 30 (85660041)	20 (85660050) 30 (85660051) 40 (85660052)	40 (85660860) 30 (85660861) 20 (85660862)
Temperatura, continua °C	100 - 620	100 - 620	100 - 650
Quantità d'aria, modo continuo l/min	-	-	1-10
Azionamento, a regolazione continua m/min	1-16	1-16	0.8-12
Numero di giri soffiante rpm	12.500	18.000	-
Motore del soffiante	brushed	brushless (maintenance-free)	-
Livello di emissione Lpa (dB)	70 (K=3dB)	70 (K=3dB)	70 (K=3dB)
Dimensioni (LxPxA) mm	500x310x300	500x310x300	433x350x600
Peso senza cavo (kg)	15	16	27
Marchio di omologazione	CE	CE	CE
Classe di protezione			



85.68 Martelletto pneumatico

Codice	Prodotto	U.m.	Conf.
85680000	per capottine	nr	1
85680009	kit guarnizioni per martelletto capottine	nr	1
85680100	testa di ricambio blu		



85.69 Coltello elettrico per tessuti acrilici/sintetici

Codice	Prodotto	U.m.	Conf.
85690000	senza lama	nr	1
85690100	lama per coltello elettrico	nr	1



85.75 Lastre isolanti per saldatrici

Codice	Prodotto	U.m.	Conf.	gr/mt
85750190	MYLAR® mm 0,19 - h cm 100	kg	a misura	270
85750250	MYLAR® mm 0,25 - h cm 100	kg	a misura	360
85750500	mm 0,50 - cm 120x100	nr	1	1200
85750800	mm 0,80 - cm 120x100	nr	1	2000
85751000	mm 1,00 - cm 120x100	nr	1	2500



85.75 Isolanti Teflon adesivi

Codice	Prodotto	U.m.	Conf.	gr/mt
85750330	spessore mm 0,13 - h cm 3	kg	1	30
85750350	spessore mm 0,13 - h cm 5	kg	1	30
85750360	spessore mm 0,25 - h cm 10	nr	1	15



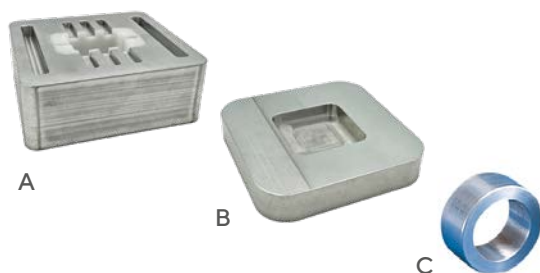

85.77 Elettrodi

Codice	Prodotto	U.m.	Conf.
85770500	per saldare campanelle con anello	A	nr 1
85770800	per saldare campanelle copri/scopri	B	nr 1
85771000	per saldare tappi piscina	C	nr 1



85.83 Forbici

Codice	Prodotto	U.m.	Conf.
85830008	8 pollici	nr	1
85830009	9 pollici	nr	1
85830010	10 pollici	nr	1
85830011	10 pollici per mancini	nr	1
85830012	12 pollici	nr	1
85830081	8 pollici per mancini	nr	1



85.83 Forbici Kay

Codice	Prodotto	U.m.	Conf.
85837250	lama acciaio inox 10 pollici	nr	1
85837250L	lama acciaio inox 10 pollici per mancini	nr	1
85837300	lama acciaio inox 12 pollici	nr	1



85.83 Taglierino

Codice	Prodotto	U.m.	Conf.
85838000	taglierino lama rotante	nr	1
85838001	lama di ricambio	nr	1



85.90 Chiodatrici

Codice	Prodotto	U.m.	Conf.
85900080	per punti metallici da 80	nr	1
85900090	per punti metallici da 90	nr	1
85900092	per punti metallici da 92	nr	1

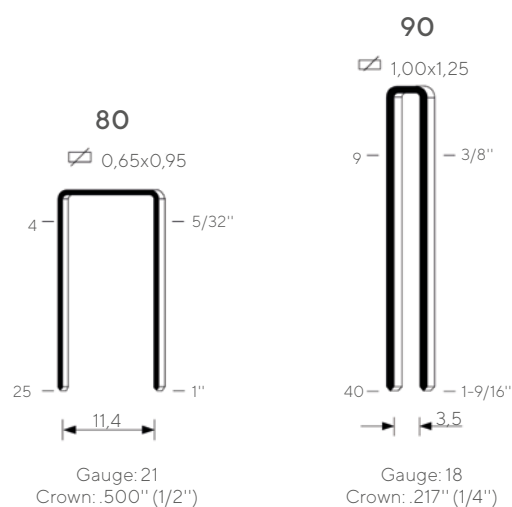

05.50 Punti per chiodatrice

Codice	Prodotto	U.m.	Conf.
05508006	80/06 f.z.	conf.	10.000
05508008	80/08 f.z.	conf.	21.600
05508008AI	80/08 acciaio inox	conf.	10.000
05508012	80/12 f.z.	conf.	10.000
05509009	90/09 f.z.	conf.	10.000
05509015	90/15 f.z.	conf.	5.000
05509209	92/09 f.z.	conf.	10.000
05509209AI	92/09 acciaio inox	conf.	10.000
05509212	92/12 f.z.	conf.	10.000

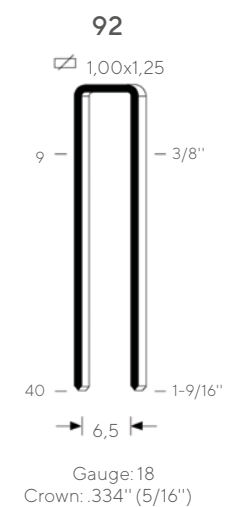



85.90 Rivettatrici

Codice	Prodotto	U.m.	Conf.
85900205	rivettatrice RIV 5 manuale per rivetti a strappo da 2,4 a 4,8 all.	nr	1

Codice	Prodotto	U.m.	Conf.
85900503	Rivettatrice 503 oleopneumatica per rivetti a strappo fino al d.4,8 (tutte le leghe) e d.6,0 solo alluminio	nr	1

Codice	Prodotto	U.m.	Conf.
85900504	Rivettatrice 504 oleopneumatica per rivetti a strappo fino al d. 6,4 (tutte le leghe)	nr	1

Codice	Prodotto	U.m.	Conf.
85900508	Rivettatrice 508 oleopneumatica per rivetti e bulloni a strappo fino al d. 6,4 (tutte le leghe)	nr	1

Codice	Prodotto	U.m.	Conf.
85900720	Rivettatrice 720 Batteria Litio 18.0V 2,0Ah per rivetti a strappo fino d.6,4 con 2 batterie + caricabatteria	nr	1





90.01 Occhiellatrici autopercoranti

Codice	Prodotto	U.m.	Conf.
90010118	AR10 pneumatica per occhielli da mm 10 a mm 18 e ovali turniquet	nr	1

PNEUMATICA AUTOPERFORANTE

Dimensioni	P720 x L450 x H500 mm
Peso	40 kg
Pressione di esercizio	7 Bar
Profondità di lavoro	0-180 mm
Funzionamento	Pneumatico con comando a pedale

Codice	Prodotto	U.m.	Conf.
90010118P	AR10/P pesante pneumatica solo per occhielli VL100 - mm 25 oppure VL150 - mm 40	nr	1



Punzone

Matrice

90.01 Stampi per modello AR10

Codice	Prodotto	U.m.	Conf.	D
9001140031	stampo VL 31	nr	1	08
9001140040	stampo VL 40	nr	1	10
9001140050	stampo VL 50	nr	1	12
9001140060	stampo VL 60	nr	1	14
9001140070	stampo VL 70	nr	1	16
9001140080	stampo VL 80	nr	1	18
9001140150	stampo VL 150 AR10/P	nr	1	40
9001140TIR	stampo TIR Ovale AR10/P	nr	1	42x22

A richiesta solo parte inferiore (matrice) o solo la parte superiore (punzone)



90.01 Occhiellatrici autoperforanti

Codice	Prodotto	U.m.	Conf.
90010200TR	AR20 su carrello	nr	1

Articoli applicabili: occhielli tondi/ovali/rettangolari, cavallotti, ganci nylon e f.z., carrucole, tourniquet.

AUTOPERFORANTE OLEODINAMICA

Dimensioni	P800 x L470 x H900 mm
Peso	115 Kg (a secco)
Tensione	Trifase 380 Volt (standard), Monofase 220 Volt (a richiesta)
Potenza motore elettrico	KW 1,5
Potenza Max	200 Bar
Pressione di esercizio	150 Bar
Portata olio centralina	10 kg
Rumorosità	40 dB (solo in fase di lavoro)
Profondità di lavoro	0-200 mm

Pulsantiera di comando e quadro comandi alimentati con tensione a 24 V a norma CE





90.01 Occhiellatrici autopercoranti

Codice	Prodotto	U.m.	Conf.
90010300A	AR30	nr	1

Articoli applicabili: occhielli tondi/ovali/rettangolari, cavallotti, ganci nylon e f.z., carrucole, tourniquet.

AUTOPERFORANTE OLEODINAMICA

Dimensioni	P700 x L550 x H1650 mm
Peso	270 kg
Tensione	Trifase 380 Volt (standard), Monofase 220 Volt (a richiesta)
Potenza motore elettrico	KW 1,5
Potenza Max	200 Bar
Pressione di esercizio	150 Bar
Portata olio centralina	40 kg
Rumorosità	60 dB (solo in fase di lavoro)
Profondità di lavoro	0-300 mm

Pulsantiera di comando e quadro comandi alimentati con tensione a 24 V a norma CE



90.01 Stampi per modello AR20/AR30

Codice	Prodotto	U.m.	Conf.
9001135040	per occhiello mm 10	nr	1
9001135050	per occhiello mm 12	nr	1
9001135060	per occhiello mm 14	nr	1
9001135070	per occhiello mm 16	nr	1
9001135080	per occhiello mm 18	nr	1
9001135100	per occhiello mm 24	nr	1
9001135150	per occhiello mm 40	nr	1

A richiesta solo parte inferiore (matrice) o solo la parte superiore (punzone)



90.01 Stampi per modello AR20/AR30

Codice	Prodotto	U.m.	Conf.
90011352213	stampo occhiello tourniquet mm 22,50x13,50	nr	1
9001135242	stampo TIR ovale 42x22	nr	1
9001135326	stampo carrucole mm 15	nr	1
9001135327	stampo carrucole mm 24 25022400	nr	1
9001135328	stampo carrucole mm 24 25022402	nr	1
9001135329	stampo gancio interasse mm 20	nr	1
9001135330	stampo cavallotti interasse mm 51	nr	1
9001135331	stampo carrucole mm 24 25022402NY	nr	1

A richiesta solo parte inferiore (matrice) o solo la parte superiore (punzone)

Altri stampi a richiesta





90.01 Occhiellatrici automatiche autopercoranti

Codice	Prodotto	U.m.	Conf.
900104085	AR40 - profondità 25 cm	nr	1

Per occhielli serie VL e serie E - da 10 a 18 mm

Occhiellatrice perforante con alimentazione contemporanea di occhielli e ranelle, concepita per ottenere livelli produttivi elevatissimi.

Dimensioni	P100 x L110 x H195 cm
Peso	220 kg
Tensione	220 Volt monofase
Potenza motore elettrico	1.1 Kw
Rumorosità	35/40 db
Profondità d'applicazione	0-250 mm

Pulsantiera di comando e quadro comandi alimentati con tensione a 24 V a norma CE

Puntatore laser di serie



90.01 Occhiellatrici automatiche autopercoranti

Codice	Prodotto	U.m.	Conf.
900104086	occhiellatrice AR50 - profondità 5 cm	nr	1

Per occhielli serie VL e serie E - da 10 a 18 mm

Occhiellatrice perforante con alimentazione contemporanea di occhielli e ranelle, consente di ottenere livelli produttivi elevatissimi nell'inserimento di occhielli serie VL e serie E, da 10 a 18 mm.

Dimensioni	P80 x L110 x H195 cm
Peso	180 kg
Tensione	220 Volt monofase
Potenza motore elettrico	1.1 Kw
Rumorosità	35/40 db
Profondità d'applicazione	0-50 mm

Pulsantiera di comando e pedale di azionamento alimentati con tensione a 24 V a norma CE.

Puntatore laser di serie



90.01 Occhiellatrici automatiche autoperforanti a 1 caricatore

Codice	Prodotto	U.m.	Conf.
900104087	Occhiellatrice AR50 a un caricatore	nr	1

Dimensioni P80 x L110 x H195 cm

Peso 150 kg

Tensione 220 Volt monofase

Potenza motore elettrico 1.1 Kw

Rumorosità 35/40 db

Profondità d'applicazione 0-50 mm

Puntatore laser di serie



INFORMAZIONI LEGALI E CONDIZIONI DI VENDITA

I diritti di pubblicazione di questo catalogo sono di proprietà di ARTECA SpA
È vietata qualsiasi riproduzione anche parziale. Tutti i diritti riservati.

Le caratteristiche tecniche ed estetiche degli articoli di questo catalogo sono indicative e possono variare senza preavviso in qualsiasi momento.

ARTECA SpA NON si assume alcuna responsabilità per l'uso improprio dei prodotti.

ARTECA SpA non può assumersi alcun tipo di responsabilità per le informazioni fornite in questo catalogo. Le specifiche, dimensioni e pesi forniti nel presente catalogo sono approssimative e vanno utilizzate a titolo indicativo.

La merce si intende resa franco nostro magazzino Barlassina (MB).

I rischi derivanti dal trasporto della merce sono a totale carico dell'acquirente.

Eventuali resi e/o reclami devono essere da noi autorizzati e si intendono resi franco ns. magazzino Barlassina (MB) non oltre 30 gg. dalla data di acquisto. Non si accettano reclami trascorsi 8 gg. dalla consegna della merce.

Eventuali ritardi nei pagamenti autorizzano l'azienda a richiedere il pagamento degli interessi moratori ex D.LGS. 231/2002.

tutti i nostri materiali sono venduti con patto di riservato dominio. Sino a che non saranno integralmente pagate le fatture nei termini previsti dal contratto, i materiali s'intendono di nostra proprietà. Se alla scadenza del termine la parte acquirente non avrà corrisposto, in tutto o in parte, il prezzo pattuito, la parte acquirente avrà facoltà di ritenere risolta la vendita e di riprendere la merce venduta. In tal caso, tutte le spese di riconsegna della merce graveranno sulla parte acquirente. Qualora la merce fornita sia stata utilizzata dalla parte acquirente per la fabbricazione di altri prodotti, la parte venditrice potrà rivalersi anche su questi, secondo modalità che saranno precisate dell'autorità giudiziaria adita. Viene inoltre espressamente convenuto che, risolto il contratto per inadempimento da parte del compratore della obbligazione di pagamento, ARTECA SpA potrà ritenere, a titolo di indennità, quanto già riscosso salvo il maggior danno.

Per ogni controversia è competente il Foro di Monza.

CREDITS

Catalogue design

Idem Design

Art direction

Flavio Sisto

Creative design

Rossella Pellegrini, Luigi Giannuzzi

Product photography

Antonio Giacummo

Editing & retouching

Rossella Pellegrini

Team Arteca

Manuela Villa, Andrea Spinelli

www.artecaitalia.it



www.artecaitalia.it



Arteca S.p.A.
Via Bellisario, 1
20825 Barlassina, MB · Italia
T +39 0362 523527
F +39 0362 551487
E info@artecaitalia.it

WORLDWIDE NETWORK

FRANCE

E info@giofex.fr
W www.giofex.fr

GERMANY

E info@giofex.de
W www.giofex.de

SLOVAKIA

E info@giofex.sk
W www.giofex.sk

UNITED KINGDOM

E info@giofex.co.uk
W www.giofex.co.uk

ROMANIA

E office@polytex.ro
W www.polytex.ro

BULGARIA

E info@giofex.bg
W www.giofex.bg

